



Contractor Select™

QTE LED

Floodlights

The QTE LED floodlight is ideal to replace up to 500W Halogen lamps, and comes with knuckle or yoke mount options. This is an extremely cost effective solution, great for illuminating yards, driveways, signage, patios, warehouses as well as for security applications.

FEATURES:

- Replaces up to 500W Quartz Halogen, saves 80% energy
- Knuckle and yoke mount options available, good for ground mount as well!
- Cost effective and energy efficient, payback within one year



Catalog Number	UPC	Description	Replaces Up To	Lumens	Input Watts	CCT	Voltage	Finish	Pallet Qty
QTE LED P1 40K 120 THK DDB	191848090787	FLOODLIGHTS	150W HALOGEN	2,500	24W	4000K	120V	DARK BRONZE	60
QTE LED P1 40K 120 THK WH	191848090893	FLOODLIGHTS	150W HALOGEN	2,500	24W	4000K	120V	WHITE	60
QTE LED P2 40K 120 THK DDB	191848093436	FLOODLIGHTS	300W HALOGEN	4,000	40W	4000K	120V	DARK BRONZE	60
QTE LED P2 50K 120 YK DDB	191848093535	FLOODLIGHTS	300W HALOGEN	4,000	40W	5000K	120V	DARK BRONZE	60
QTE LED P3 40K 120 THK DDB	191848092590	FLOODLIGHTS	250W METAL HALIDE / 500W HALOGEN	6,750	66W	4000K	120V	DARK BRONZE	60
QTE LED P3 40K 120 YK DDB	191848092606	FLOODLIGHTS	250W METAL HALIDE / 500W HALOGEN	6,750	66W	4000K	120V	DARK BRONZE	60



Specifications

INTENDED USE:

QTE LED is suitable for replacing up to 500W Quartz Halogen or 250W Metal Halide. It is ideal for landscape, signage, and general purpose lighting in commercial and residential applications.

CONSTRUCTION:

Die-cast aluminum housing has integral heat sink fins to optimize thermal management. Rated for -40°C to 40°C ambient temperature. Tempered glass lens is fully gasketed. Available with knuckle and yoke mount.

ELECTRICAL:

LEDs are directly coupled to the housing to maximize heat dissipation and lifespan (L70 / 50,000 hrs). 6 kV surge protection.

INSTALLATION

Mounts easily to junction box or under building cove. Suitable for ground mount applications.

LISTINGS:

UL Certified to US and Canadian safety standards. Wet location listed.

DesignLights Consortium® (DLC) qualified product. Not all versions of this product may be DLC qualified. Please check the DLC Qualified Products List to confirm which versions are qualified.

WARRANTY:

5-year limited warranty.

Note: Actual performance may differ as a result of end-user environment and application. All values are design or typical values, measured under laboratory conditions at 25 °C. Specifications subject to change without notice.

Dimensions

All dimensions are inches (centimeters) unless otherwise indicated.

QTE P1-P2 KNUCKLE

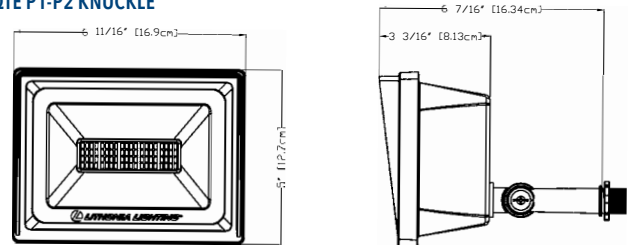

QTE P1-P2 YOKE

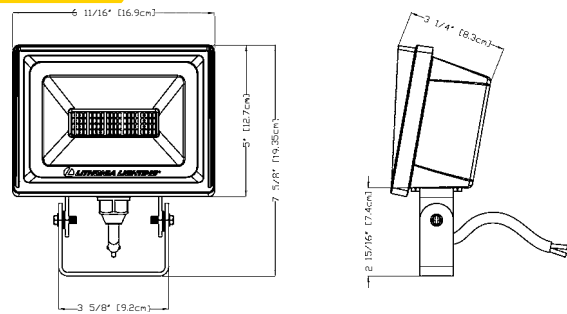

QTE P3 KNUCKLE

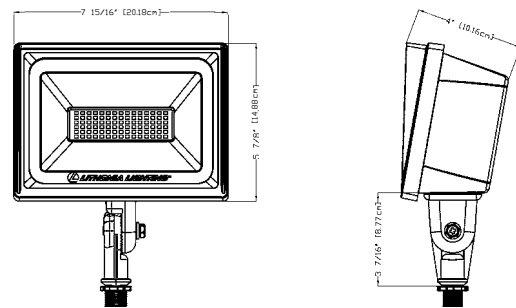

QTE P3 YOKE

