

LED SMALL FLOOD
FLS SERIES, GENERATION 2



15W



20W



40W



50W



PRODUCT DESCRIPTION:

The LED Small Floods are efficient, energy-saving replacements for metal halide and quartz halogen fixtures. Each luminaire features an integral listed driver, potted within a separate compartment to ensure cool operation and longer lifetime. The 15-, 20-, 40-, and 50-watt luminaires can mount at a broad range of angles with a yoke style arm and a 1/2" NPT threaded nipple.

FEATURES:

- Replaces 100 watt quartz halogen through 250 watt metal halide lamps
- Greater than 250,000 hours L70 lifetime, TM-21 calculated method @ 40°C
- Sealed fixture is dirt and bug free
- 5 year warranty

CONTROLS:

120-277VAC Photocontrol: Voltage-specific photocontrols power the fixture when light levels reach 20 lux or below, and turn it off at 30 lux or higher. Photocell mounted externally. Option is available only with 40W and 50W models. Cap included if PC functionality is not required.

MOUNTING:

All models come standard with a yoke and a 1/2" NPT strain relief fitting for easy installation



1/2" threaded nipple allows for easy installation to weather proof boxes or landscape mounting posts.

See page 3 for dimensions

MODEL SELECTION (Full list of order codes on pg. 2)

Typical order example: FLS20U50B

FLS		U		B			/G2
FAMILY	NOMINAL POWER, EQUIVALENCY	VOLTAGE	CCT	FINISH	DISTRIBUTION	CONTROLS	GENERATION
FLS= Small Flood	15= 15W, 100W Quartz Halogen equivalent 20= 20W, 150W Metal Halide equivalent ¹ 40= 40W, 175W Quartz Halogen equivalent 50= 50W, 250W Metal Halide equivalent	U= 120-277V	40= 4000K 50= 5000K	B= Bronze, std	(OMIT)= Wide N= Narrow	(OMIT)= None *P1= 120-277V Photocell	/G2= Gen 2

ACCESSORIES

ORDER CODE	MODEL NUMBER	DESCRIPTION	ACCESSORIES IMAGE
101679	TR2.37BZ	Tennon Reducer, 2-3/8" to 1/2", Bronze	

¹120-277V button photocell available only on 40W and 50W models.

SPECIFICATIONS:

ITEM	SPECIFICATION	DETAILS							
		15W WIDE	20W WIDE	40W WIDE	50W WIDE	15W NARROW	20W NARROW	40W NARROW	50W NARROW
	Input Power (W)	15	20	40	50	15	20	40	50
	Lumens Delivered, 4000K (lm)	1475	2182	4460	5750	1555	2315	4715	5880
	Efficacy (lm/W)	Up to 124 lm/ W							
	Lumen Maintenance (L70 hours)	>250,000 hours @ 40°C*							
	Color Rendering Index (CRI)	≥70							
	CCT	4000K, 5000K							
	Color Consistency	Proprietary binning for uniform color							
	THD	<15%							
ELECTRICAL	Power Factor	0.90							
	Input Voltage (V)	100-277V, 50/60Hz							
PHYSICAL	Housing	Die-cast aluminum							
	Lens	Tempered Glass							
	Mounting	Yoke with ½" threaded fitting							
QUALIFICATION	Qualification	cULus, DLC Premium							
	Environment	Outdoor, wet locations							
	Warranty	5 Year							

*Narrow beam options are special order. Please consult a MaxLite representative for lead times and quantities.

*Lumen Maintenance Based on Calculated Method

ORDERING:

ORDER CODE	MODEL	DISTRIBUTION	NOMINAL POWER (WATTS)	FINISH	CCT
100566	FLS15U40B/G2	WIDE	15W	BRONZE	4000K
100567	FLS20U40B/G2	WIDE	20W	BRONZE	
100568	FLS40U40B/G2	WIDE	40W	BRONZE	
100776	FLS40U40BP1/G2	WIDE	40W	BRONZE	
100569	FLS50U40B/G2	WIDE	50W	BRONZE	
100777	FLS50U40BP1/G2	WIDE	50W	BRONZE	
14098953	FLS15U50B/G2	WIDE	15W	BRONZE	5000K
14098954	FLS20U50B/G2	WIDE	20W	BRONZE	
14098955	FLS40U50B/G2	WIDE	40W	BRONZE	
14098959	FLS40U50BP1/G2	WIDE	40W	BRONZE	
14098960	FLS50U50BP1/G2	WIDE	50W	BRONZE	

DIMENSIONS:

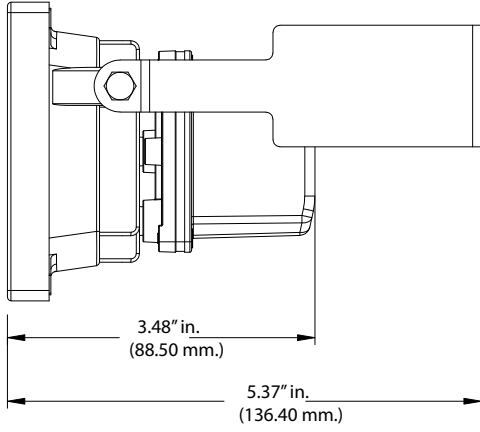

15W

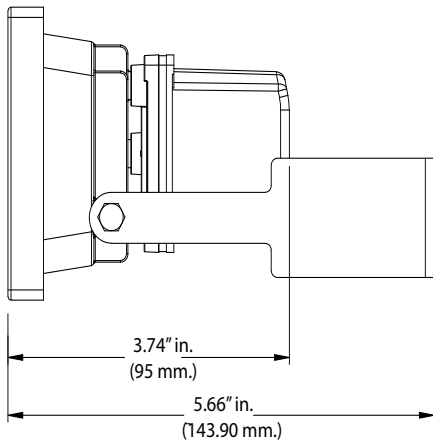
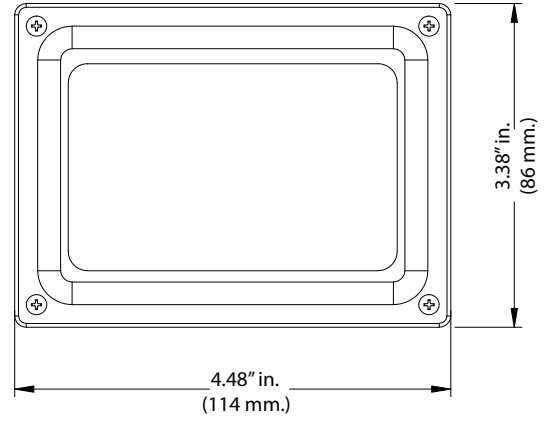

20W

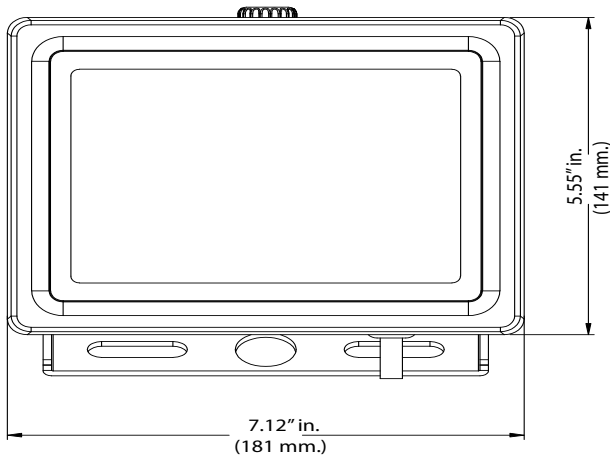
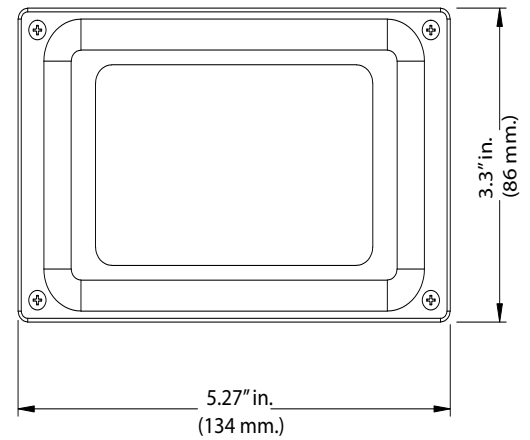

40W

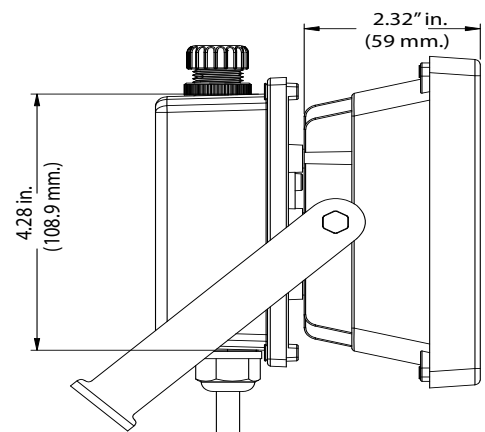

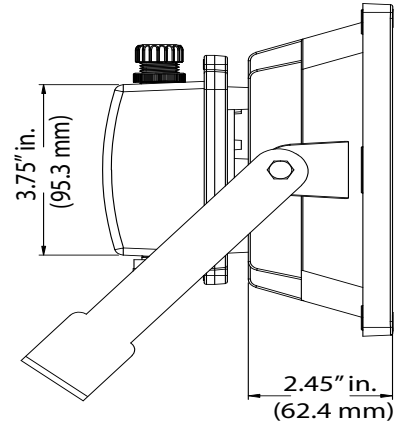
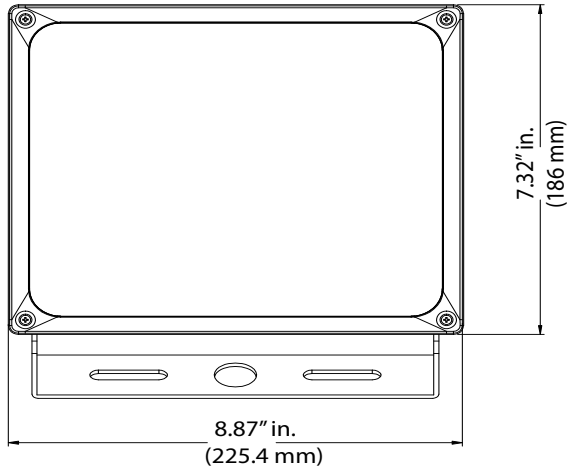

50W