

# LED

## Linear Light Fixture

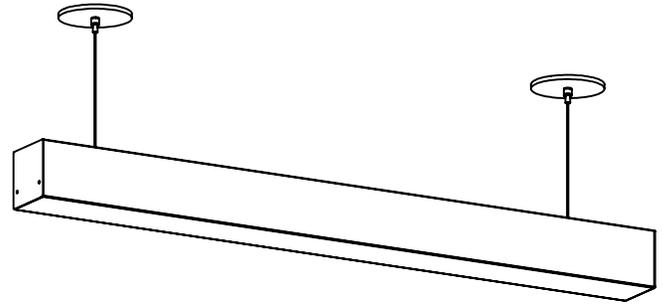

### INSTALLATION INSTRUCTIONS FOR THE 23P,44P&66P,BYB,SES SERIES FIXTURES

APPLICATION: General/Perimeter Lighting



#### STOP! - READ THIS FIRST! - IMPORTANT SAFETY INSTRUCTIONS!

- For information on how to recycle LED/Fluorescent electronic products, please visit [www.epa.gov](http://www.epa.gov).
- Do not install damaged product. This fixture is properly packed to prevent damage during transit.
- All wiring connections should be capped with UL approved recognized wire connectors.
- Do not touch LED diodes or any connecting clips; these parts are very sensitive.
- Do not exceed maximum wattage marked on fixture label.

Carefully read the instructions pertaining to your fixture thoroughly. <b>IF YOU HAVE ANY QUESTIONS REGARDING THE PROPER INSTALLATION OR LOCAL CODES, CONSULT A QUALIFIED ELECTRICIAN.</b>	Injury to persons and damage to the fixture and/or mounting surface may occur if the fixture is pulled from the surface. To reduce risk of injury or damage, mount only to a mechanically sound surface.
Both cord set and hard wired fixtures are intended for connection to a grounded, three-wire source of supply.	Install and wire the fixture in locations in accordance with all national, state and local codes.
Do not install outdoors or in applications other than intended use.	To avoid shock hazard, do not work with live electrical wires.
Ensure fixture is properly grounded before testing.	This fixture is intended for dry applications only.



**WARNING:** THIS PRODUCT MUST BE INSTALLED IN ACCORDANCE WITH THE APPLICABLE INSTALLATION CODE BY A PERSON FAMILIAR WITH THE CONSTRUCTIONS AND OPERATIONS OF THE PRODUCT AND THE HAZARDS INVOLVED.



**WARNING:** RISK OF FIRE; MINIMUM OF 90°C SUPPLY CONDUCTOR SHOULD BE USED. CONSULT A QUALIFIED ELECTRICIAN TO ENSURE CORRECT BRANCH CIRCUIT CONDUCTOR.



**WARNING:** TO AVOID ELECTRIC SHOCK HAZARD, DISCONNECT THE POWER AT THE PANEL BOARD (CIRCUIT BREAKER BOX) BEFORE BEGINNING INSTALLATION.



**WARNING:** TO AVOID FIRE HAZARD RISK, WHEN INSTALLING HARD WIRED UNITS, BE AWARE IF SUPPLY WIRES ARE LOCATED WITHIN THREE INCHES OF BALLAST. IF SO, USE WIRE RATED FOR AT LEAST 90°C (194°F). IF UNSURE, CONSULT A QUALIFIED ELECTRICIAN BEFORE INSTALLING.

**1**



**REMINDER: TO AVOID ELECTRIC SHOCK HAZARD, DISCONNECT THE POWER AT THE PANEL BOARD (CIRCUIT BOX) BEFORE BEGINNING INSTALLATION!**

**2**

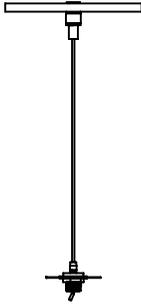

Install fixture hanging kit to ceiling in desired locations. See HC-301/302 assembly instructions for details (HC-301/302-PF Power-feed optional).

**3**

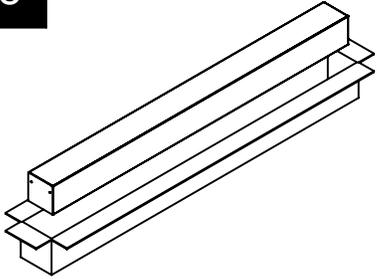

Carefully remove fixture from packaging. Use gloves to prevent dirt and oils from transferring to the unit. Inspect the fixture for any defects before proceeding.

**4**

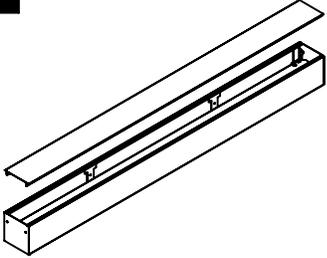

**CAUTION: EDGES MAY BE SHARP:** Carefully remove lens from fixture by gently un-snapping one side at a time, and set aside.

**5**

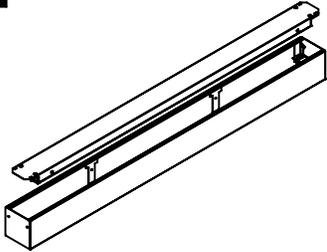

Remove LED assembly and set aside.

**6**

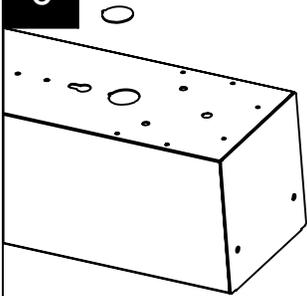

If using HC-301/302-PF, remove 7/8" knockout from fixture in desired location to allow for wiring.

**7**

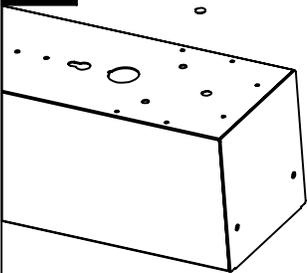

Remove 1/2" knockout from fixture on both ends.

**8**

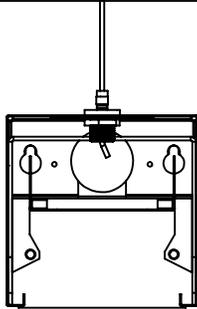

Bring stud of hanging kit through 1/2" knock-out and secure using nut provided.

**9**

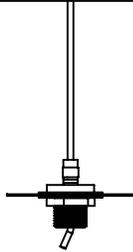

Depress cable clutch ass'y on top of hanging kit stud and slide up hanging cable to desired height (see HC-301/302 assembly instructions for details).

**10**

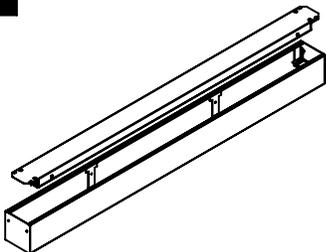

Wire fixture according to all national, state and local codes. Re-install LED ass'y and test fixture.

**11**

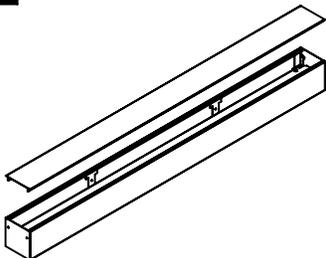

**CAUTION: EDGES MAY BE SHARP:** Carefully re-insert lens by gently snapping in one side at a time.

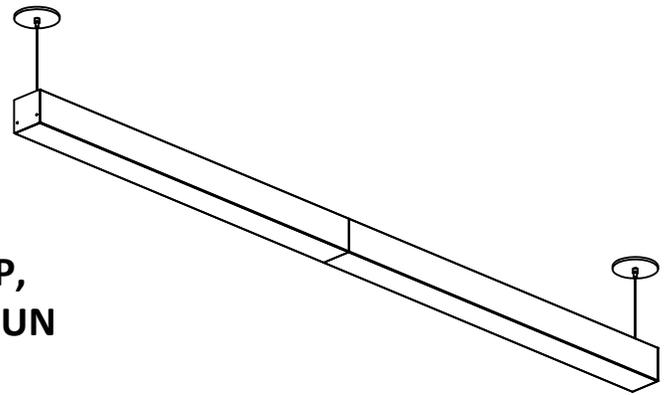

## INSTALLATION INSTRUCTIONS FOR THE 23P, 44P & 66P, BYB, SES SERIES-CONTINUOUS RUN

**APPLICATION:** General/Perimeter Lighting



### STOP! - READ THIS FIRST! - IMPORTANT SAFETY INSTRUCTIONS!

- For information on how to recycle LED/Fluorescent electronic products, please visit [www.epa.gov](http://www.epa.gov).
- Do not install damaged product. This fixture is properly packed to prevent damage during transit.
- All wiring connections should be capped with UL approved recognized wire connectors.
- Do not touch LED diodes or any connecting clips; these parts are very sensitive.
- Do not exceed maximum wattage marked on fixture label.

Carefully read the instructions pertaining to your fixture thoroughly. <b>IF YOU HAVE ANY QUESTIONS REGARDING THE PROPER INSTALLATION OR LOCAL CODES, CONSULT A QUALIFIED ELECTRICIAN.</b>	Injury to persons and damage to the fixture and/or mounting surface may occur if the fixture is pulled from the surface. To reduce risk of injury or damage, mount only to a mechanically sound surface.
Both cord set and hard wired fixtures are intended for connection to a grounded, three-wire source of supply.	Install and wire the fixture in locations in accordance with all national, state and local codes.
Do not install outdoors or in applications other than intended use.	To avoid shock hazard, do not work with live electrical wires.
Ensure fixture is properly grounded before testing.	This fixture is intended for dry applications only.



**WARNING:** THIS PRODUCT MUST BE INSTALLED IN ACCORDANCE WITH THE APPLICABLE INSTALLATION CODE BY A PERSON FAMILIAR WITH THE CONSTRUCTIONS AND OPERATIONS OF THE PRODUCT AND THE HAZARDS INVOLVED.



**WARNING:** RISK OF FIRE; MINIMUM OF 90°C SUPPLY CONDUCTOR SHOULD BE USED. CONSULT A QUALIFIED ELECTRICIAN TO ENSURE CORRECT BRANCH CIRCUIT CONDUCTOR.



**WARNING:** TO AVOID ELECTRIC SHOCK HAZARD, DISCONNECT THE POWER AT THE PANEL BOARD (CIRCUIT BREAKER BOX) BEFORE BEGINNING INSTALLATION.



**WARNING:** TO AVOID FIRE HAZARD RISK, WHEN INSTALLING HARD WIRED UNITS, BE AWARE IF SUPPLY WIRES ARE LOCATED WITHIN THREE INCHES OF BALLAST. IF SO, USE WIRE RATED FOR AT LEAST 90°C (194°F). IF UNSURE, CONSULT A QUALIFIED ELECTRICIAN BEFORE INSTALLING.

**1**



**REMINDER:** TO AVOID ELECTRIC SHOCK HAZARD, DISCONNECT THE POWER AT THE PANEL BOARD (CIRCUIT BOX) BEFORE BEGINNING INSTALLATION!

**2**

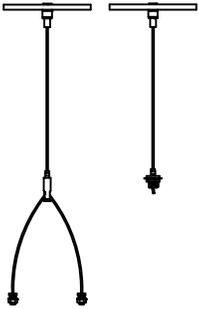

Install fixture hanging kit to ceiling panel in desired location. See HC-301/302 & HC-401/402 assembly instructions for details (HC-301/302-PF Power-Feed optional).

**3**

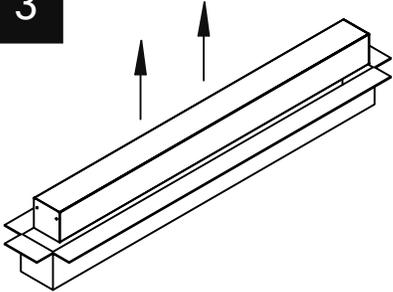

Carefully remove fixture from packaging. Use gloves to prevent dirt and oils from transferring to the unit. Inspect the fixture for any defects before proceeding.

**4**

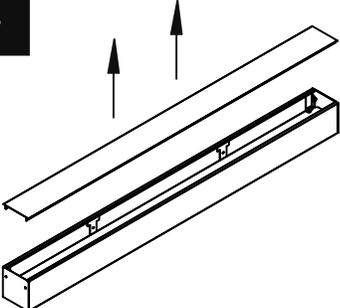

**CAUTION: EDGES MAY BE SHARP:** Carefully remove lens from fixture by gently un-snapping one side at a time, and set aside.

**5**

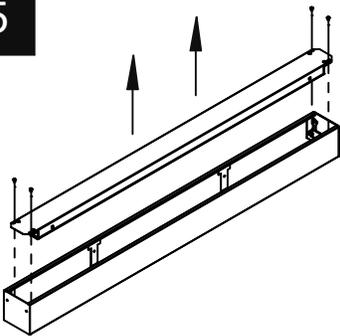

Remove driver cover by removing #8 screws.

**6**

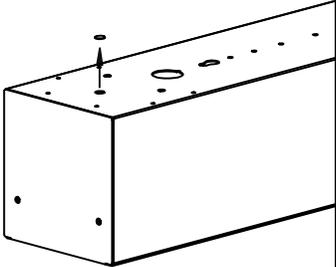

Remove 1/2" knock-outs to allow for hanging kit.

**7**

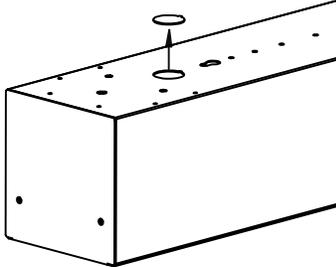

If using Power-Feed hanging kit (HC-301/302-PF), remove 7/8" knock-out from top of fixture on desired end.

**8**

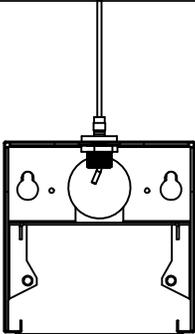

Bring end of hanging kit thru 1/2" knock-out and secure using nut provided (additional help may be required).

**9**

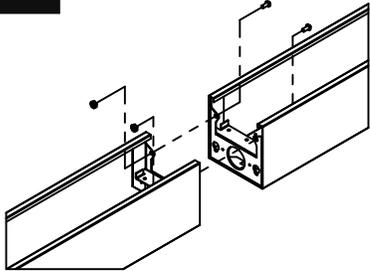

Line up fixtures end to end and bolt together as shown.

**10**

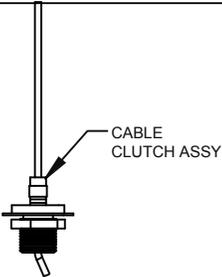

Depress cable clutch assembly on top of hanging kit stud and slide up pendant cable to desired height (see HC301/302 assembly instructions for details).

**11**

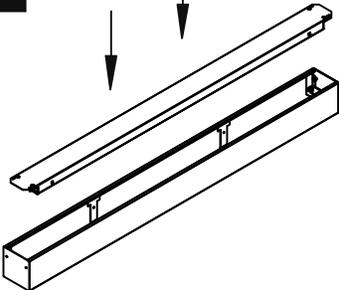

Wire fixture according to all national, state and local codes and re-install driver cover. Test fixture.

**12**

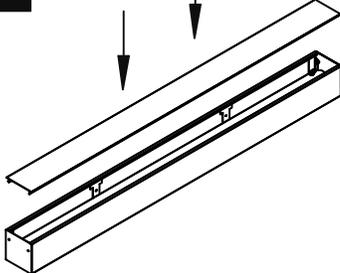

**CAUTION: EDGES MAY BE SHARP:** Carefully re-insert lens to fixture by gently snapping one side at a time.