



8RB Series

96 in. LED Retrofit Kit



FEATURES & SPECIFICATIONS

INTENDED USE

Ballast retrofit kit, 96 in. long, converts an existing strip to carry standard lamps. Material is die-formed 22 gage steel, with high reflectance baked white enamel finish.



ORDERING INFORMATION

STANDARD

Example: **8RB421F48W4800LDMV40K**

8RB	501	F97W13000L	DMV	30K
Series	Width	Wattage and Lumen	Driver	Kelvin Temperature
8RB 96 in.	421 4.25 in. 501 5.00 in.	F32W3450L 32 System Watts, 3450 Delivered Lumens F48W5650L 48 System Watts, 5650 Delivered Lumens F97W11300L 97 System Watts, 11300 Delivered Lumens F114W12800L 114 System Watts, 12800 Delivered Lumens F118W15500L 118 System Watts, 15500 Delivered Lumens	DMV 0-10V Dimming *Field installed-Dimming Wire DMVFID 0-10V Dimming *Factory installed-Dimming Wire	30K 3000K 35K 3500K 40K 4000K 50K 5000K

* Consult for more options

DIMENSIONS

All dimensions are inches. Specifications subject to change without notice.

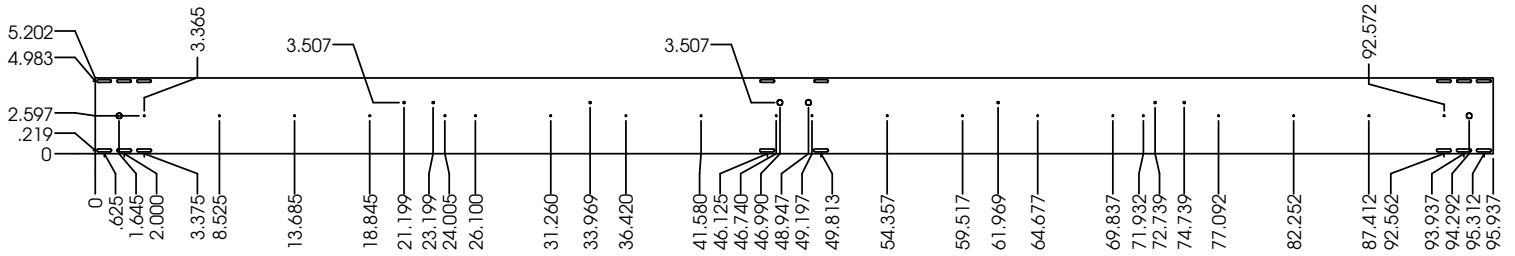
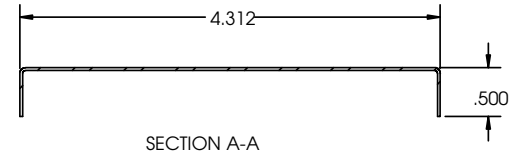
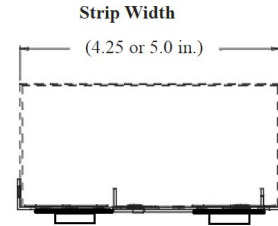
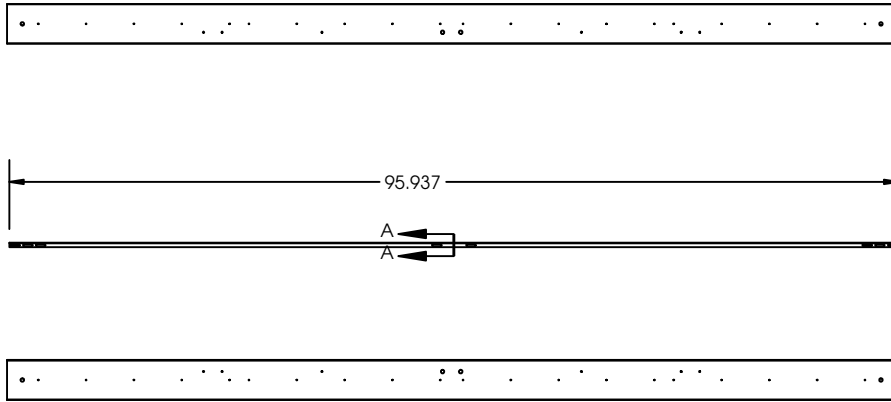

1 Row LED boards

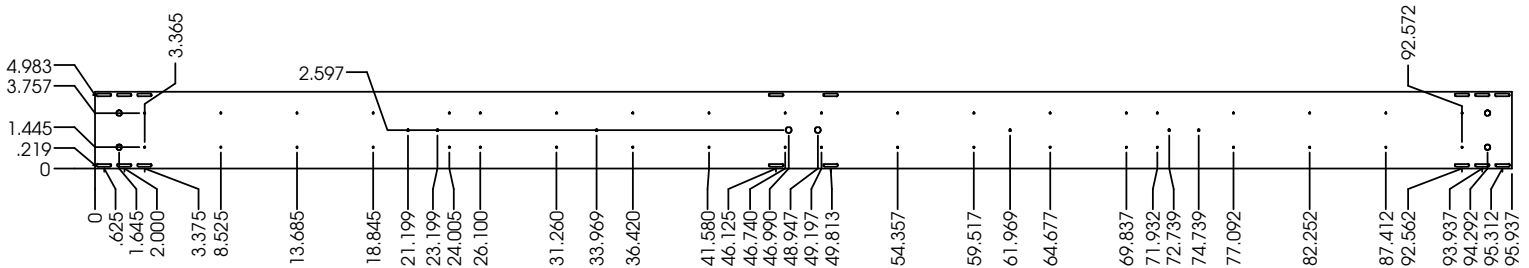

2 Rows LED boards