



Uphoria™ PRO LED MR16

LED MR16 with High Candela (90+ CRI)

Ushio America introduces new ENERGY STAR® certified 90+ CRI Uphoria™ PRO LED MR16 lamps. With the fit, form, and function of traditional MR16 lamps, these dimmable lamps have a unique optical design that delivers high candela. The COB design ensures excellent uniformity of light from the emitting surface. As such, Uphoria PRO LED MR16 lamps deliver crisper, cleaner shadows.

Available in 7W, these lamps provide up to 83% savings on energy costs. These LED MR16 lamps are damp location rated and UL 1993 rated for totally enclosed fixtures.

All Uphoria PRO LED MR16 lamps operate on 12V and are available in either a Warm White (2700K) or a Halogen White (3000K) color temperature. These are available in spot, narrow flood, and flood beam angles. Ushio America is proud to stand behind these ENERGY STAR® certified LED lamps with a 3-year limited warranty.



FEATURES & BENEFITS

- High Candela
- High Color Rendering (90+ CRI)
- COB for Crisper, Cleaner Shadows
- Smooth, Uniform Dimming
- Suitable for Use in Recessed Fixtures
- UL Rated for Totally Enclosed Fixtures (UL 1993)
- Direct Replacement for Traditional MR16 GU5.3 Lamps
- 25,000 Hours Rated Life
- Damp Location Rated
- Application Friendly: UV Free & IR Free
- Environmentally Friendly: Mercury Free, Lead Free and RoHS Compliant
- 3-Year Limited Warranty

APPLICATIONS

- Track Lighting
- Recessed Lighting
- Accent Lighting
- Art Gallery & Museum Lighting
- Hospitality Lighting

USHIO

SPECIFICATIONS

Case Quantity: 12

Watts (W)	Ordering Code	Lamp Description	Volts (V)	Color Temp (K)	Beam Angle	Lumens* (lm)	CBCP* (cd)	CRI	Rated** Life (h)
7	1004522	★ UPHORIA PRO LED MR16, SP15, SW27, 90+CRI	12	2700	15°	430	3410	90+	25,000
7	1004524	★ UPHORIA PRO LED MR16, SP15, WW30, 90+CRI	12	3000	15°	430	3422	90+	25,000
7	1004523	★ UPHORIA PRO LED MR16, NFL25, SW27, 90+CRI	12	2700	25°	430	2210	90+	25,000
7	1004436	★ UPHORIA PRO LED MR16, NFL25, WW30, 90+CRI	12	3000	25°	480	2225	90+	25,000
7	1004434	★ UPHORIA PRO LED MR16, FL40, SW27, 90+CRI	12	2700	40°	480	1064	90+	25,000
7	1004435	UPHORIA PRO LED MR16, FL40, WW30, 90+CRI	12	3000	40°	480	1193	90+	25,000

* Photometric data is based on LM-79 tests.

★ENERGY STAR® Certified

** Average life based on 70% lumen maintenance. LM-80 data available.

Electrical Specifications:

Driver: High Efficiency

Power Factor: > 0.9

Power Factor NFL > 0.8

CAUTIONS:

Suitable for dry and damp locations.

Suitable for use in recessed fixtures.

Suitable for use in totally enclosed fixtures (UL 1993).

Not for use in emergency or exit lighting.

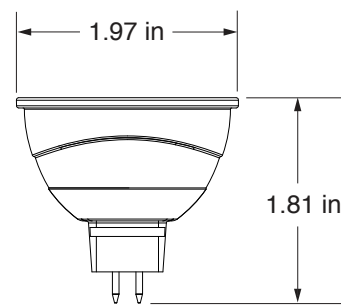

GU5.3 Base

PHOTOMETRICS & SPECTRAL DISTRIBUTION CHARTS

Photometrics

2700K

Item 1004522

θ (ft)	H(ft)	E(fc)
0.83	3.3	197.43
1.67	6.6	49.36
2.50	9.9	21.94
3.34	13.2	12.34
4.17	16.5	7.90
15°		7W
7W LED MR16, SP15, SW27		

Item 1004523

θ (ft)	H(ft)	E(fc)
1.24	3.3	210.19
2.47	6.6	52.55
3.71	9.9	23.35
4.94	13.2	13.14
6.18	16.5	8.41
25°		7W
7W LED MR16, NFL25, SW27		

Item 1004434

θ (ft)	H(ft)	E(fc)
2.10	3.3	98.00
4.20	6.6	24.52
6.30	9.9	10.90
8.40	13.2	6.13
10.52	16.5	3.92
40°		7W
7W LED MR16, FL40, SW27		

3000K

Item 1004524

θ (ft)	H(ft)	E(fc)
0.88	3.3	314.23
1.75	6.6	78.56
2.62	9.9	34.91
3.50	13.2	19.64
4.37	16.5	12.57
15°		7W
7W LED MR16, SP15, WW30		

Item 1004436

θ (ft)	H(ft)	E(fc)
1.24	3.3	204.32
2.47	6.6	51.08
3.71	9.9	22.70
4.94	13.2	12.77
6.18	16.5	8.17
25°		7W
7W LED MR16, NFL25, WW30		

Item 1004435

θ (ft)	H(ft)	E(fc)
2.10	3.3	109.55
4.10	6.6	27.39
6.20	9.9	12.17
8.20	13.2	6.85
10.30	16.5	4.38
40°		7W
7W LED MR16, FL40, WW30		

Spectral Distribution Charts

2700K

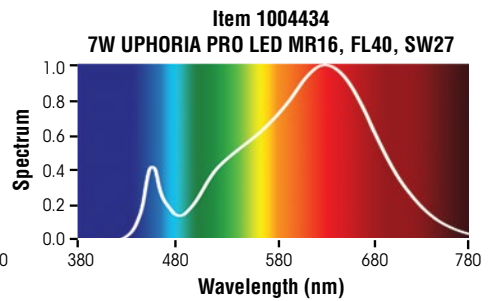
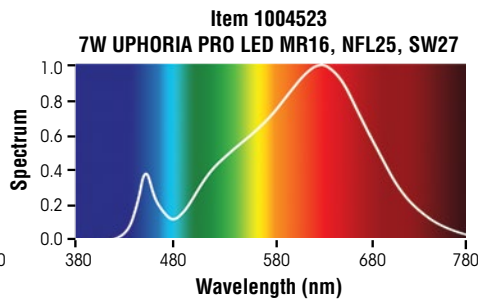
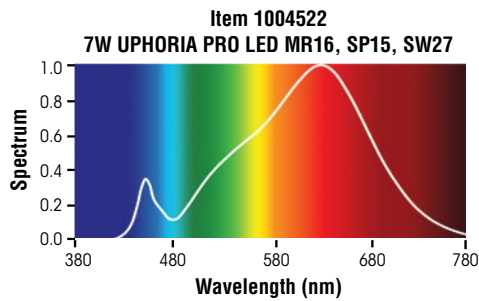

3000K

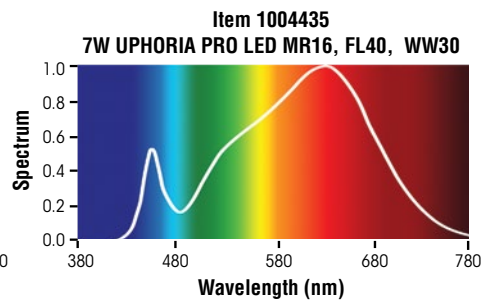
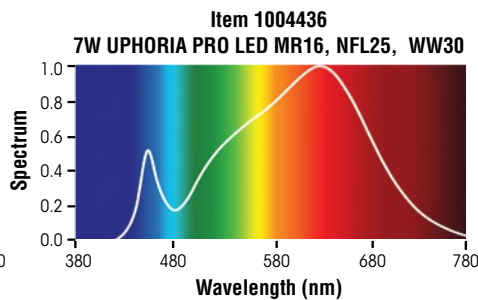
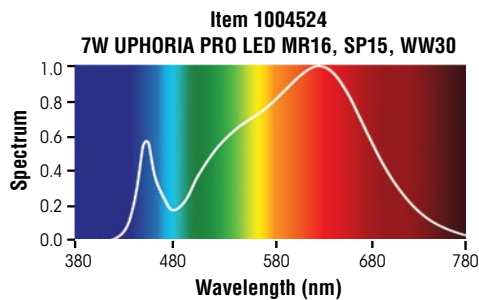

LIGHTING FACTS

2700K

Item 1004522
7W LED MR16, SP15, SW27

Lighting Facts/ Faits d'éclairage	
Per Bulb/Par l'ampoule	
Brightness/Luminosité	430 lumens
Estimated Yearly Energy Cost/ Coût énergétique annual estimé	\$0.84
Based on 3 hrs/day, 11¢/kWh. Cost depends on rates and use. /Basé sur 3 heures/jour, 11¢/kWh. Les coûts dépendent du tarif et de la fréquence d'utilisation.	
Life/Vie	22.8 years/ans
Based on 3 hrs/day. /Basé sur 3 heures/jour.	
Light Appearance/Apparence de l'éclairage	
Warm/Chaud	Cool/Froid
2700K	
Energy Used/Énergie utilisée	7 watts

Item 1004523
7W LED MR16, NFL25, SW27

Lighting Facts/ Faits d'éclairage	
Per Bulb/Par l'ampoule	
Brightness/Luminosité	430 lumens
Estimated Yearly Energy Cost/ Coût énergétique annual estimé	\$0.84
Based on 3 hrs/day, 11¢/kWh. Cost depends on rates and use. /Basé sur 3 heures/jour, 11¢/kWh. Les coûts dépendent du tarif et de la fréquence d'utilisation.	
Life/Vie	22.8 years/ans
Based on 3 hrs/day. /Basé sur 3 heures/jour.	
Light Appearance/Apparence de l'éclairage	
Warm/Chaud	Cool/Froid
2700K	
Energy Used/Énergie utilisée	7 watts

Item 1004434
7W LED MR16, FL40, SW27

Lighting Facts/ Faits d'éclairage	
Per Bulb/Par l'ampoule	
Brightness/Luminosité	480 lumens
Estimated Yearly Energy Cost/ Coût énergétique annual estimé	\$0.84
Based on 3 hrs/day, 11¢/kWh. Cost depends on rates and use. /Basé sur 3 heures/jour, 11¢/kWh. Les coûts dépendent du tarif et de la fréquence d'utilisation.	
Life/Vie	22.8 years/ans
Based on 3 hrs/day. /Basé sur 3 heures/jour.	
Light Appearance/Apparence de l'éclairage	
Warm/Chaud	Cool/Froid
2700K	
Energy Used/Énergie utilisée	7 watts

3000K

Item 1004524
7W LED MR16, SP15, WW30

Lighting Facts/ Faits d'éclairage	
Per Bulb/Par l'ampoule	
Brightness/Luminosité	430 lumens
Estimated Yearly Energy Cost/ Coût énergétique annual estimé	\$0.84
Based on 3 hrs/day, 11¢/kWh. Cost depends on rates and use. /Basé sur 3 heures/jour, 11¢/kWh. Les coûts dépendent du tarif et de la fréquence d'utilisation.	
Life/Vie	22.8 years/ans
Based on 3 hrs/day. /Basé sur 3 heures/jour.	
Light Appearance/Apparence de l'éclairage	
Warm/Chaud	Cool/Froid
3000K	
Energy Used/Énergie utilisée	7 watts

Item 1004436
7W LED MR16, NFL25, WW30

Lighting Facts/ Faits d'éclairage	
Per Bulb/Par l'ampoule	
Brightness/Luminosité	480 lumens
Estimated Yearly Energy Cost/ Coût énergétique annual estimé	\$0.84
Based on 3 hrs/day, 11¢/kWh. Cost depends on rates and use. /Basé sur 3 heures/jour, 11¢/kWh. Les coûts dépendent du tarif et de la fréquence d'utilisation.	
Life/Vie	22.8 years/ans
Based on 3 hrs/day. /Basé sur 3 heures/jour.	
Light Appearance/Apparence de l'éclairage	
Warm/Chaud	Cool/Froid
3000K	
Energy Used/Énergie utilisée	7 watts

Item 1004435
7W LED MR16, FL40, WW30

Lighting Facts/ Faits d'éclairage	
Per Bulb/Par l'ampoule	
Brightness/Luminosité	480 lumens
Estimated Yearly Energy Cost/ Coût énergétique annual estimé	\$0.84
Based on 3 hrs/day, 11¢/kWh. Cost depends on rates and use. /Basé sur 3 heures/jour, 11¢/kWh. Les coûts dépendent du tarif et de la fréquence d'utilisation.	
Life/Vie	22.8 years/ans
Based on 3 hrs/day. /Basé sur 3 heures/jour.	
Light Appearance/Apparence de l'éclairage	
Warm/Chaud	Cool/Froid
3000K	
Energy Used/Énergie utilisée	7 watts

CAUTION:

Lamp may not be compatible with all dimmers and transformers. Use only on 12V AC circuits. Do not open. No user serviceable parts inside. Suitable for damp locations. Suitable for use in recessed fixtures. Use is not recommended where exposed to weather. Outdoor usage requires an enclosed fixture. Meets UL 1993 safety rating for totally enclosed fixtures. Recommended lamp housing temperature is 150°F or below. Reliable operating environment temperature is -4°F to 113°F. Lamp is not intended for use with emergency exit fixtures, emergency exit lights, photo controls or electric timers. Lamp complies with Part 15 of the FCC Rules. Operation is subject to the following two conditions: (1) device may not cause harmful interference, and (2) device must accept any interference received, including interference that may cause undesired operation.