

# Recessed LED Panel

## DIMENSIONS

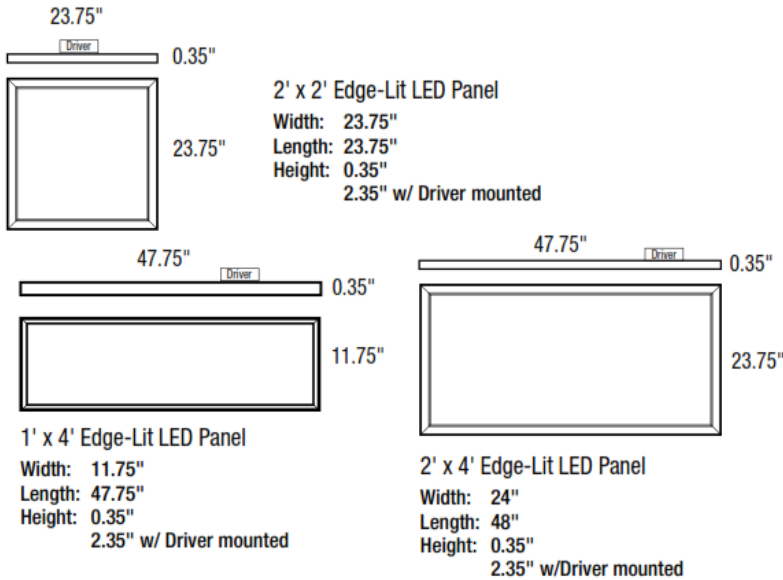

## APPLICATION

Typically used to replace traditional fluorescent lay in fixture. The RLP series is a next generation family of edge lite led flat panel fixtures designed to lay in drop ceilings in offices, schools, and healthcare application. The flat panels are fully dimmable, compatible with building controls, motion sensors, and daylight harvesting systems. The design of the RLP series panels produces an even and consistent shadow-less light. The LED's enable long life, high lumen maintenance, high CRI, low maintenance, and constructed without hazardous materials.

## FEATURES

- Equipped standard with a 0-10V continuous dimming driver that works with any standard 0-10V control/dimmer
- Fits Standard T-Bar and Narrow Grid Drop Ceiling
- Unique Optics Guide Plate Controls Glare and Provide Uniform Light Distribution
- Integrated Hard Lid Tie Points
- Low Profile Aluminum Housing, 2" Depth including transformer panel
- Long life, 60,000 hour LEDs at L80 reduce lift cycle maintenance costs
- Optional On/Off or Bi Level Motion Sensor, High voltage transformers, emergency battery backups, cords and whips

## QUICK SHIP

RLP-22-40-MVD-835	RLP-24-50-MVD-835
RLP-22-40-MVD-840	RLP-24-50-MVD-840
RLP-22-40-MVD-850	RLP-24-50-MVD-850

## CONSTRUCTION

Extruded aluminium housing with smooth opalescent acrylic lens.

## MOUNTING

Suitable for recessed mounting within T-Bar grid.

## ELECTRICAL

Equipped standard with 0-10V continuous dimming driver that works with any standard 0-10V control/dimmer. Long-Life LED's 60,000 hours at L80 with projected life over 100,000 hours for reduced life cycle maintenance costs.

## CERTIFICATION

All luminaires are built to UL 1598 and 2108 standards, and bear appropriate ETL labels. Damp location labeling is standard. Emergency equipped fixtures labeled UL924. Adheres to LM70, LM80, and TM21 industry standards. Design Lights Consortium (DLC) qualified product. Not all models of this product maybe DLC qualified.

## WARRANTY

5-year limited warranty. See complete warranty for terms and exclusions. (Labor not included).

## ORDERING INFORMATION

Example Model Number: RLP-22-40-MVD-840-MOS

RLP					
SERIES	FORM FACTOR	RATED WATTAGE	DRIVER TYPE	CRI AND KELVIN	OPTIONS
	14- 1'x4' Housing <sup>1</sup> 22- 2'x2' Housing <sup>2</sup> 24- 2'x4' Housing <sup>3</sup>	1x4 and 2x2 Housing 40- 40W (4413 Lumens) <sup>3</sup> 2x4 Housing 50- 50W (5861 Lumens) <sup>3</sup>	MVD- 120-277V; 0-10V Dimming <sup>3</sup>	835 - 80 CRI; 3500 Kelvin <sup>1 3</sup> 840 - 80 CRI; 4000 Kelvin <sup>3</sup> 850 - 80 CRI; 5000 Kelvin <sup>1 3</sup>	MOS- Integrated Microwave Sensor, On/Off FW3- 6', 3 Wire Fixture Whip FW4- 6', 4 Wire Fixture Whip EML8- Emergency Battery Pack, 800 Lumens EML16- Emergency Battery Pack, 1400 Lumens MOSB- Integrated Bi Level Microwave sensor

Notes:

<sup>1</sup>Made to order items. Minimum 90 day lead time. Minimum 500 order quantity.

<sup>2</sup>DLC Listed

<sup>3</sup>DLC Premium Listed

<sup>4</sup>Quick ship: XK. Other CCTs may require lead time or special orders.

<sup>5</sup>Typical color consistency may vary or be changed