

DESCRIPTION

The SkyRidge™ transforms ambient lighting by perfectly blending a refined modern styling with our breakthrough WaveStream™ LED technology to deliver exceptional performance and superior energy savings. SkyRidge's advanced engineered LED system with superior optical design delivers an unparalleled combination of optimal light uniformity and exceptional efficiency for greater energy savings.

SkyRidge is compatible with all of today's popular ceiling systems and available in a variety of configurations for application versatility. Its perfect balance of form and function make it an ideal choice for commercial office spaces, schools, hospitals, retail and other indoor ambient applications.

SPECIFICATION FEATURES

Construction

Shallow 4.75" deep housing is extruded aluminum frame and injected molded composite end plates. End plates are securely attached with screws for strength and rigidity and the elimination of gaps. End plates have accessory grid-lock feature for safety and convenience. Four auxiliary fixture end suspension points are provided. Large access plate for supply connection.

Controls

The SkyRidge LED is Powered by Fifth Light, with a standard 0-10V continuous dimming driver that works with any 0-10V control/dimmer. Combine with energy saving products like occupancy sensors, daylighting controls and lighting relay panels to maximize energy savings. In addition, the SkyRidge can include a factory-installed integrated sensor system for occupancy and daylight dimming control and manual control from an optional handheld remote. Or, specify the Digital Addressable Lighting Interface (DALI) drivers, dimmable down to 1% with the HD option, for use with Fifth Light controls. See ordering information for details on all three options.

Electrical

Long-life LED system coupled with electrical driver to deliver optimal performance. LED's available in 3000K, 3500K, 4000K or 5000K with a typical CRI ≥ 85. Projected life is 100,000 hours at 92% lumen output. Electronic drivers are available for 120-277V applications.

Emergency Battery Pack Option

Optional 120v-277v integral emergency battery pack is available in 7-watts or 14-watts to meet critical life-safety lighting requirements. The 90-minute batteries provide constant power to the LED system, ensuring code-compliance. A test switch/indicator button can be tested safely from the ground using a laser pointer, while the patented EZ Key prevents accidental discharge of the battery during construction. See ordering information for details.

Driver Access

Drivers can be accessed via plenum.

Finish

Durable frame has high reflectance baked matte white enamel finish for luminous uniformity.

Optics

Precision formed optical assembly with positively retained high optical grade acrylic lens provides a directed optical distribution using WaveStream LED technology.

SkyTrim Accessory

Designed for an array of interior applications, SkyTrim is a luminous decorative accent that can be mounted directly on the light guide of a SkyRidge fixture either at the factory or in the field. It is ideal for spaces where color is necessary to provide visual cues, emphasize brand identity, directional awareness or simply as an artistic expression.

Compliance

Components are UL recognized. Indoor luminaires are cULus listed for 25° C ambient environments, RoHS compliant, and comply with IESNA LM-79. LEDs comply with LM-80 standards.

Warranty

Five year warranty.



**24SR
LED**

**2' X 4' TROFFER
LED MODULE**

Specification Grade Troffer



CURVED

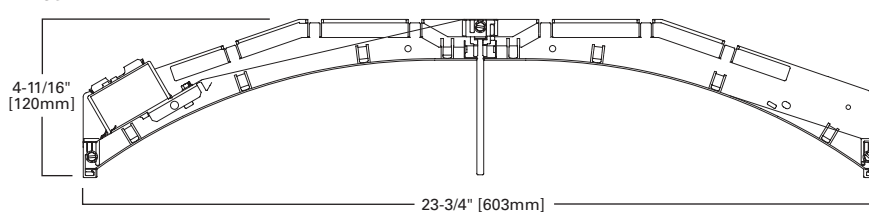

MOUNTING DATA

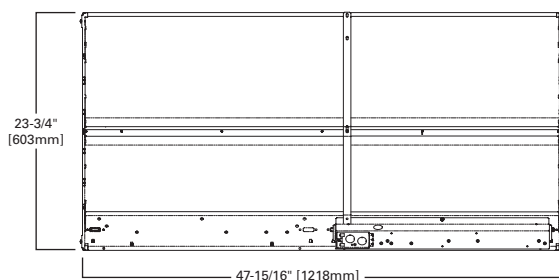

LAMP CONFIGURATIONS

CURVED

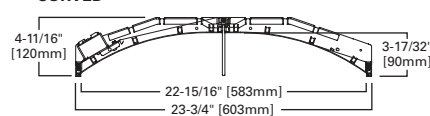

STRAIGHT

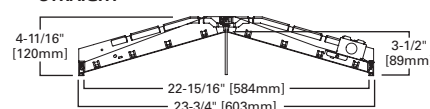

*See Drywall Frame Kit Accessory in Ordering Information section.

**Fixture construction is suitable for use in Air-handling and plenum rated spaces in accordance with Section 300.22 (C) of the National Electrical Code, Section 4.3.11.2.6.5 of NFPA 90A and Section 602.2.1.4 of ICC.

LINEAR DISCONNECT

Safe and convenient means of disconnecting power



CEILING COMPATIBILITY

G
Grid/Lay-in
Standard

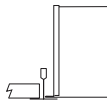

F
Drywall Frame
Kit

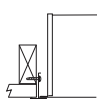

Ceiling Type
Trim Type

Exposed Grid
Concealed T
Slot Grid
Flange

G
G or T
G or T
*

PHOTOMETRICS

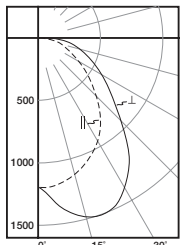

24SR-LD2-39-C-UNV-L835-CD1-U

Electronic Driver
Linear LED 3500K
Spacing criterion:
(II) 1.2 x mounting
height, (⊥) 1.5 x
mounting height
Lumens: 3997
Input Watts: 31.9W
Efficacy: 125.3 lm/W
Test Report:
24SR-LD2-39-C-UNV-
L835-CD1-U.IES

Candlepower

Angle	Along II	45°	Across ⊥
0	1187	1187	1187
5	1186	1248	1301
10	1165	1330	1417
15	1130	1376	1479
20	1080	1382	1494
25	1019	1350	1462
30	939	1282	1375
35	847	1182	1247
40	746	1059	1096
45	639	931	939
50	533	811	794
55	439	701	667
60	351	607	567
65	279	523	478
70	213	443	404
75	157	365	331
80	105	279	234
85	56	162	130
90	0	0	0

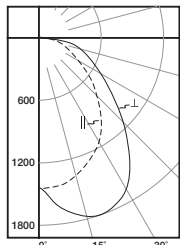

24SR-LD2-48-C-UNV-L835-CD1-U

Electronic Driver
Linear LED 3500K
Spacing criterion:
(II) 1.2 x mounting
height, (⊥) 1.5 x
mounting height
Lumens: 4805
Input Watts: 38.2W
Efficacy: 125.8 lm/W
Test Report:
24SR-LD2-48-C-UNV-
L835-CD1-U.IES

Candlepower

Angle	Along II	45°	Across ⊥
0	1437	1437	1437
5	1438	1502	1565
10	1412	1599	1696
15	1370	1651	1774
20	1308	1660	1794
25	1231	1621	1757
30	1136	1538	1654
35	1030	1421	1506
40	905	1274	1320
45	774	1122	1127
50	647	972	952
55	529	844	801
60	425	727	676
65	334	627	573
70	256	530	483
75	186	437	397
80	125	335	282
85	65	194	153
90	0	0	0

Coefficients of Utilization

rc rw RCR	Effective floor cavity reflectance																							
	80%				70%				50%				30%				10%				0%			
	70	50	30	10	70	50	30	10	50	30	10	50	30	10	50	30	10	50	30	10	50	30	10	0
0	119	119	119	119	116	116	116	116	111	111	111	106	106	106	102	102	102	100	100	100	100	100	100	100
1	108	103	98	94	105	101	96	93	96	93	90	92	89	87	89	86	84	82	82	82	82	82	82	82
2	98	89	82	76	95	87	81	75	84	78	74	81	76	72	78	74	70	68	68	68	68	68	68	68
3	89	78	70	63	87	77	69	63	74	67	62	71	65	61	68	64	60	57	57	57	57	57	57	57
4	82	70	61	54	79	68	60	53	66	58	53	63	57	52	61	56	51	49	49	49	49	49	49	49
5	75	62	53	46	73	61	53	46	59	51	46	57	50	45	55	49	45	42	42	42	42	42	42	42
6	70	56	47	41	68	55	47	40	53	46	40	52	45	40	50	44	39	37	37	37	37	37	37	37
7	65	51	42	36	63	50	42	36	49	41	35	47	40	35	46	40	35	33	33	33	33	33	33	33
8	60	47	38	32	59	46	38	32	44	37	32	43	36	32	42	36	31	29	29	29	29	29	29	29
9	56	43	34	29	55	42	34	29	41	34	29	40	33	28	39	33	28	26	26	26	26	26	26	26
10	53	39	31	26	51	39	31	26	38	31	26	37	30	26	36	30	26	24	24	24	24	24	24	24

Zonal Lumen Summary

Zone	Lumens	% Fixture
0-30	1105	27.6
0-40	1810	45.3
0-60	3060	76.6
0-90	3997	100.0
0-180	3997	100.0

Coefficients of Utilization

rc rw RCR	Effective floor cavity reflectance																							
	80%				70%				50%				30%				10%				0%			
	70	50	30	10	70	50	30	10	50	30	10	50	30	10	50	30	10	50	30	10	50	30	10	0
0	119	119	119	119	116	116	116	116	111	111	111	106	106	106	102	102	102	100	100	100	100	100	100	100
1	108	103	98	94	105	101	96	93	96	93	90	92	89	87	89	86	84	82	82	82	82	82	82	82
2	98	89	82	76	95	88	81	75	84	78	74	81	76	72	78	74	70	68	68	68	68	68	68	68
3	89	78	70	63	87	77	69	63	74	67	62	71	65	61	68	64	60	57	57	57	57	57	57	57
4	82	70	61	54	79	68	60	53	66	58	53	63	57	52	61	56	51	49	49	49	49	49	49	49
5	75	62	53	46	73	61	53	46	59	51	46	57	50	45	55	49	45	42	42	42	42	42	42	42
6	70	56	47	41	68	55	47	40	53	46	40	52	45	40	50	44	39	37	37	37	37	37	37	37
7	65	51	42	36	63	50	42	36	49	41	35	47	40	35	46	40	35	33	33	33	33	33	33	33
8	60	47	38	32	59	46	38	32	44	37	32	43	36	32	42	36	31	29	29	29	29	29	29	29
9	56	43	34	29	55	42	34	29	41	34	29	40	33	28	39	33	28	26	26	26	26	26	26	26
10	53	39	31	26	51	39	31	26	38	31	26	37	30	26	36	30	26	24	24	24	24	24	24	24

Zonal Lumen Summary

Zone	Lumens	% Fixture
0-30	1328	27.6
0-40	2177	45.3
0-60	3680	76.6
0-90	4805	100.0
0-180	4805	100.0

ENERGY AND PERFORMANCE DATA BY CATALOG NUMBER

Stock or MTO*	Catalog Logic (Curved)	Delivered Lumens	Watts	Efficacy (LPW)
MTO	24SR-LD2-29-C-UNV-L830-CD1-U	2840	22.7	125
MTO	24SR-LD2-29-C-UNV-L835-CD1-U	2928	22.7	129
MTO	24SR-LD2-29-C-UNV-L840-CD1-U	2987	22.7	132
MTO	24SR-LD2-29-C-UNV-L850-CD1-U	3250	22.7	143
MTO	24SR-LD2-34-C-UNV-L830-CD1-U	3360	27.2	124
MTO	24SR-LD2-34-C-UNV-L835-CD1-U	3464	27.2	127
MTO	24SR-LD2-34-C-UNV-L840-CD1-U	3533	27.2	130
MTO	24SR-LD2-34-C-UNV-L850-CD1-U	3845	27.2	141
MTO	24SR-LD2-39-C-UNV-L830-CD1-U	3877	31.9	122
Stock	24SR-LD2-39-C-UNV-L835-CD1-U	3997	31.9	125
Stock	24SR-LD2-39-C-UNV-L840-CD1-U	4077	31.9	128
MTO	24SR-LD2-39-C-UNV-L850-CD1-U	4437	31.9	139
MTO	24SR-LD2-45-C-UNV-L830-CD1-U	4377	36.7	119
MTO	24SR-LD2-45-C-UNV-L835-CD1-U	4512	36.7	123
MTO	24SR-LD2-45-C-UNV-L840-CD1-U	4602	36.7	125
MTO	24SR-LD2-45-C-UNV-L850-CD1-U	5008	36.7	136
MTO	24SR-LD2-48-C-UNV-L830-CD1-U	4661	38.2	122
Stock	24SR-LD2-48-C-UNV-L835-CD1-U	4805	38.2	126
Stock	24SR-LD2-48-C-UNV-L840-CD1-U	4901	38.2	128
MTO	24SR-LD2-48-C-UNV-L850-CD1-U	5334	38.2	140
MTO	24SR-LD2-53-C-UNV-L830-CD1-U	5158	43.1	120
MTO	24SR-LD2-53-C-UNV-L835-CD1-U	5318	43.1	123
MTO	24SR-LD2-53-C-UNV-L840-CD1-U	5424	43.1	126
MTO	24SR-LD2-53-C-UNV-L850-CD1-U	5903	43.1	137
MTO	24SR-LD2-59-C-UNV-L830-CD1-U	5739	50.2	114
MTO	24SR-LD2-59-C-UNV-L835-CD1-U	5917	50.2	118
MTO	24SR-LD2-59-C-UNV-L840-CD1-U	6035	50.2	120
MTO	24SR-LD2-59-C-UNV-L850-CD1-U	6568	50.2	131
MTO	24SR-LD2-64-C-UNV-L830-CD1-U	6284	55.5	113
MTO	24SR-LD2-64-C-UNV-L835-CD1-U	6478	55.5	117
MTO	24SR-LD2-64-C-UNV-L840-CD1-U	6608	55.5	119
MTO	24SR-LD2-64-C-UNV-L850-CD1-U	7191	55.5	130

*Made to order (MTO) requires a typical two week lead time.

ENERGY AND PERFORMANCE DATA BY CATALOG NUMBER

Stock or MTO*	Catalog Logic (Straight)	Delivered Lumens	Watts	Efficacy (LPW)
MTO	24SR-LD2-29-S-UNV-L830-CD1-U	2811	22.7	124
MTO	24SR-LD2-29-S-UNV-L835-CD1-U	2898	22.7	128
MTO	24SR-LD2-29-S-UNV-L840-CD1-U	2956	22.7	130
MTO	24SR-LD2-29-S-UNV-L850-CD1-U	3216	22.7	142
MTO	24SR-LD2-34-S-UNV-L830-CD1-U	3325	27.2	122
MTO	24SR-LD2-34-S-UNV-L835-CD1-U	3428	27.2	126
MTO	24SR-LD2-34-S-UNV-L840-CD1-U	3497	27.2	129
MTO	24SR-LD2-34-S-UNV-L850-CD1-U	3805	27.2	140
MTO	24SR-LD2-39-S-UNV-L830-CD1-U	3837	31.9	120
MTO	24SR-LD2-39-S-UNV-L835-CD1-U	3956	31.9	124
MTO	24SR-LD2-39-S-UNV-L840-CD1-U	4035	31.9	127
MTO	24SR-LD2-39-S-UNV-L850-CD1-U	4391	31.9	138
MTO	24SR-LD2-45-S-UNV-L830-CD1-U	4331	36.7	118
MTO	24SR-LD2-45-S-UNV-L835-CD1-U	4465	36.7	122
MTO	24SR-LD2-45-S-UNV-L840-CD1-U	4555	36.7	124
MTO	24SR-LD2-45-S-UNV-L850-CD1-U	4957	36.7	135
MTO	24SR-LD2-48-S-UNV-L830-CD1-U	4613	38.2	121
MTO	24SR-LD2-48-S-UNV-L835-CD1-U	4755	38.2	125
MTO	24SR-LD2-48-S-UNV-L840-CD1-U	4850	38.2	127
MTO	24SR-LD2-48-S-UNV-L850-CD1-U	5278	38.2	138
MTO	24SR-LD2-53-S-UNV-L830-CD1-U	5105	43.1	118
MTO	24SR-LD2-53-S-UNV-L835-CD1-U	5263	43.1	122
MTO	24SR-LD2-53-S-UNV-L840-CD1-U	5368	43.1	125
MTO	24SR-LD2-53-S-UNV-L850-CD1-U	5842	43.1	136
MTO	24SR-LD2-59-S-UNV-L830-CD1-U	5680	50.2	113
MTO	24SR-LD2-59-S-UNV-L835-CD1-U	5856	50.2	117
MTO	24SR-LD2-59-S-UNV-L840-CD1-U	5973	50.2	119
MTO	24SR-LD2-59-S-UNV-L850-CD1-U	6500	50.2	130
MTO	24SR-LD2-64-S-UNV-L830-CD1-U	6219	55.5	112
MTO	24SR-LD2-64-S-UNV-L835-CD1-U	6411	55.5	116
MTO	24SR-LD2-64-S-UNV-L840-CD1-U	6539	55.5	118
MTO	24SR-LD2-64-S-UNV-L850-CD1-U	7116	55.5	128

*Made to order (MTO) requires a typical two week lead time.

LUMEN MAINTENANCE

Ambient Temperature	TM-21 Lumen Maintenance (100,000 hours)	Theoretical L70 (Hours)
25°C	> 92%	> 448,000

Non-IC data

SKYTRIM FIELD INSTALLATION KITS

Color Choice	Kit Catalog Number	Kit Quantity
Tahitian Blue	STK-4-TB-10PK	10
Primary Green	STK-4-PG-10PK	10
Storaro Orange	STK-4-SO-10PK	10
Belladonna Rose	STK-4-BR-10PK	10
Medium Red	STK-4-MR-10PK	10
Pearl	STK-4-PL-10PK	10
Straw	STK-4-ST-10PK	10
Custom Color	STK-4-CC-*-10PK	10

*Custom color requires Roscolux numeric specification color code, consult factory for more information.

Note: Chosen color will be matched on acrylic but will appear lighter once applied to lit light guide.

ORDERING INFORMATION

SAMPLE NUMBER: 24SR-LD2-48-C-UNV-L835-CD1-SVDP1-U

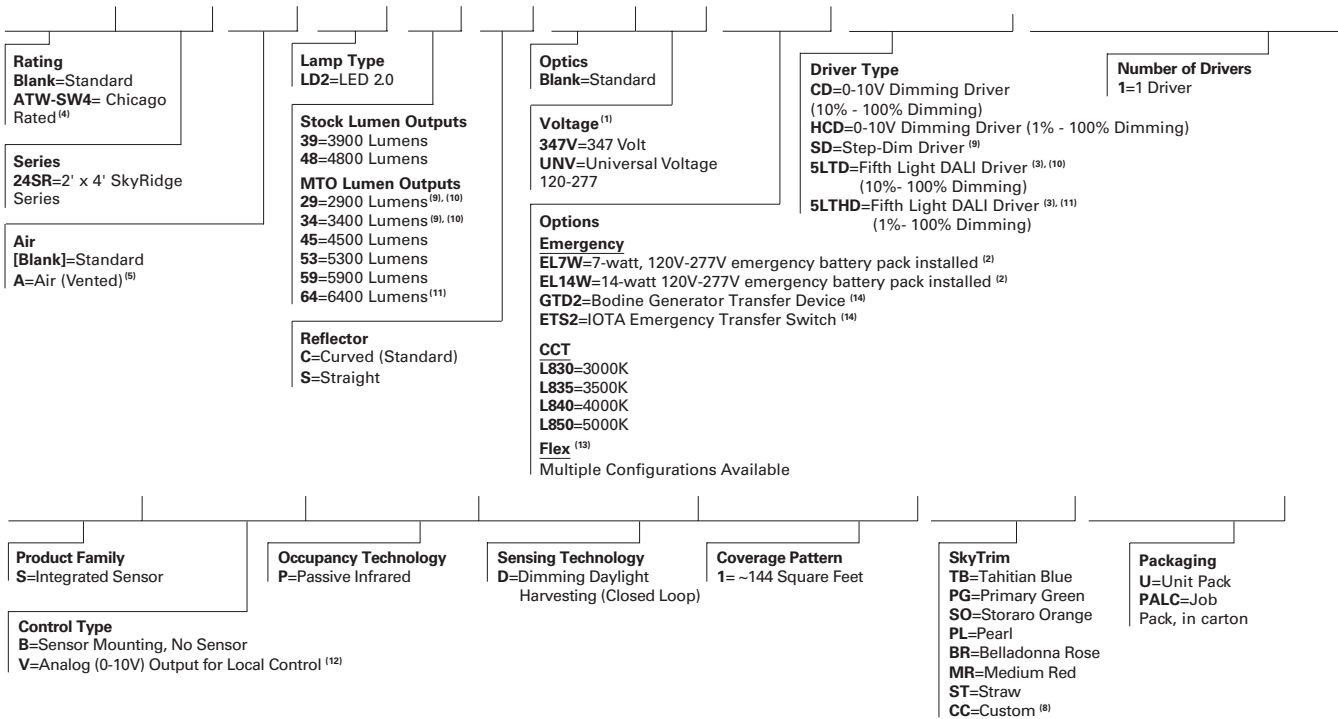

ACCESSORIES

- T3A END E.Q. BRACKET PARTS BAG (Standard with fixture)
- DF-24-W=2' x 4' Drywall Frame Kit
- SK-24-WT=2' x 4' Tall Surface Mount Kit
- DF10P-C_=Decorator Dimmer, 0-10V
- SF10P-_=Decorator Slide Dimmer, 0-10V
- ISHH-01=Programming Remote for Integrated Sensor
- ISHH-02=Personal Control Remote for Integrated Sensor

NOTES: ⁽¹⁾Products also available in non-US voltages and frequencies for international markets. ⁽²⁾With integral test switch/indicator/laser test. For approximate delivered lumens multiply the lumens per watt of the desired fixture by the wattage of the emergency battery pack (100 lm/W x 7=700 lumens). IES-format photometry for luminaire under emergency operation available. ⁽³⁾Must be used in conjunction with a DALI control system. ⁽⁴⁾Chicago rated version does not allow for row mounting. ⁽⁵⁾Air version is vented but does not meet air handling requirements. Air version is non-IC. Air version is not available with integrated sensor. ⁽⁶⁾Custom color must list Roscolux numeric color specification code. ⁽⁹⁾2900 and 3400 lumen packages are not available with Step-Dim driver. ⁽¹⁰⁾5LTD option is not available in 2900 and 3400 lumen packages. ⁽¹¹⁾5LTHD option uses two drivers at 6400 lumens. ⁽¹²⁾Integral sensor works only with "CD" driver and is factory prewired to the driver for stand-alone control. ⁽¹³⁾Flex does not include dimming leads. Control leads provided by others. ⁽¹⁴⁾Used to transfer fixture to secondary power source for life-safety operation. When used with a dimming fixture, two devices are required to ensure control is disabled while operating under emergency power.

Specifications & dimensions subject to change without notice. Consult your Eaton Representative for availability and ordering information.

SHIPPING DATA

Catalog No.	Wt.
24SR-LD2-39	24 lbs.
24SR-LD2-48	24 lbs.

INTEGRATED SENSOR

The SkyRidge with Integrated Sensor technology provides automatic energy savings without sacrificing performance. Traditionally, these types of energy savings required coordination between the luminaire and a lighting control system. The SkyRidge delivers superior lighting with integrated occupancy and daylighting controls.

Capture the benefits of traditional lighting controls, without complicated coverage planning or special wiring. Ideal for new construction or retrofit, the SkyRidge delivers automatic ON to an energy saving light level, while ensuring lighting is turned OFF when the space is unoccupied.

The integral daylight sensor reduces the need for special daylight zone planning. Each luminaire will automatically adjust the light level based on reflected light beneath the sensor in a closed loop method.

Occupied daylight light levels and unoccupied light levels can be adjusted using the integrated sensor programming remote (Catalog Number: ISHH-01). The integrated sensor personal remote (Catalog Number: ISHH-02) provides code compliant manual raise, lower, ON, OFF control.

The SkyRidge with Integrated Sensor is easy to install with no special wiring and ensures energy savings out-of-the-box with default control settings.

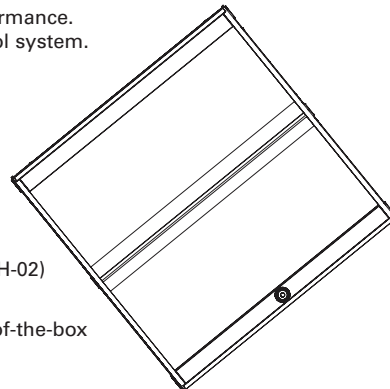

How it works:

- As the user enters the space controlled by the integral sensor, the lighting turns ON to the default daylight level.
- Lighting will remain at that the daylight level until the space is unoccupied. This will start the occupancy timeout period (default 20 minutes).
- If the space remains unoccupied for half of the timeout period, the lighting will automatically reduce to the Energy Saver light level. This adjustable light level is typically half of the occupied daylight level.
- At the end of the timeout period the lighting will go to the unoccupied light level. This adjustable light level uses the OFF default setting.

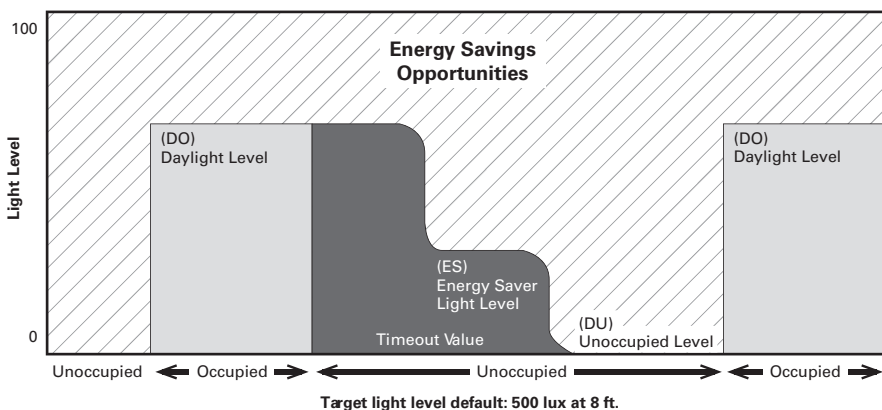

Coverage

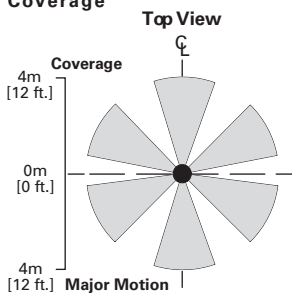

Side View

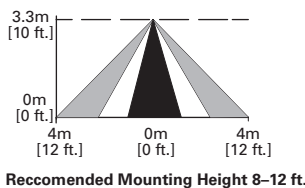

Optional Remote Controls



ISHH-01 Programming Remote



ISHH-02 Personal Control Remote