

**DESCRIPTION**

The Encounter™ redefines ambient lighting by being the first fixture to blend modern contemporary styling with the innovative WaveStream™ technology to deliver exceptional performance and superior energy savings. Encounter's highly efficient LED system with advance optical design delivers an unparalleled combination of optimal light uniformity for enhanced visual comfort and superior efficiency for greater energy savings.

Encounter is compatible with all of today's popular ceiling systems and available in a variety of configurations for application versatility. Its perfect balance of form and function make it an ideal choice for commercial office spaces, schools, hospitals, retail and other indoor ambient applications.

**SPECIFICATION FEATURES**

**Construction**

Shallow 3-1/4" deep housing is extruded aluminum frame and injected molded composite end plates. End plates are securely attached with screws for strength and rigidity and the elimination of gaps. End plates have accessory grid-lock feature for safety and convenience. Four auxiliary fixture end suspension points are provided. Large access plate for supply connection.

**Controls**

The Encounter LED is Powered by Fifth Light, with a standard 0-10V continuous dimming driver that works with any 0-10V control/dimmer. Combine with energy saving products like occupancy sensors, daylighting controls and lighting relay panels to maximize energy savings. In addition, the Encounter can include a factory-installed integrated sensor system for occupancy and daylight dimming control and manual control from an optional handheld remote. Or, specify the Digital Addressable Lighting Interface (DALI) drivers, dimmable down to 1% with the HD option, for use with Fifth Light controls. See ordering information for details on all three options.

**Electrical**

Long-life LED system coupled with electrical driver to deliver optimal performance. LED's available in 3000K, 3500K, 4000K or 5000K with a typical CRI ≤ 85. Projected life is 100,000 hours at 92% lumen output. Electronic drivers are available for 120-277V applications.

**Emergency Battery Pack Option**

Optional 120v-277v integral emergency battery pack is available in 7-watts or 14-watts to meet critical life-safety lighting requirements. The 90-minute batteries provide constant power to the LED system, ensuring code-compliance. A test switch/indicator button can be tested safely from the ground using a laser pointer, while the patented EZ Key prevents accidental discharge of the battery during construction. See ordering information for details.

**Driver Access**

Drivers can be accessed via plenum.

**Finish**

Durable frame has high reflectance baked matte white enamel finish for luminous uniformity.

**Optics**

Precision formed optical assembly with positively retained high optical grade acrylic lenses provide a directed optical distribution using WaveStream technology.

**Compliance**

Components are UL recognized. Indoor luminaires are cULus and CSA listed for 25° C ambient environments, RoHS compliant, and comply with IESNA LM-79. LEDs comply with LM-80 standards.

**Warranty**

Five year warranty.



**22EN  
LED**

**2' X 2' TROFFER  
LED MODULE**

Specification Grade Troffer



powered by  
**fifthlight**  
technology

**CERTIFICATION DATA**

cULus - 1598 and 2043\*\*  
Damp Location Listed  
CSA  
IC Rated  
LM79/LM80 Compliant  
ROHS Compliant  
NOM Compliant

\*See Drywall Frame Kit Accessory in Ordering Information section.

\*\*Fixture construction is suitable for use in Air-handling and plenum rated spaces in accordance with Section 300.22 (C) of the National Electrical Code, Section 4.3.11.2.6.5 of NFPA 90A and Section 602.2.1.4 of ICC.

**LINEAR DISCONNECT**

Safe and convenient means of disconnecting power



PS519064EN  
2016-02-12 13:12:20

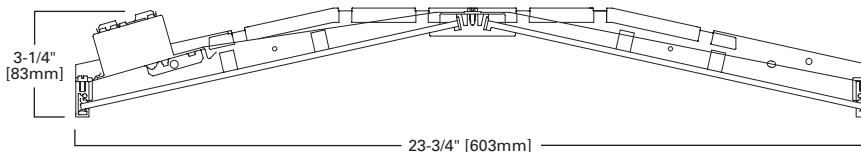

**MOUNTING DATA**

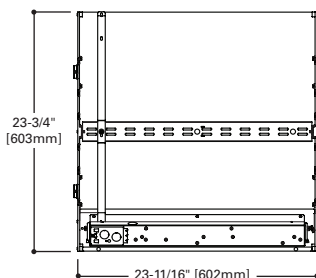

**LAMP CONFIGURATIONS**

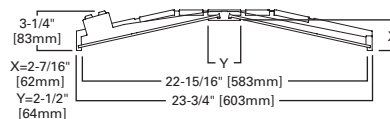

**CEILING COMPATIBILITY**

**G**  
Grid/Lay-in  
Standard

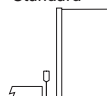

**F**  
Drywall Frame  
Kit



**Ceiling  
Type**

Exposed Grid  
Concealed T  
Slot Grid  
Flange

**Trim  
Type**

G  
G or T  
G or T  
\*

PHOTOMETRICS

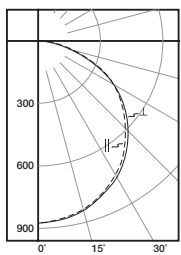

**22EN-LD2-25-UNV-L835-CD1-U**

Electronic Driver  
 Linear LED 3500K  
 Spacing criterion:  
 (II) 1.3 x mounting  
 height, ( ) 1.3 x  
 mounting height  
 Lumens: 2571  
 Input Watts: 20.9W  
 Efficacy: 122.5 lm/W  
 Test Report:  
 22EN-LD2-25-UNV-  
 L835-CD1-U.IES

Candlepower				
Angle	Along II	45°	Across	
0	873	873	873	
5	869	868	871	
10	856	856	861	
15	837	837	844	
20	811	811	819	
25	780	779	790	
30	741	741	753	
35	700	698	711	
40	650	649	662	
45	598	595	608	
50	539	535	549	
55	474	472	486	
60	405	402	421	
65	335	328	348	
70	259	255	257	
75	185	178	157	
80	111	97	103	
85	41	43	43	
90	0	0	0	

Coefficients of Utilization

rc rw RCR	Effective floor cavity reflectance 20%																							
	80%				70%				50%				30%				10%				0%			
	70	50	30	10	70	50	30	10	50	30	10	50	30	10	50	30	10	50	30	10	50	30	10	0
0	119	119	119	119	116	116	116	116	111	111	111	111	106	106	106	106	102	102	102	100	100	100	100	100
1	109	104	99	95	106	101	97	94	97	94	91	93	91	88	90	87	85	83	83	83	83	83	83	83
2	99	90	83	77	96	88	82	76	85	79	75	81	77	73	78	75	71	69	69	69	69	69	69	69
3	90	79	71	64	87	77	70	63	74	68	62	72	66	61	69	64	60	58	58	58	58	58	58	58
4	82	70	61	54	80	68	60	54	66	59	53	64	57	52	61	56	51	49	49	49	49	49	49	49
5	75	62	53	46	73	61	52	46	59	51	46	57	50	45	55	49	45	42	42	42	42	42	42	42
6	69	56	47	40	68	55	46	40	53	45	40	51	45	39	50	44	39	37	37	37	37	37	37	37
7	64	51	42	36	63	50	41	35	48	41	35	47	40	35	45	39	35	33	33	33	33	33	33	33
8	60	46	38	32	58	45	37	32	44	37	31	43	36	31	42	36	31	29	29	29	29	29	29	29
9	56	42	34	28	54	42	34	28	41	33	28	39	33	28	38	32	28	26	26	26	26	26	26	26
10	52	39	31	26	51	39	31	26	38	30	26	37	30	26	36	30	25	24	24	24	24	24	24	24

Zonal Lumen Summary

Zone	Lumens	% Fixture
0-30	680	26.4
0-40	1118	43.5
0-60	2005	78.0
0-90	2571	100.0
0-180	2571	100.0

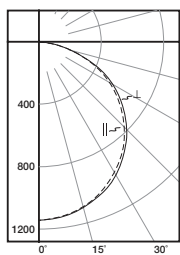

**22EN-LD2-34-UNV-L835-CD1-U**

Electronic Driver  
 Linear LED 3500K  
 Spacing criterion:  
 (II) 1.3 x mounting  
 height, (L) 1.3 x  
 mounting height  
 Lumens: 3370  
 Input Watts: 28.5W  
 Efficacy: 118.2 lm/W  
 Test Report:  
 22EN-LD2-34-UNV-  
 L835-CD1-U.IES

Candlepower				
Angle	Along II	45°	Across	⊥
0	1142	1142	1142	
5	1137	1136	1141	
10	1121	1120	1127	
15	1098	1097	1106	
20	1064	1064	1075	
25	1023	1023	1037	
30	974	971	988	
35	918	917	933	
40	854	852	869	
45	784	780	800	
50	708	702	722	
55	624	618	638	
60	534	526	553	
65	440	431	457	
70	339	334	340	
75	241	232	205	
80	145	126	135	
85	54	56	58	
90	0	0	0	

Coefficients of Utilization

rc rw RCR	Effective floor cavity reflectance 20%																							
	80%				70%				50%				30%				10%				0%			
	70	50	30	10	70	50	30	10	50	30	10	50	30	10	50	30	10	50	30	10	50	30	10	0
0	119	119	119	119	116	116	116	116	111	111	111	111	106	106	106	106	102	102	102	100	100	100	100	100
1	109	104	99	95	106	101	97	94	97	94	91	93	91	88	90	87	85	83	83	83	83	83	83	83
2	99	90	83	77	96	88	82	76	85	79	75	81	77	73	78	75	71	69	69	69	69	69	69	69
3	90	79	71	64	87	77	70	63	74	68	62	72	66	61	69	64	60	58	58	58	58	58	58	58
4	82	70	61	54	80	68	60	54	66	59	53	64	57	52	61	56	51	49	49	49	49	49	49	49
5	75	62	53	46	73	61	52	46	59	51	46	57	50	45	55	49	45	42	42	42	42	42	42	42
6	69	56	47	40	68	55	46	40	53	45	40	51	45	39	50	44	39	37	37	37	37	37	37	37
7	64	51	42	36	63	50	41	35	48	41	35	47	40	35	45	39	35	33	33	33	33	33	33	33
8	60	46	38	32	58	45	37	32	44	37	31	43	36	31	42	36	31	29	29	29	29	29	29	29
9	56	42	34	28	54	42	34	28	41	33	28	39	33	28	38	32	28	26	26	26	26	26	26	26
10	52	39	31	26	51	39	31	26	38	30	26	37	30	26	36	30	25	24	24	24	24	24	24	24

Zonal Lumen Summary

Zone	Lumens	% Fixture
0-30	891	26.4
0-40	1467	43.5
0-60	2630	78.0
0-90	3370	100.0
0-180	3370	100.0

## LUMEN MAINTENANCE

Ambient Temperature	TM-21 Lumen Maintenance (100,000 hours)	Theoretical L70 (Hours)
25°C	> 92%	> 448,000

Non-IC data

## ENERGY AND PERFORMANCE DATA BY CATALOG NUMBER

Stock or MTO*	Catalog Logic (Curved)	Delivered Lumens	Watts	Efficacy (LPW)
MTO	22EN-LD2-19-UNV-L830-CD1-U	1969	16.5	119
MTO	22EN-LD2-19-UNV-L835-CD1-U	2030	16.5	123
MTO	22EN-LD2-19-UNV-L840-CD1-U	2071	16.5	126
MTO	22EN-LD2-19-UNV-L850-CD1-U	2253	16.5	137
MTO	22EN-LD2-25-UNV-L830-CD1-U	2494	20.0	125
STOCK	22EN-LD2-25-UNV-L835-CD1-U	2571	20.0	129
STOCK	22EN-LD2-25-UNV-L840-CD1-U	2622	20.0	131
MTO	22EN-LD2-25-UNV-L850-CD1-U	2854	20.0	143
MTO	22EN-LD2-30-UNV-L830-CD1-U	2898	24.9	116
MTO	22EN-LD2-30-UNV-L835-CD1-U	2988	24.9	120
MTO	22EN-LD2-30-UNV-L840-CD1-U	3048	24.9	122
MTO	22EN-LD2-30-UNV-L850-CD1-U	3317	24.9	133
MTO	22EN-LD2-34-UNV-L830-CD1-U	3269	28.5	115
STOCK	22EN-LD2-34-UNV-L835-CD1-U	3370	28.5	118
STOCK	22EN-LD2-34-UNV-L840-CD1-U	3437	28.5	121
MTO	22EN-LD2-34-UNV-L850-CD1-U	3741	28.5	131
MTO	22EN-LD2-39-UNV-L830-CD1-U	3747	33.3	113
MTO	22EN-LD2-39-UNV-L835-CD1-U	3863	33.3	116
MTO	22EN-LD2-39-UNV-L840-CD1-U	3940	33.3	118
MTO	22EN-LD2-39-UNV-L850-CD1-U	4288	33.3	129
MTO	22EN-LD2-43-UNV-L830-CD1-U	4218	38.3	110
MTO	22EN-LD2-43-UNV-L835-CD1-U	4348	38.3	114
MTO	22EN-LD2-43-UNV-L840-CD1-U	4435	38.3	116
MTO	22EN-LD2-43-UNV-L850-CD1-U	4826	38.3	126

\*Made to order (MTO) requires a typical two week lead time.

ORDERING INFORMATION

SAMPLE NUMBER: 22EN-LD2-34-UNV-L835-CD1-SVPD1-U

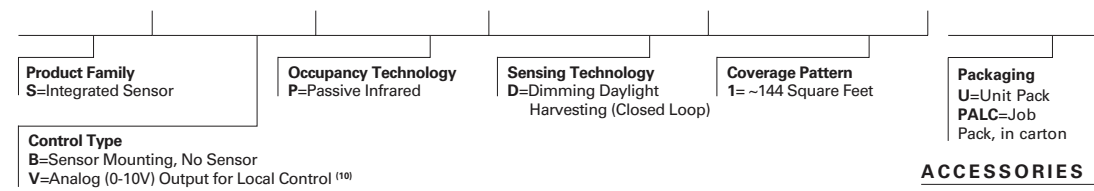
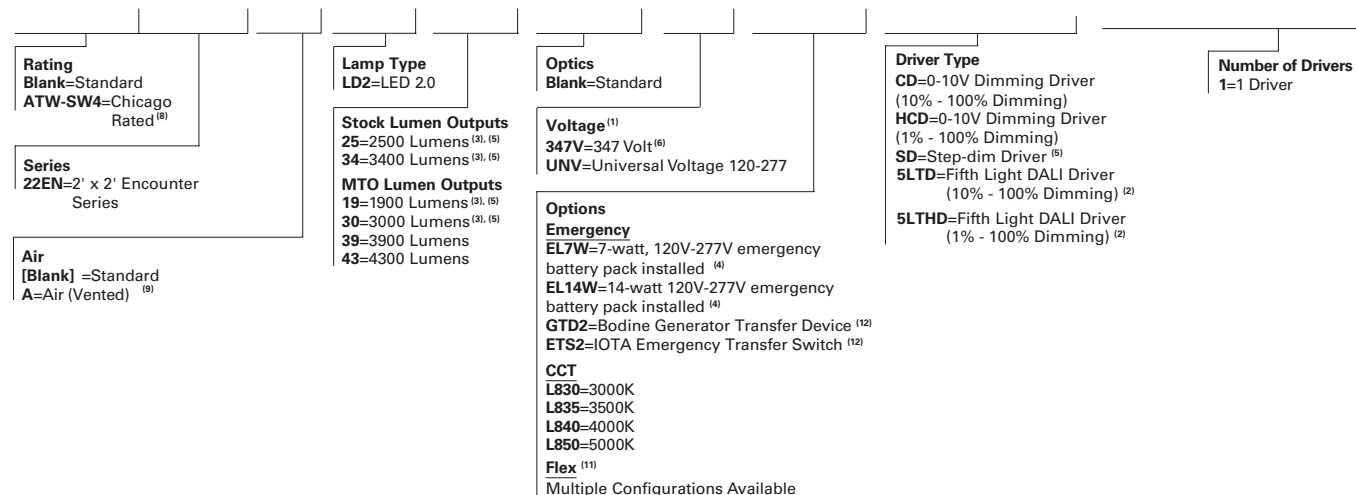

ACCESSORIES

- T3A END E.Q. BRACKET PARTS BAG (Standard with fixture)
- DF-22-W=2' x 2' Drywall Frame Kit
- SK-22-WS=2' x 2' Shallow Surface Mount Kit
- SK-22-WT=2' x 2' Tall Surface Mount Kit
- DF10P-C\_=Decorator Dimmer, 0-10V
- SF10P-\_=Decorator Slide Dimmer, 0-10V
- ISHH-01=Programming Remote for Integrated Sensor
- ISHH-02=Personal Control Remote for Integrated Sensor

NOTES: <sup>(1)</sup>Products also available in non-US voltages and frequencies for international markets. <sup>(2)</sup>Must be used in conjunction with a DALI control system. For complete DALI solutions by Fifth Light, visit [www.eaton.com/lightingsystems](http://www.eaton.com/lightingsystems) <sup>(3)</sup>1900, 2500, 3000 and 3400 lumen option are not available with a Fifth Light DALI (5LTD) driver. <sup>(4)</sup>With integral test switch/indicator/laser test. For approximate delivered lumens multiply the lumens per watt of the desired fixture by the wattage of the emergency battery pack (100 lm/W x 7=700 lumens). IES-format photometry for luminaire under emergency operation available. <sup>(5)</sup>Step-dim driver not available with 1900, 2500, 3000 and 3400 lumen option. <sup>(6)</sup>347V emergency option not available. <sup>(8)</sup>Chicago rated version does not allow for row mounting. <sup>(9)</sup>Air version is vented but does not meet air handling requirements; a 6% reduction in delivered lumens is experienced with this option. <sup>(10)</sup>Integral sensor works only with "CD" driver and is factory prewired to the driver for stand-alone control. <sup>(11)</sup>Flex does not include dimming leads. Control leads provided by others. <sup>(12)</sup>Used to transfer fixture to secondary power source for life-safety operation. When used with a dimming fixture, two devices are required to ensure control is disabled while operating under emergency power.

Specifications & dimensions subject to change without notice. Consult your Eaton Representative for availability and ordering information.

SHIPPING DATA

Catalog No.	Wt.
22EN-LD2-25	14 lbs.
22EN-LD2-34	14 lbs.

**INTEGRATED SENSOR**

The Encounter with Integrated Sensor technology provides automatic energy savings without sacrificing performance. Traditionally, these types of energy savings required coordination between the luminaire and a lighting control system. The Encounter delivers superior lighting with integrated occupancy and daylighting controls.

Capture the benefits of traditional lighting controls, without complicated coverage planning or special wiring. Ideal for new construction or retrofit, the Encounter delivers automatic ON to an energy saving light level, while ensuring lighting is turned OFF when the space is unoccupied.

The integral daylight sensor reduces the need for special daylight zone planning. Each luminaire will automatically adjust the light level based on reflected light beneath the sensor in a closed loop method.

Occupied daylight light levels and unoccupied light levels can be adjusted using the integrated sensor programming remote (Catalog Number: ISHH-01). The integrated sensor personal remote (Catalog Number: ISHH-02) provides code compliant manual raise, lower, ON, OFF control.

The Encounter with Integrated Sensor is easy to install with no special wiring and ensures energy savings out-of-the-box with default control settings.

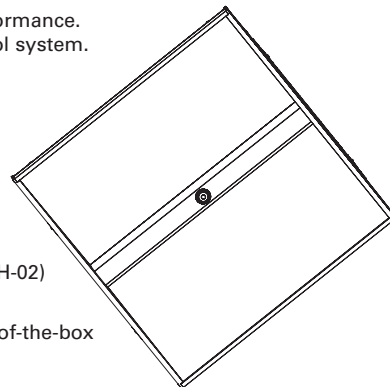

**How it works:**

- As the user enters the space controlled by the integral sensor, the lighting turns ON to the default daylight level.
- Lighting will remain at that the daylight level until the space is unoccupied. This will start the occupancy timeout period (default 20 minutes).
- If the space remains unoccupied for half of the timeout period, the lighting will automatically reduce to the Energy Saver light level. This adjustable light level is typically half of the occupied daylight level.
- At the end of the timeout period the lighting will go to the unoccupied light level. This adjustable light level uses the OFF default setting.

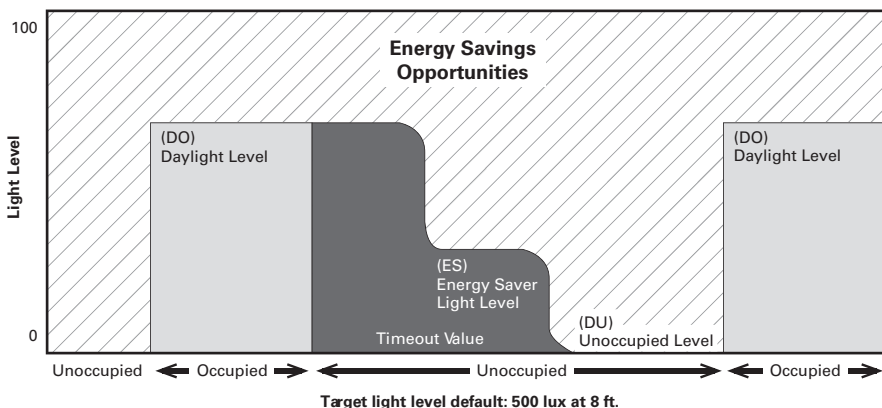

**Coverage**

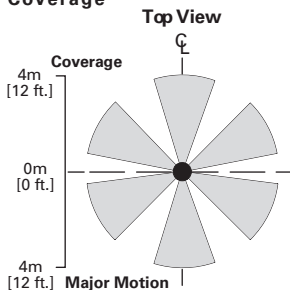

**Side View**

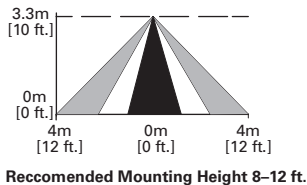

**Optional Remote Controls**



ISHH-01 Programming Remote



ISHH-02 Personal Control Remote