

DESCRIPTION

The Encounter™ redefines ambient lighting by being the first fixture to blend modern contemporary styling with the innovative WaveStream™ technology to deliver exceptional performance and superior energy savings. Encounter's highly efficient LED system with advance optical design delivers an unparalleled combination of optimal light uniformity for enhanced visual comfort and superior efficiency for greater energy savings.

Encounter is compatible with all of today's popular ceiling systems and available in a variety of configurations for application versatility. Its perfect balance of form and function make it an ideal choice for commercial office spaces, schools, hospitals, retail and other indoor ambient applications.

SPECIFICATION FEATURES

Construction

Shallow 3-1/4" deep housing is extruded aluminum frame and injected molded composite end plates. End plates are securely attached with screws for strength and rigidity and the elimination of gaps. End plates have accessory grid-lock feature for safety and convenience. Four auxiliary fixture end suspension points are provided. Large access plate for supply connection.

Controls

Equipped standard with a 0-10V continuous dimming driver that works with any standard 0-10V control/dimmer. Dimming range is 5% to 100%; varies by control device. Combine with energy-saving products like occupancy sensors, daylighting controls, and lighting relay panels from Cooper Controls (www.coopercontrol.com) to maximize energy savings.

Electrical

Long-life LED system coupled with electrical driver to deliver optimal performance. LED's available in 3000K, 3500K or 4000K with a typical CRI ≤ 85. Projected life is 60,000 hours at 78% lumen output. Electronic drivers are available for 120-277V applications.

Driver Access

Drivers can be accessed via plenum.

Finish

Durable frame has high reflectance baked matte white enamel finish for luminous uniformity.

Optics

Precision formed optical assembly with positively retained high optical grade acrylic lenses provide a directed optical distribution using WaveStream technology.

Compliance

Components are UL recognized. Indoor luminaires are cULus and CSA listed for 25° C ambient environments, RoHS compliant, and comply with IESNA LM-79. LEDs comply with LM-80 standards. DesignLights™ Consortium Qualified. Refer to www.designlights.org Qualified Products List under Family Models for details.

Warranty

Five year warranty.

Catalog #		Type
Project		
Comments		Date
Prepared by		

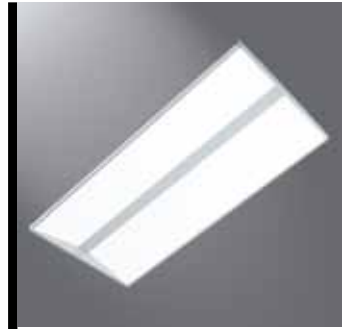

**24EN
LED**

**2' X 4' TROFFER
LED MODULE**

Specification Grade Troffer

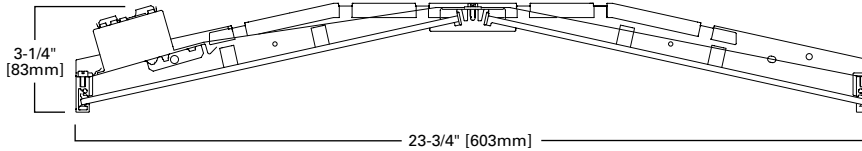

MOUNTING DATA

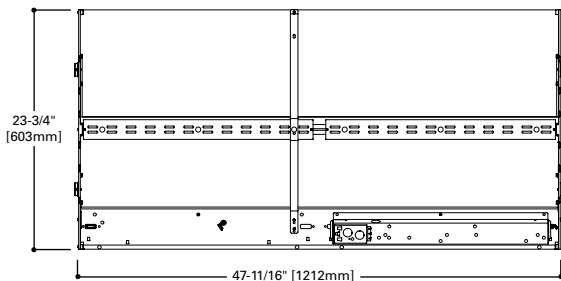

LAMP CONFIGURATIONS

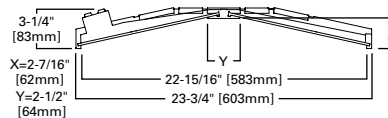

CERTIFICATION DATA

cULus - Damp Location
CSA
IC Rated
LM79/LM80 Compliant
ROHS Compliant
DesignLights™ Consortium Qualified
Title 24

*See Drywall Frame Kit Accessory in Ordering Information section.

CEILING COMPATIBILITY

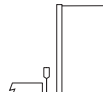
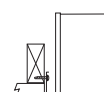
G	F	Ceiling Type	Trim Type
Grid/Lay-in Standard	Drywall Frame Kit	Exposed Grid	G
		Concealed T	G or T
		Slot Grid	G or T
		Flange	*

LINEAR DISCONNECT

Safe and convenient means of disconnecting power

PHOTOMETRICS

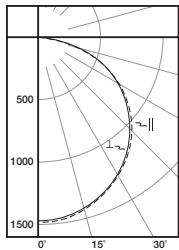

24EN-LD1-45-UNV-L835-CD1-U
 Electronic Driver
 Linear LED 3500K
 Spacing criterion:
 (H) 1.3 x mounting
 height, (L) 1.3 x
 mounting height
 Lumens: 4504
 Input Watts: 40.0W
 Efficacy: 96 LPW
 Test Report:
 24EN-LD1-44-UNV-
 L835-CD1-U.IES

Candlepower			
Angle	Along H	45°	Across L
0	1471	1471	1471
5	1473	1467	1467
10	1456	1448	1449
15	1425	1417	1417
20	1384	1374	1371
25	1332	1321	1315
30	1273	1260	1251
35	1204	1188	1179
40	1128	1111	1102
45	1046	1028	1022
50	954	936	932
55	854	834	832
60	744	722	728
65	625	601	617
70	494	480	472
75	357	347	302
80	219	195	210
85	99	96	97
90	0	0	0

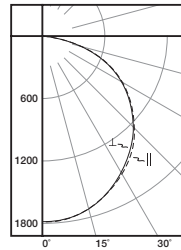

24EN-LD1-54-UNV-L835-CD1-U
 Electronic Driver
 Linear LED 3500K
 Spacing criterion:
 (H) 1.3 x mounting
 height, (L) 1.3 x
 mounting height
 Lumens: 5421
 Input Watts: 54.4W
 Efficacy: 100 LPW
 Test Report:
 24EN-LD1-54-UNV-
 L835-CD1-U.IES

Candlepower			
Angle	Along H	45°	Across L
0	1782	1782	1782
5	1781	1779	1780
10	1760	1758	1759
15	1724	1720	1720
20	1674	1669	1664
25	1614	1605	1595
30	1537	1526	1514
35	1455	1443	1424
40	1359	1346	1331
45	1260	1241	1231
50	1145	1130	1119
55	1023	1001	996
60	890	865	865
65	745	716	728
70	587	571	554
75	422	413	357
80	260	232	247
85	118	112	115
90	0	0	0

Coefficients of Utilization

rc	Effective floor cavity reflectance																	
	80%			70%			50%			30%			10%			0%		
rw	70	50	30	70	50	30	70	50	30	70	50	30	70	50	30	0		
RCR																		
0	119	119	119	119	116	116	116	111	111	111	106	106	106	102	102	102	100	
1	108	103	99	95	105	101	97	93	97	93	90	93	90	87	89	87	85	83
2	98	89	82	76	95	87	81	75	84	78	74	81	76	72	77	74	70	68
3	89	78	70	63	86	76	69	62	73	67	61	71	65	60	68	63	59	57
4	81	69	60	53	79	68	59	53	65	58	52	63	56	51	60	55	50	48
5	75	61	52	45	72	60	52	45	58	50	45	56	49	44	54	48	44	41
6	69	55	46	39	67	54	45	39	52	45	39	51	44	38	49	43	38	36
7	64	50	41	35	62	49	41	34	47	40	34	46	39	34	45	38	34	32
8	59	45	37	31	58	45	36	31	43	36	30	42	35	30	41	35	30	28
9	55	42	33	28	54	41	33	28	40	33	27	39	32	27	38	32	27	25
10	52	38	30	25	51	38	30	25	37	30	25	36	29	25	35	29	25	23

Coefficients of Utilization

rc	Effective floor cavity reflectance																	
	80%			70%			50%			30%			10%			0%		
rw	70	50	30	70	50	30	70	50	30	70	50	30	70	50	30	0		
RCR																		
0	119	119	119	119	116	116	116	111	111	111	106	106	106	102	102	102	100	
1	108	103	99	95	105	101	97	93	97	93	90	93	90	87	89	87	85	83
2	98	89	82	76	95	88	81	75	84	78	74	81	76	72	78	74	70	68
3	89	78	70	63	87	77	69	62	74	67	61	71	65	60	68	63	59	57
4	81	69	60	53	79	68	59	53	65	58	52	63	56	51	61	55	51	48
5	75	62	52	45	73	60	52	45	58	51	45	56	49	44	54	48	44	42
6	69	55	46	39	67	54	46	39	52	45	39	51	44	39	49	43	38	36
7	64	50	41	35	62	49	41	35	48	40	34	46	39	34	45	39	34	32
8	59	46	37	31	58	45	37	31	44	36	31	42	35	30	41	35	30	28
9	55	42	33	28	54	41	33	28	40	33	28	39	32	27	38	32	27	25
10	52	39	30	25	51	38	30	25	37	30	25	36	29	25	35	29	25	23

Zonal Lumen Summary

Zone	Lumens	%Fixture
0-30	1149	25.5
0-40	1893	42.0
0-60	3436	76.3
0-90	4504	100.0
0-180	4504	100.0

Luminance Data

Angle in Deg	Average 0-Deg cd/sm	Average 45-Deg cd/sm	Average 90-Deg cd/sm
45	1990	1955	1944
55	2003	1956	1951
65	1989	1913	1964
75	1855	1803	1569
85	1528	1481	1497

Zonal Lumen Summary

Zone	Lumens	%Fixture
0-30	1393	25.7
0-40	2295	42.3
0-60	4152	76.6
0-90	5421	100.0
0-180	5421	100.0

Luminance Data

Angle in Deg	Average 0-Deg cd/sm	Average 45-Deg cd/sm	Average 90-Deg cd/sm
45	2397	2361	2342
55	2399	2347	2336
65	2371	2279	2317
75	2193	2146	1855
85	1821	1728	1775

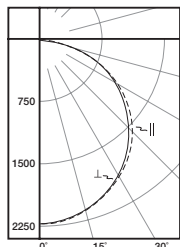

24EN-LD1-67-UNV-L835-CD1-U
 Electronic Driver
 Linear LED 3500K
 Spacing criterion:
 (H) 1.3 x mounting
 height, (L) 1.3 x
 mounting height
 Lumens: 6730
 Input Watts: 70.2W
 Efficacy: 96 LPW
 Test Report:
 24EN-LD1-66-UNV-
 L835-CD1-U.IES

Candlepower			
Angle	Along H	45°	Across L
0	2212	2212	2212
5	2219	2205	2205
10	2192	2178	2179
15	2149	2132	2132
20	2086	2068	2063
25	2009	1989	1976
30	1917	1893	1878
35	1814	1787	1768
40	1695	1667	1651
45	1570	1541	1526
50	1431	1400	1388
55	1280	1243	1230
60	1111	1071	1073
65	933	886	908
70	730	706	689
75	524	510	436
80	323	286	307
85	149	142	141
90	0	0	0

Coefficients of Utilization

rc	Effective floor cavity reflectance																	
	80%			70%			50%			30%			10%			0%		
rw	70	50	30	70	50	30	70	50	30	70	50	30	70	50	30	0		
RCR																		
0	119	119	119	119	116	116	116	111	111	111	106	106	106	102	102	102	100	
1	108	103	99	95	105	101	97	93	97	93	90	93	90	87	89	87	85	83
2	98	89	82	76	95	88	81	75	84	78	74	81	76	72	78	74	70	68
3	89	78	70	63	87	77	69	62	74	67	61	71	65	60	68	63	59	57
4	81	69	60	53	79	68	59	53	65	58	52	63	56	51	61	55	51	48
5	75	62	52	45	73	60	52	45	58	51	45	56	49	44	54	48	44	42
6	69	55	46	40	67	54	46	39	52	45	39	51	44	39	49	43	38	36
7	64	50	41	35	62	49	41	35	48	40	34	46	39	34	45	39	34	32
8	59	46	37	31	58	45	37	31	44	36	31	42	35	30	41	35	30	28
9	55	42	33	28	54	41	33	28	40	33	28	39	32	27	38	32	27	25
10	52	39	30	25	51	38	30	25	37	30	25	36	29	25	35	29	25	23

Zonal Lumen Summary

Zone	Lumens	%Fixture
0-30	1730	25.7
0-40	2849	42.3
0-60	5155	76.6
0-90	6730	100.0
0-180	6730	100.0

Luminance Data

Angle in Deg	Average 0-Deg cd/sm	Average 45-Deg cd/sm	Average 90-Deg cd/sm
45	2986	2931	2903
55	3002	2915	2884
65	2969	2820	2890
75	2723	2650	2266
85	2299	2191	2176

LUMEN MAINTENANCE

Ambient Temperature	TM-21 Lumen Maintenance (60,000 hours)	Theoretical L70 (Hours)
25°C	> 78%	> 92,000

ENERGY AND PERFORMANCE DATA BY CATALOG NUMBER

Stock or MTO*	Catalog Logic	Delivered Lumens	Watts	Efficacy (LPW)
MTO	24EN-LD1-30-UNV-L830-CD1-U	2928	29.8	98
MTO	24EN-LD1-30-UNV-L835-CD1-U	3040	30.1	101
MTO	24EN-LD1-30-UNV-L840-CD1-U	3114	29.9	104
MTO	24EN-LD1-34-UNV-L830-CD1-U	3326	34.3	97
MTO	24EN-LD1-34-UNV-L835-CD1-U	3449	34.5	100
MTO	24EN-LD1-34-UNV-L840-CD1-U	3536	34.4	103
MTO	24EN-LD1-40-UNV-L830-CD1-U	3898	41.0	95
MTO	24EN-LD1-40-UNV-L835-CD1-U	4039	41.3	98
MTO	24EN-LD1-40-UNV-L840-CD1-U	4141	41.1	101
MTO	24EN-LD1-45-UNV-L830-CD1-U	4333	46.7	93
Stock	24EN-LD1-45-UNV-L835-CD1-U	4504	47.0	96
Stock	24EN-LD1-45-UNV-L840-CD1-U	4618	46.8	99
MTO	24EN-LD1-49-UNV-L830-CD1-U	4884	49.1	99
MTO	24EN-LD1-49-UNV-L835-CD1-U	4962	49.3	101
MTO	24EN-LD1-49-UNV-L840-CD1-U	5141	49.4	104
MTO	24EN-LD1-54-UNV-L830-CD1-U	5329	54.3	98
Stock	24EN-LD1-54-UNV-L835-CD1-U	5421	54.4	100
Stock	24EN-LD1-54-UNV-L840-CD1-U	5614	54.6	103
MTO	24EN-LD1-58-UNV-L830-CD1-U	5763	59.5	97
MTO	24EN-LD1-58-UNV-L835-CD1-U	5856	59.5	98
MTO	24EN-LD1-58-UNV-L840-CD1-U	6070	59.8	102
MTO	24EN-LD1-67-UNV-L830-CD1-U	6598	70.0	94
Stock	24EN-LD1-67-UNV-L835-CD1-U	6730	70.2	96
Stock	24EN-LD1-67-UNV-L840-CD1-U	6938	70.2	99
MTO	24EN-LD1-70-UNV-L830-CD1-U	6948	74.9	93
MTO	24EN-LD1-70-UNV-L835-CD1-U	7077	74.9	94
MTO	24EN-LD1-70-UNV-L840-CD1-U	7303	74.9	98
MTO**	24EN-LD1-74-UNV-L830-CD1-U	7341	80.0	92
MTO**	24EN-LD1-74-UNV-L835-CD1-U	7443	80.0	93
MTO**	24EN-LD1-74-UNV-L840-CD1-U	7683	80.0	96

*Made to order (MTO) requires a four week lead time.
**Available December 2013

ORDERING INFORMATION

SAMPLE NUMBER: 24EN-LD1-67-UNV-L835-CD1-U

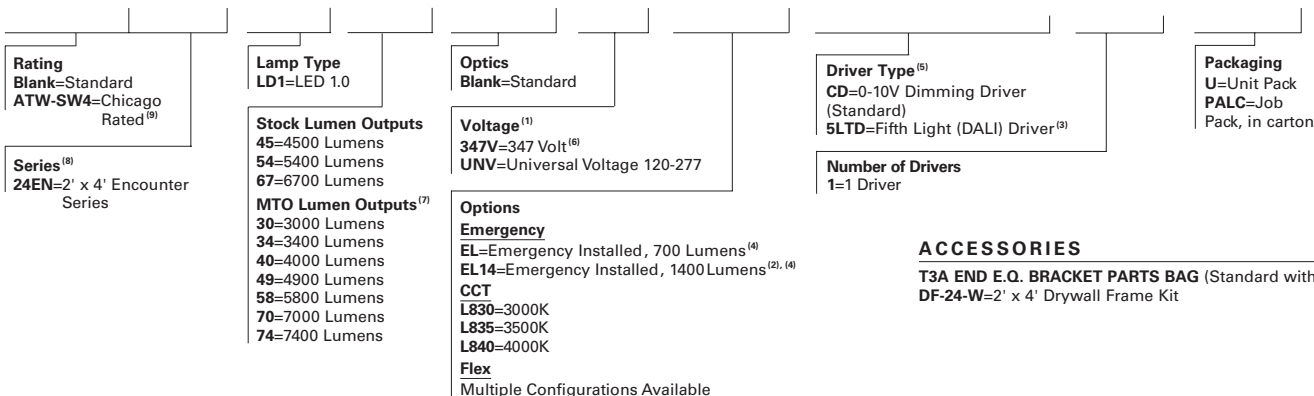

ACCESSORIES

T3A END E.Q. BRACKET PARTS BAG (Standard with fixture)
DF-24-W=2' x 4' Drywall Frame Kit

NOTES: ⁽¹⁾ Products also available in non-US voltages and frequencies for international markets. ⁽²⁾ Must specify voltage (120V or 277V) when selecting EL option. ⁽⁴⁾ EL options are non-integral, test switch and light must be remote mounted. EL700 option requires standard switch box. ⁽⁵⁾ Call factory for step-dimming options. ⁽⁶⁾ 347V emergency option not available. ⁽⁷⁾ Made-to-order (MTO) requires four week lead time. ⁽⁸⁾ DesignLights™ Consortium Qualified (all lumen packages). Refer to www.designlights.org Qualified Products List under Family Models for details.

⁽⁹⁾ Chicago rated version does not allow for row mounting.

SHIPPING DATA

Catalog No.	Wt.
24EN-LD1-45	28 lbs.
24EN-LD1-54	28 lbs.
24EN-LD1-67	28 lbs.



Specifications and dimensions subject to change without notice.