

DESCRIPTION

The Encounter™ redefines ambient lighting by being the first fixture to blend modern contemporary styling with the innovative WaveStream™ technology to deliver exceptional performance and superior energy savings. Encounter's highly efficient LED system with advance optical design delivers an unparalleled combination of optimal light uniformity for enhanced visual comfort and superior efficiency for greater energy savings.

Encounter is compatible with all of today's popular ceiling systems and available in a variety of configurations for application versatility. Its perfect balance of form and function make it an ideal choice for commercial office spaces, schools, hospitals, retail and other indoor ambient applications.

SPECIFICATION FEATURES

Construction

Shallow 3-1/4" deep housing is extruded aluminum frame and injected molded composite end plates. End plates are securely attached with screws for strength and rigidity and the elimination of gaps. End plates have accessory grid-lock feature for safety and convenience. Four auxiliary fixture end suspension points are provided. Large access plate for supply connection.

Controls

The Encounter LED is Powered by Fifth Light, with a standard 0-10V continuous dimming driver that works with any 0-10V control/dimmer. Combine with energy saving products like occupancy sensors, daylighting controls and lighting relay panels to maximize energy savings. In addition, the Encounter can include a factory-installed integrated sensor system for occupancy and daylight dimming control and manual control from an optional handheld remote. Or, specify the Digital Addressable Lighting Interface (DALI) drivers, dimmable down to 1% with the HD option, for use with Fifth Light controls. See ordering information for details on all three options.

Electrical

Long-life LED system coupled with electrical driver to deliver optimal performance. LED's available in 3000K, 3500K, 4000K or 5000K with a typical CRI ≤ 85. Projected life is 100,000 hours at 92% lumen output. Electronic drivers are available for 120-277V applications.

Emergency Battery Pack Option

Optional 120v-277v integral emergency battery pack is available in 7-watts or 14-watts to meet critical life-safety lighting requirements. The 90-minute batteries provide constant power to the LED system, ensuring code-compliance. A test switch/indicator button can be tested safely from the ground using a laser pointer, while the patented EZ Key prevents accidental discharge of the battery during construction. See ordering information for details.

Driver Access

Drivers can be accessed via plenum.

Finish

Durable frame has high reflectance baked matte white enamel finish for luminous uniformity.

Optics

Precision formed optical assembly with positively retained high optical grade acrylic lenses provide a directed optical distribution using WaveStream technology.

Compliance

Components are UL recognized. Indoor luminaires are cULus and CSA listed for 25° C ambient environments, RoHS compliant, and comply with IESNA LM-79. LEDs comply with LM-80 standards.

Warranty

Five year warranty.



**22EN
LED**

**2' X 2' TROFFER
LED MODULE**

Specification Grade Troffer



powered by
fifthlight
technology

CERTIFICATION DATA

cULus - 1598 and 2043**
Damp Location Listed
CSA
IC Rated
LM79/LM80 Compliant
ROHS Compliant
NOM Compliant

*See Drywall Frame Kit Accessory in Ordering Information section.

**Fixture construction is suitable for use in Air-handling and plenum rated spaces in accordance with Section 300.22 (C) of the National Electrical Code, Section 4.3.11.2.6.5 of NFPA 90A and Section 602.2.1.4 of ICC.

LINEAR DISCONNECT

Safe and convenient means of disconnecting power



PS519064EN
2016-02-12 13:12:20

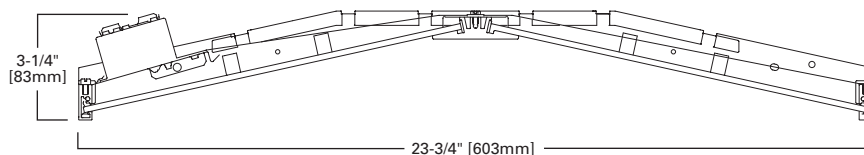

MOUNTING DATA

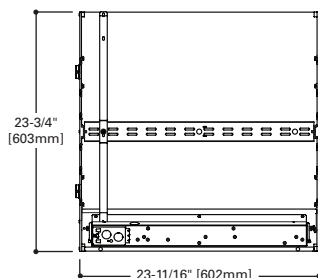

LAMP CONFIGURATIONS

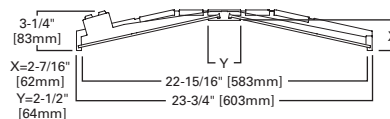

CEILING COMPATIBILITY

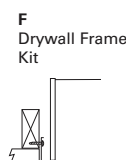
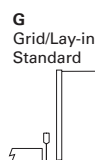

**Ceiling
Type**

Exposed Grid
Concealed T
Slot Grid
Flange

**Trim
Type**

G
G or T
G or T
*

PHOTOMETRICS

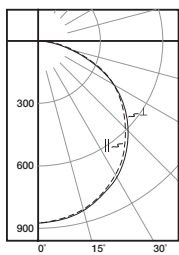

22EN-LD2-25-UNV-L835-CD1-U

Electronic Driver
 Linear LED 3500K
 Spacing criterion:
 (II) 1.3 x mounting
 height, () 1.3 x
 mounting height
 Lumens: 2571
 Input Watts: 20.9W
 Efficacy: 122.5 lm/W
 Test Report:
 22EN-LD2-25-UNV-
 L835-CD1-U.IES

Candlepower			
Angle	Along II	45°	Across
0	873	873	873
5	869	868	871
10	856	856	861
15	837	837	844
20	811	811	819
25	780	779	790
30	741	741	753
35	700	698	711
40	650	649	662
45	598	595	608
50	539	535	549
55	474	472	486
60	405	402	421
65	335	328	348
70	259	255	257
75	185	178	157
80	111	97	103
85	41	43	43
90	0	0	0

Coefficients of Utilization

rc rw RCR	Effective floor cavity reflectance 20%																	
	80%			70%			50%			30%			10%			0%		
	70	50	30	70	50	30	50	30	10	50	30	10	50	30	10	0		
0	119	119	119	116	116	116	111	111	111	106	106	106	102	102	102	100		
1	109	104	99	95	106	101	97	94	97	94	91	93	91	88	90	87	85	83
2	99	90	83	77	96	88	82	76	85	79	75	81	77	73	78	75	71	69
3	90	79	71	64	87	77	70	63	74	68	62	72	66	61	69	64	60	58
4	82	70	61	54	80	68	60	54	66	59	53	64	57	52	61	56	51	49
5	75	62	53	46	73	61	52	46	59	51	46	57	50	45	55	49	45	42
6	69	56	47	40	68	55	46	40	53	45	40	51	45	39	50	44	39	37
7	64	51	42	36	63	50	41	35	48	41	35	47	40	35	45	39	35	33
8	60	46	38	32	58	45	37	32	44	37	31	43	36	31	42	36	31	29
9	56	42	34	28	54	42	34	28	41	33	28	39	33	28	38	32	28	26
10	52	39	31	26	51	39	31	26	38	30	26	37	30	25	36	30	25	24

Zonal Lumen Summary

Zone	Lumens	% Fixture
0-30	680	26.4
0-40	1118	43.5
0-60	2005	78.0
0-90	2571	100.0
0-180	2571	100.0

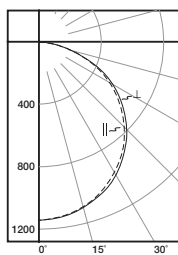

22EN-LD2-34-UNV-L835-CD1-U

Electronic Driver
 Linear LED 3500K
 Spacing criterion:
 (II) 1.3 x mounting
 height, (L) 1.3 x
 mounting height
 Lumens: 3370
 Input Watts: 28.5W
 Efficacy: 118.2 lm/W
 Test Report:
 22EN-LD2-34-UNV-
 L835-CD1-U.IES

Candlepower			
Angle	Along II	45°	Across ⊥
0	1142	1142	1142
5	1137	1136	1141
10	1121	1120	1127
15	1098	1097	1106
20	1064	1064	1075
25	1023	1023	1037
30	974	971	988
35	918	917	933
40	854	852	869
45	784	780	800
50	708	702	722
55	624	618	638
60	534	526	553
65	440	431	457
70	339	334	340
75	241	232	205
80	145	126	135
85	54	56	58
90	0	0	0

Coefficients of Utilization

rc rw RCR	Effective floor cavity reflectance 20%																	
	80%			70%			50%			30%			10%			0%		
	70	50	30	70	50	30	50	30	10	50	30	10	50	30	10	0		
0	119	119	119	116	116	116	111	111	111	106	106	106	102	102	102	100		
1	109	104	99	95	106	101	97	94	97	94	91	93	91	88	90	87	85	83
2	99	90	83	77	96	88	82	76	85	79	75	81	77	73	78	75	71	69
3	90	79	71	64	87	77	70	63	74	68	62	72	66	61	69	64	60	58
4	82	70	61	54	80	68	60	54	66	59	53	64	57	52	61	56	51	49
5	75	62	53	46	73	61	53	46	59	51	46	57	50	45	55	49	45	42
6	69	56	47	40	68	55	46	40	53	45	40	51	45	39	50	44	39	37
7	64	51	42	36	63	50	41	35	48	41	35	47	40	35	45	39	35	33
8	60	46	38	32	58	45	37	32	44	37	31	43	36	31	42	36	31	29
9	56	42	34	28	54	42	34	28	41	33	28	39	33	28	38	32	28	26
10	52	39	31	26	51	39	31	26	38	30	26	37	30	25	36	30	25	24

Zonal Lumen Summary

Zone	Lumens	% Fixture
0-30	891	26.4
0-40	1467	43.5
0-60	2630	78.0
0-90	3370	100.0
0-180	3370	100.0

LUMEN MAINTENANCE

Ambient Temperature	TM-21 Lumen Maintenance (100,000 hours)	Theoretical L70 (Hours)
25°C	> 92%	> 448,000

Non-IC data

ENERGY AND PERFORMANCE DATA BY CATALOG NUMBER

Stock or MTO*	Catalog Logic (Curved)	Delivered Lumens	Watts	Efficacy (LPW)
MTO	22EN-LD2-19-UNV-L830-CD1-U	1969	16.5	119
MTO	22EN-LD2-19-UNV-L835-CD1-U	2030	16.5	123
MTO	22EN-LD2-19-UNV-L840-CD1-U	2071	16.5	126
MTO	22EN-LD2-19-UNV-L850-CD1-U	2253	16.5	137
MTO	22EN-LD2-25-UNV-L830-CD1-U	2494	20.0	125
STOCK	22EN-LD2-25-UNV-L835-CD1-U	2571	20.0	129
STOCK	22EN-LD2-25-UNV-L840-CD1-U	2622	20.0	131
MTO	22EN-LD2-25-UNV-L850-CD1-U	2854	20.0	143
MTO	22EN-LD2-30-UNV-L830-CD1-U	2898	24.9	116
MTO	22EN-LD2-30-UNV-L835-CD1-U	2988	24.9	120
MTO	22EN-LD2-30-UNV-L840-CD1-U	3048	24.9	122
MTO	22EN-LD2-30-UNV-L850-CD1-U	3317	24.9	133
MTO	22EN-LD2-34-UNV-L830-CD1-U	3269	28.5	115
STOCK	22EN-LD2-34-UNV-L835-CD1-U	3370	28.5	118
STOCK	22EN-LD2-34-UNV-L840-CD1-U	3437	28.5	121
MTO	22EN-LD2-34-UNV-L850-CD1-U	3741	28.5	131
MTO	22EN-LD2-39-UNV-L830-CD1-U	3747	33.3	113
MTO	22EN-LD2-39-UNV-L835-CD1-U	3863	33.3	116
MTO	22EN-LD2-39-UNV-L840-CD1-U	3940	33.3	118
MTO	22EN-LD2-39-UNV-L850-CD1-U	4288	33.3	129
MTO	22EN-LD2-43-UNV-L830-CD1-U	4218	38.3	110
MTO	22EN-LD2-43-UNV-L835-CD1-U	4348	38.3	114
MTO	22EN-LD2-43-UNV-L840-CD1-U	4435	38.3	116
MTO	22EN-LD2-43-UNV-L850-CD1-U	4826	38.3	126

*Made to order (MTO) requires a typical two week lead time.

ORDERING INFORMATION

SAMPLE NUMBER: 22EN-LD2-34-UNV-L835-CD1-SVPD1-U

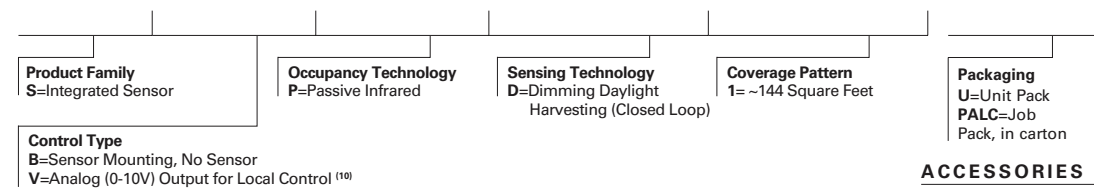
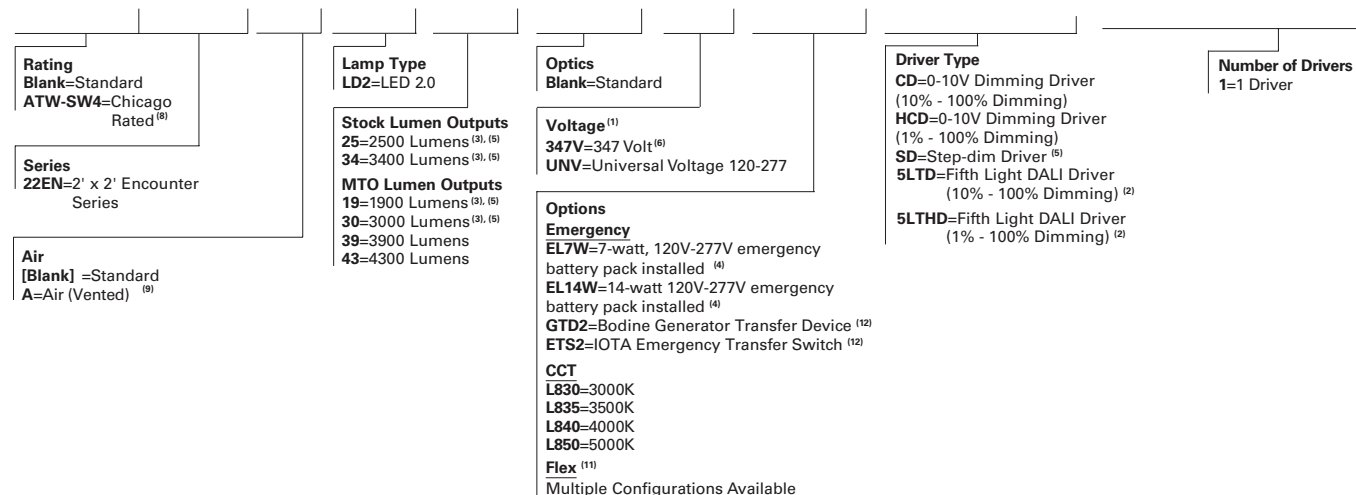

ACCESSORIES

- T3A END E.Q. BRACKET PARTS BAG (Standard with fixture)
- DF-22-W=2' x 2' Drywall Frame Kit
- SK-22-WS=2' x 2' Shallow Surface Mount Kit
- SK-22-WT=2' x 2' Tall Surface Mount Kit
- DF10P-C_=Decorator Dimmer, 0-10V
- SF10P-_=Decorator Slide Dimmer, 0-10V
- ISHH-01=Programming Remote for Integrated Sensor
- ISHH-02=Personal Control Remote for Integrated Sensor

NOTES: ⁽¹⁾Products also available in non-US voltages and frequencies for international markets. ⁽²⁾Must be used in conjunction with a DALI control system. For complete DALI solutions by Fifth Light, visit www.eaton.com/lightingsystems ⁽³⁾1900, 2500, 3000 and 3400 lumen option are not available with a Fifth Light DALI (5LTD) driver. ⁽⁴⁾With integral test switch/indicator/laser test. For approximate delivered lumens multiply the lumens per watt of the desired fixture by the wattage of the emergency battery pack (100 lm/W x 7=700 lumens). IES-format photometry for luminaire under emergency operation available. ⁽⁵⁾Step-dim driver not available with 1900, 2500, 3000 and 3400 lumen option. ⁽⁶⁾347V emergency option not available. ⁽⁸⁾Chicago rated version does not allow for row mounting. ⁽⁹⁾Air version is vented but does not meet air handling requirements; a 6% reduction in delivered lumens is experienced with this option. ⁽¹⁰⁾Integral sensor works only with "CD" driver and is factory prewired to the driver for stand-alone control. ⁽¹¹⁾Flex does not include dimming leads. Control leads provided by others. ⁽¹²⁾Used to transfer fixture to secondary power source for life-safety operation. When used with a dimming fixture, two devices are required to ensure control is disabled while operating under emergency power.

Specifications & dimensions subject to change without notice. Consult your Eaton Representative for availability and ordering information.

SHIPPING DATA

Catalog No.	Wt.
22EN-LD2-25	14 lbs.
22EN-LD2-34	14 lbs.

INTEGRATED SENSOR

The Encounter with Integrated Sensor technology provides automatic energy savings without sacrificing performance. Traditionally, these types of energy savings required coordination between the luminaire and a lighting control system. The Encounter delivers superior lighting with integrated occupancy and daylighting controls.

Capture the benefits of traditional lighting controls, without complicated coverage planning or special wiring. Ideal for new construction or retrofit, the Encounter delivers automatic ON to an energy saving light level, while ensuring lighting is turned OFF when the space is unoccupied.

The integral daylight sensor reduces the need for special daylight zone planning. Each luminaire will automatically adjust the light level based on reflected light beneath the sensor in a closed loop method.

Occupied daylight light levels and unoccupied light levels can be adjusted using the integrated sensor programming remote (Catalog Number: ISHH-01). The integrated sensor personal remote (Catalog Number: ISHH-02) provides code compliant manual raise, lower, ON, OFF control.

The Encounter with Integrated Sensor is easy to install with no special wiring and ensures energy savings out-of-the-box with default control settings.

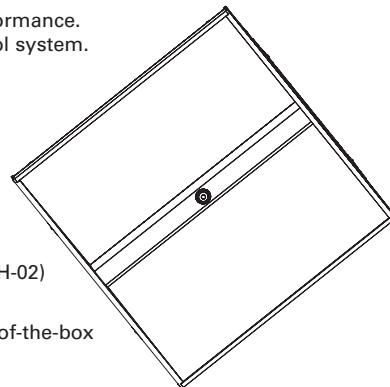

How it works:

- As the user enters the space controlled by the integral sensor, the lighting turns ON to the default daylight level.
- Lighting will remain at that the daylight level until the space is unoccupied. This will start the occupancy timeout period (default 20 minutes).
- If the space remains unoccupied for half of the timeout period, the lighting will automatically reduce to the Energy Saver light level. This adjustable light level is typically half of the occupied daylight level.
- At the end of the timeout period the lighting will go to the unoccupied light level. This adjustable light level uses the OFF default setting.

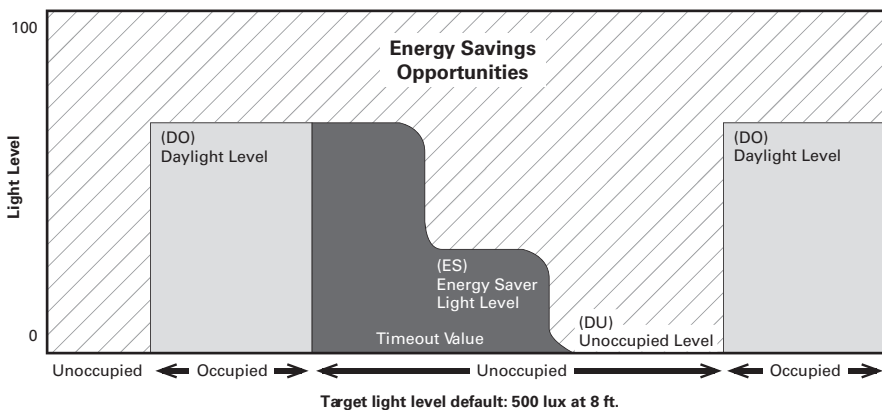

Coverage

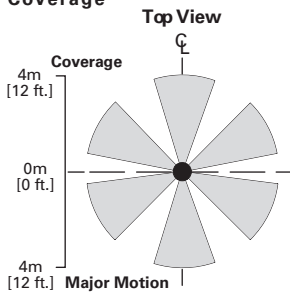

Side View

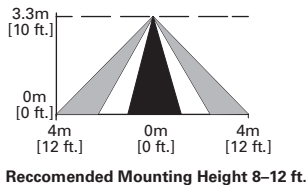

Optional Remote Controls



ISHH-01 Programming Remote



ISHH-02 Personal Control Remote