

**DESCRIPTION**

The SkyRidge™ transforms ambient lighting by perfectly blending a refined modern styling with our breakthrough WaveStream™ LED technology to deliver exceptional performance and superior energy savings. SkyRidge's advanced engineered LED system with superior optical design delivers an unparalleled combination of optimal light uniformity and exceptional efficiency for greater energy savings.

SkyRidge is compatible with all of today's popular ceiling systems and available in a variety of configurations for application versatility. Its perfect balance of form and function make it an ideal choice for commercial office spaces, schools, hospitals, retail and other indoor ambient applications.

**SPECIFICATION FEATURES**

**Construction**

Shallow 4.75" deep housing is extruded aluminum frame and injected molded composite end plates. End plates are securely attached with screws for strength and rigidity and the elimination of gaps. End plates have accessory grid-lock feature for safety and convenience. Four auxiliary fixture end suspension points are provided. Large access plate for supply connection.

**Controls**

The SkyRidge LED is Powered by Fifth Light, with a standard 0-10V continuous dimming driver that works with any 0-10V control/dimmer. Combine with energy saving products like occupancy sensors, daylighting controls and lighting relay panels to maximize energy savings. In addition, the SkyRidge can include a factory-installed integrated sensor system for occupancy and daylight dimming control and manual control from an optional handheld remote. Or, specify the Digital Addressable Lighting Interface (DALI) drivers, dimmable down to 1% with the HD option, for use with Fifth Light controls. See ordering information for details on all three options.

**Electrical**

Long-life LED system coupled with electrical driver to deliver optimal performance. LED's available in 3000K, 3500K, 4000K or 5000K with a typical CRI ≥ 85. Projected life is 100,000 hours at 92% lumen output. Electronic drivers are available for 120-277V applications.

**Emergency Battery Pack Option**

Optional 120v-277v integral emergency battery pack is available in 7-watts or 14-watts to meet critical life-safety lighting requirements. The 90-minute batteries provide constant power to the LED system, ensuring code-compliance. A test switch/indicator button can be tested safely from the ground using a laser pointer, while the patented EZ Key prevents accidental discharge of the battery during construction. See ordering information for details.

**Driver Access**

Drivers can be accessed via plenum.

**Finish**

Durable frame has high reflectance baked matte white enamel finish for luminous uniformity.

**Optics**

Precision formed optical assembly with positively retained high optical grade acrylic lens provides a directed optical distribution using WaveStream LED technology.

**SkyTrim Accessory**

Designed for an array of interior applications, SkyTrim is a luminous decorative accent that can be mounted directly on the light guide of a SkyRidge fixture either at the factory or in the field. It is ideal for spaces where color is necessary to provide visual cues, emphasize brand identity, directional awareness or simply as an artistic expression.

**Compliance**

Components are UL recognized. Indoor luminaires are cULus listed for 25° C ambient environments, RoHS compliant, and comply with IESNA LM-79. LEDs comply with LM-80 standards.

**Warranty**

Five year warranty.



**24SR  
LED**

**2' X 4' TROFFER  
LED MODULE**

Specification Grade Troffer



**CURVED**

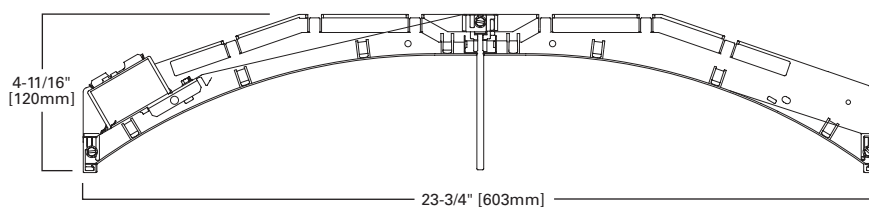

**MOUNTING DATA**

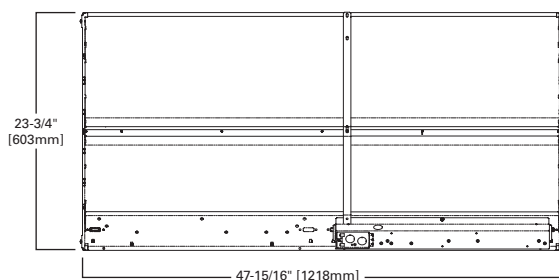

**LAMP CONFIGURATIONS**

**CURVED**

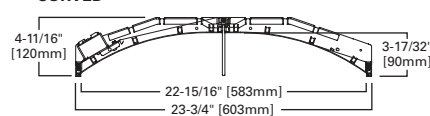

**STRAIGHT**

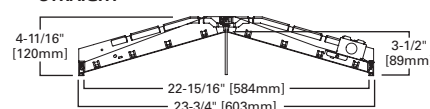

\*See Drywall Frame Kit Accessory in Ordering Information section.

\*\*Fixture construction is suitable for use in Air-handling and plenum rated spaces in accordance with Section 300.22 (C) of the National Electrical Code, Section 4.3.11.2.6.5 of NFPA 90A and Section 602.2.1.4 of ICC.

**LINEAR DISCONNECT**

Safe and convenient means of disconnecting power



**CEILING COMPATIBILITY**

**G**  
Grid/Lay-in  
Standard

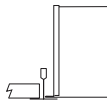

**F**  
Drywall Frame  
Kit

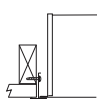

**Ceiling Type**  
Exposed Grid  
Concealed T  
Slot Grid  
Flange

**Trim Type**  
G  
G or T  
G or T  
\*

**PHOTOMETRICS**

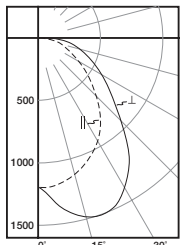

**24SR-LD2-39-C-UNV-L835-CD1-U**

Electronic Driver  
Linear LED 3500K  
Spacing criterion:  
(II) 1.2 x mounting  
height, (⊥) 1.5 x  
mounting height  
Lumens: 3997  
Input Watts: 31.9W  
Efficacy: 125.3 lm/W  
Test Report:  
24SR-LD2-39-C-UNV-  
L835-CD1-U.IES

**Candlepower**

| Angle | Along II | 45°  | Across ⊥ |
|-------|----------|------|----------|
| 0     | 1187     | 1187 | 1187     |
| 5     | 1186     | 1248 | 1301     |
| 10    | 1165     | 1330 | 1417     |
| 15    | 1130     | 1376 | 1479     |
| 20    | 1080     | 1382 | 1494     |
| 25    | 1019     | 1350 | 1462     |
| 30    | 939      | 1282 | 1375     |
| 35    | 847      | 1182 | 1247     |
| 40    | 746      | 1059 | 1096     |
| 45    | 639      | 931  | 939      |
| 50    | 533      | 811  | 794      |
| 55    | 439      | 701  | 667      |
| 60    | 351      | 607  | 567      |
| 65    | 279      | 523  | 478      |
| 70    | 213      | 443  | 404      |
| 75    | 157      | 365  | 331      |
| 80    | 105      | 279  | 234      |
| 85    | 56       | 162  | 130      |
| 90    | 0        | 0    | 0        |

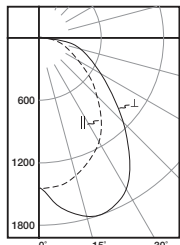

**24SR-LD2-48-C-UNV-L835-CD1-U**

Electronic Driver  
Linear LED 3500K  
Spacing criterion:  
(II) 1.2 x mounting  
height, (⊥) 1.5 x  
mounting height  
Lumens: 4805  
Input Watts: 38.2W  
Efficacy: 125.8 lm/W  
Test Report:  
24SR-LD2-48-C-UNV-  
L835-CD1-U.IES

**Candlepower**

| Angle | Along II | 45°  | Across ⊥ |
|-------|----------|------|----------|
| 0     | 1437     | 1437 | 1437     |
| 5     | 1438     | 1502 | 1565     |
| 10    | 1412     | 1599 | 1696     |
| 15    | 1370     | 1651 | 1774     |
| 20    | 1308     | 1660 | 1794     |
| 25    | 1231     | 1621 | 1757     |
| 30    | 1136     | 1538 | 1654     |
| 35    | 1030     | 1421 | 1506     |
| 40    | 905      | 1274 | 1320     |
| 45    | 774      | 1122 | 1127     |
| 50    | 647      | 972  | 952      |
| 55    | 529      | 844  | 801      |
| 60    | 425      | 727  | 676      |
| 65    | 334      | 627  | 573      |
| 70    | 256      | 530  | 483      |
| 75    | 186      | 437  | 397      |
| 80    | 125      | 335  | 282      |
| 85    | 65       | 194  | 153      |
| 90    | 0        | 0    | 0        |

**Coefficients of Utilization**

| rc<br>rw<br>RCR | Effective floor cavity reflectance |     |     |     |     |     |     |     |     |     |     |     |     |     |     |     |     |     |     |     |     |     |     |     |
|-----------------|------------------------------------|-----|-----|-----|-----|-----|-----|-----|-----|-----|-----|-----|-----|-----|-----|-----|-----|-----|-----|-----|-----|-----|-----|-----|
|                 | 80%                                |     |     |     | 70% |     |     |     | 50% |     |     |     | 30% |     |     |     | 10% |     |     |     | 0%  |     |     |     |
|                 | 70                                 | 50  | 30  | 10  | 70  | 50  | 30  | 10  | 50  | 30  | 10  | 50  | 30  | 10  | 50  | 30  | 10  | 50  | 30  | 10  | 50  | 30  | 10  | 0   |
| 0               | 119                                | 119 | 119 | 119 | 116 | 116 | 116 | 116 | 111 | 111 | 111 | 106 | 106 | 106 | 102 | 102 | 102 | 100 | 100 | 100 | 100 | 100 | 100 | 100 |
| 1               | 108                                | 103 | 98  | 94  | 105 | 101 | 96  | 93  | 96  | 93  | 90  | 92  | 89  | 87  | 89  | 86  | 84  | 82  | 82  | 82  | 82  | 82  | 82  | 82  |
| 2               | 98                                 | 89  | 82  | 76  | 95  | 87  | 81  | 75  | 84  | 78  | 74  | 81  | 76  | 72  | 78  | 74  | 70  | 68  | 68  | 68  | 68  | 68  | 68  | 68  |
| 3               | 89                                 | 78  | 70  | 63  | 87  | 77  | 69  | 63  | 74  | 67  | 62  | 71  | 65  | 61  | 68  | 64  | 60  | 57  | 57  | 57  | 57  | 57  | 57  | 57  |
| 4               | 82                                 | 70  | 61  | 54  | 79  | 68  | 60  | 53  | 66  | 58  | 53  | 63  | 57  | 52  | 61  | 56  | 51  | 49  | 49  | 49  | 49  | 49  | 49  | 49  |
| 5               | 75                                 | 62  | 53  | 46  | 73  | 61  | 53  | 46  | 59  | 51  | 46  | 57  | 50  | 45  | 55  | 49  | 45  | 42  | 42  | 42  | 42  | 42  | 42  | 42  |
| 6               | 70                                 | 56  | 47  | 41  | 68  | 55  | 47  | 40  | 53  | 46  | 40  | 52  | 45  | 40  | 50  | 44  | 39  | 37  | 37  | 37  | 37  | 37  | 37  | 37  |
| 7               | 65                                 | 51  | 42  | 36  | 63  | 50  | 42  | 36  | 49  | 41  | 35  | 47  | 40  | 35  | 46  | 40  | 35  | 33  | 33  | 33  | 33  | 33  | 33  | 33  |
| 8               | 60                                 | 47  | 38  | 32  | 59  | 46  | 38  | 32  | 44  | 37  | 32  | 43  | 36  | 32  | 42  | 36  | 31  | 29  | 29  | 29  | 29  | 29  | 29  | 29  |
| 9               | 56                                 | 43  | 34  | 29  | 55  | 42  | 34  | 29  | 41  | 34  | 29  | 40  | 33  | 28  | 39  | 33  | 28  | 26  | 26  | 26  | 26  | 26  | 26  | 26  |
| 10              | 53                                 | 39  | 31  | 26  | 51  | 39  | 31  | 26  | 38  | 31  | 26  | 37  | 30  | 26  | 36  | 30  | 26  | 24  | 24  | 24  | 24  | 24  | 24  | 24  |

**Zonal Lumen Summary**

| Zone  | Lumens | % Fixture |
|-------|--------|-----------|
| 0-30  | 1105   | 27.6      |
| 0-40  | 1810   | 45.3      |
| 0-60  | 3060   | 76.6      |
| 0-90  | 3997   | 100.0     |
| 0-180 | 3997   | 100.0     |

**Coefficients of Utilization**

| rc<br>rw<br>RCR | Effective floor cavity reflectance |     |     |     |     |     |     |     |     |     |     |     |     |     |     |     |     |     |     |     |     |     |     |     |
|-----------------|------------------------------------|-----|-----|-----|-----|-----|-----|-----|-----|-----|-----|-----|-----|-----|-----|-----|-----|-----|-----|-----|-----|-----|-----|-----|
|                 | 80%                                |     |     |     | 70% |     |     |     | 50% |     |     |     | 30% |     |     |     | 10% |     |     |     | 0%  |     |     |     |
|                 | 70                                 | 50  | 30  | 10  | 70  | 50  | 30  | 10  | 50  | 30  | 10  | 50  | 30  | 10  | 50  | 30  | 10  | 50  | 30  | 10  | 50  | 30  | 10  | 0   |
| 0               | 119                                | 119 | 119 | 119 | 116 | 116 | 116 | 116 | 111 | 111 | 111 | 106 | 106 | 106 | 102 | 102 | 102 | 100 | 100 | 100 | 100 | 100 | 100 | 100 |
| 1               | 108                                | 103 | 98  | 94  | 105 | 101 | 96  | 93  | 96  | 93  | 90  | 92  | 89  | 87  | 89  | 86  | 84  | 82  | 82  | 82  | 82  | 82  | 82  | 82  |
| 2               | 98                                 | 89  | 82  | 76  | 95  | 88  | 81  | 75  | 84  | 78  | 74  | 81  | 76  | 72  | 78  | 74  | 70  | 68  | 68  | 68  | 68  | 68  | 68  | 68  |
| 3               | 89                                 | 78  | 70  | 63  | 87  | 77  | 69  | 63  | 74  | 67  | 62  | 71  | 65  | 61  | 68  | 64  | 60  | 57  | 57  | 57  | 57  | 57  | 57  | 57  |
| 4               | 82                                 | 70  | 61  | 54  | 79  | 68  | 60  | 53  | 66  | 58  | 53  | 63  | 57  | 52  | 61  | 56  | 51  | 49  | 49  | 49  | 49  | 49  | 49  | 49  |
| 5               | 75                                 | 62  | 53  | 46  | 73  | 61  | 53  | 46  | 59  | 51  | 46  | 57  | 50  | 45  | 55  | 49  | 45  | 42  | 42  | 42  | 42  | 42  | 42  | 42  |
| 6               | 70                                 | 56  | 47  | 41  | 68  | 55  | 47  | 40  | 53  | 46  | 40  | 52  | 45  | 40  | 50  | 44  | 39  | 37  | 37  | 37  | 37  | 37  | 37  | 37  |
| 7               | 65                                 | 51  | 42  | 36  | 63  | 50  | 42  | 36  | 49  | 41  | 35  | 47  | 40  | 35  | 46  | 40  | 35  | 33  | 33  | 33  | 33  | 33  | 33  | 33  |
| 8               | 60                                 | 47  | 38  | 32  | 59  | 46  | 38  | 32  | 44  | 37  | 32  | 43  | 36  | 32  | 42  | 36  | 31  | 29  | 29  | 29  | 29  | 29  | 29  | 29  |
| 9               | 56                                 | 43  | 34  | 29  | 55  | 42  | 34  | 29  | 41  | 34  | 29  | 40  | 33  | 28  | 39  | 33  | 28  | 26  | 26  | 26  | 26  | 26  | 26  | 26  |
| 10              | 53                                 | 39  | 31  | 26  | 51  | 39  | 31  | 26  | 38  | 31  | 26  | 37  | 30  | 26  | 36  | 30  | 26  | 24  | 24  | 24  | 24  | 24  | 24  | 24  |

**Zonal Lumen Summary**

| Zone  | Lumens | % Fixture |
|-------|--------|-----------|
| 0-30  | 1328   | 27.6      |
| 0-40  | 2177   | 45.3      |
| 0-60  | 3680   | 76.6      |
| 0-90  | 4805   | 100.0     |
| 0-180 | 4805   | 100.0     |

## ENERGY AND PERFORMANCE DATA BY CATALOG NUMBER

| Stock or MTO* | Catalog Logic (Curved)       | Delivered Lumens | Watts | Efficacy (LPW) |
|---------------|------------------------------|------------------|-------|----------------|
| MTO           | 24SR-LD2-29-C-UNV-L830-CD1-U | 2840             | 22.7  | 125            |
| MTO           | 24SR-LD2-29-C-UNV-L835-CD1-U | 2928             | 22.7  | 129            |
| MTO           | 24SR-LD2-29-C-UNV-L840-CD1-U | 2987             | 22.7  | 132            |
| MTO           | 24SR-LD2-29-C-UNV-L850-CD1-U | 3250             | 22.7  | 143            |
| MTO           | 24SR-LD2-34-C-UNV-L830-CD1-U | 3360             | 27.2  | 124            |
| MTO           | 24SR-LD2-34-C-UNV-L835-CD1-U | 3464             | 27.2  | 127            |
| MTO           | 24SR-LD2-34-C-UNV-L840-CD1-U | 3533             | 27.2  | 130            |
| MTO           | 24SR-LD2-34-C-UNV-L850-CD1-U | 3845             | 27.2  | 141            |
| MTO           | 24SR-LD2-39-C-UNV-L830-CD1-U | 3877             | 31.9  | 122            |
| Stock         | 24SR-LD2-39-C-UNV-L835-CD1-U | 3997             | 31.9  | 125            |
| Stock         | 24SR-LD2-39-C-UNV-L840-CD1-U | 4077             | 31.9  | 128            |
| MTO           | 24SR-LD2-39-C-UNV-L850-CD1-U | 4437             | 31.9  | 139            |
| MTO           | 24SR-LD2-45-C-UNV-L830-CD1-U | 4377             | 36.7  | 119            |
| MTO           | 24SR-LD2-45-C-UNV-L835-CD1-U | 4512             | 36.7  | 123            |
| MTO           | 24SR-LD2-45-C-UNV-L840-CD1-U | 4602             | 36.7  | 125            |
| MTO           | 24SR-LD2-45-C-UNV-L850-CD1-U | 5008             | 36.7  | 136            |
| MTO           | 24SR-LD2-48-C-UNV-L830-CD1-U | 4661             | 38.2  | 122            |
| Stock         | 24SR-LD2-48-C-UNV-L835-CD1-U | 4805             | 38.2  | 126            |
| Stock         | 24SR-LD2-48-C-UNV-L840-CD1-U | 4901             | 38.2  | 128            |
| MTO           | 24SR-LD2-48-C-UNV-L850-CD1-U | 5334             | 38.2  | 140            |
| MTO           | 24SR-LD2-53-C-UNV-L830-CD1-U | 5158             | 43.1  | 120            |
| MTO           | 24SR-LD2-53-C-UNV-L835-CD1-U | 5318             | 43.1  | 123            |
| MTO           | 24SR-LD2-53-C-UNV-L840-CD1-U | 5424             | 43.1  | 126            |
| MTO           | 24SR-LD2-53-C-UNV-L850-CD1-U | 5903             | 43.1  | 137            |
| MTO           | 24SR-LD2-59-C-UNV-L830-CD1-U | 5739             | 50.2  | 114            |
| MTO           | 24SR-LD2-59-C-UNV-L835-CD1-U | 5917             | 50.2  | 118            |
| MTO           | 24SR-LD2-59-C-UNV-L840-CD1-U | 6035             | 50.2  | 120            |
| MTO           | 24SR-LD2-59-C-UNV-L850-CD1-U | 6568             | 50.2  | 131            |
| MTO           | 24SR-LD2-64-C-UNV-L830-CD1-U | 6284             | 55.5  | 113            |
| MTO           | 24SR-LD2-64-C-UNV-L835-CD1-U | 6478             | 55.5  | 117            |
| MTO           | 24SR-LD2-64-C-UNV-L840-CD1-U | 6608             | 55.5  | 119            |
| MTO           | 24SR-LD2-64-C-UNV-L850-CD1-U | 7191             | 55.5  | 130            |

\*Made to order (MTO) requires a typical two week lead time.

## ENERGY AND PERFORMANCE DATA BY CATALOG NUMBER

| Stock or MTO* | Catalog Logic (Straight)     | Delivered Lumens | Watts | Efficacy (LPW) |
|---------------|------------------------------|------------------|-------|----------------|
| MTO           | 24SR-LD2-29-S-UNV-L830-CD1-U | 2811             | 22.7  | 124            |
| MTO           | 24SR-LD2-29-S-UNV-L835-CD1-U | 2898             | 22.7  | 128            |
| MTO           | 24SR-LD2-29-S-UNV-L840-CD1-U | 2956             | 22.7  | 130            |
| MTO           | 24SR-LD2-29-S-UNV-L850-CD1-U | 3216             | 22.7  | 142            |
| MTO           | 24SR-LD2-34-S-UNV-L830-CD1-U | 3325             | 27.2  | 122            |
| MTO           | 24SR-LD2-34-S-UNV-L835-CD1-U | 3428             | 27.2  | 126            |
| MTO           | 24SR-LD2-34-S-UNV-L840-CD1-U | 3497             | 27.2  | 129            |
| MTO           | 24SR-LD2-34-S-UNV-L850-CD1-U | 3805             | 27.2  | 140            |
| MTO           | 24SR-LD2-39-S-UNV-L830-CD1-U | 3837             | 31.9  | 120            |
| MTO           | 24SR-LD2-39-S-UNV-L835-CD1-U | 3956             | 31.9  | 124            |
| MTO           | 24SR-LD2-39-S-UNV-L840-CD1-U | 4035             | 31.9  | 127            |
| MTO           | 24SR-LD2-39-S-UNV-L850-CD1-U | 4391             | 31.9  | 138            |
| MTO           | 24SR-LD2-45-S-UNV-L830-CD1-U | 4331             | 36.7  | 118            |
| MTO           | 24SR-LD2-45-S-UNV-L835-CD1-U | 4465             | 36.7  | 122            |
| MTO           | 24SR-LD2-45-S-UNV-L840-CD1-U | 4555             | 36.7  | 124            |
| MTO           | 24SR-LD2-45-S-UNV-L850-CD1-U | 4957             | 36.7  | 135            |
| MTO           | 24SR-LD2-48-S-UNV-L830-CD1-U | 4613             | 38.2  | 121            |
| MTO           | 24SR-LD2-48-S-UNV-L835-CD1-U | 4755             | 38.2  | 125            |
| MTO           | 24SR-LD2-48-S-UNV-L840-CD1-U | 4850             | 38.2  | 127            |
| MTO           | 24SR-LD2-48-S-UNV-L850-CD1-U | 5278             | 38.2  | 138            |
| MTO           | 24SR-LD2-53-S-UNV-L830-CD1-U | 5105             | 43.1  | 118            |
| MTO           | 24SR-LD2-53-S-UNV-L835-CD1-U | 5263             | 43.1  | 122            |
| MTO           | 24SR-LD2-53-S-UNV-L840-CD1-U | 5368             | 43.1  | 125            |
| MTO           | 24SR-LD2-53-S-UNV-L850-CD1-U | 5842             | 43.1  | 136            |
| MTO           | 24SR-LD2-59-S-UNV-L830-CD1-U | 5680             | 50.2  | 113            |
| MTO           | 24SR-LD2-59-S-UNV-L835-CD1-U | 5856             | 50.2  | 117            |
| MTO           | 24SR-LD2-59-S-UNV-L840-CD1-U | 5973             | 50.2  | 119            |
| MTO           | 24SR-LD2-59-S-UNV-L850-CD1-U | 6500             | 50.2  | 130            |
| MTO           | 24SR-LD2-64-S-UNV-L830-CD1-U | 6219             | 55.5  | 112            |
| MTO           | 24SR-LD2-64-S-UNV-L835-CD1-U | 6411             | 55.5  | 116            |
| MTO           | 24SR-LD2-64-S-UNV-L840-CD1-U | 6539             | 55.5  | 118            |
| MTO           | 24SR-LD2-64-S-UNV-L850-CD1-U | 7116             | 55.5  | 128            |

\*Made to order (MTO) requires a typical two week lead time.

## LUMEN MAINTENANCE

| Ambient Temperature | TM-21 Lumen Maintenance (100,000 hours) | Theoretical L70 (Hours) |
|---------------------|---|-------------------------|
| 25°C                | > 92%                                   | > 448,000               |

Non-IC data

## SKYTRIM FIELD INSTALLATION KITS

| Color Choice    | Kit Catalog Number | Kit Quantity |
|-----------------|--------------------|--------------|
| Tahitian Blue   | STK-4-TB-10PK      | 10           |
| Primary Green   | STK-4-PG-10PK      | 10           |
| Storaro Orange  | STK-4-SO-10PK      | 10           |
| Belladonna Rose | STK-4-BR-10PK      | 10           |
| Medium Red      | STK-4-MR-10PK      | 10           |
| Pearl           | STK-4-PL-10PK      | 10           |
| Straw           | STK-4-ST-10PK      | 10           |
| Custom Color    | STK-4-CC-*-10PK    | 10           |

\*Custom color requires Roscolux numeric specification color code, consult factory for more information.

**Note:** Chosen color will be matched on acrylic but will appear lighter once applied to lit light guide.

**ORDERING INFORMATION**

SAMPLE NUMBER: 24SR-LD2-48-C-UNV-L835-CD1-SVDP1-U

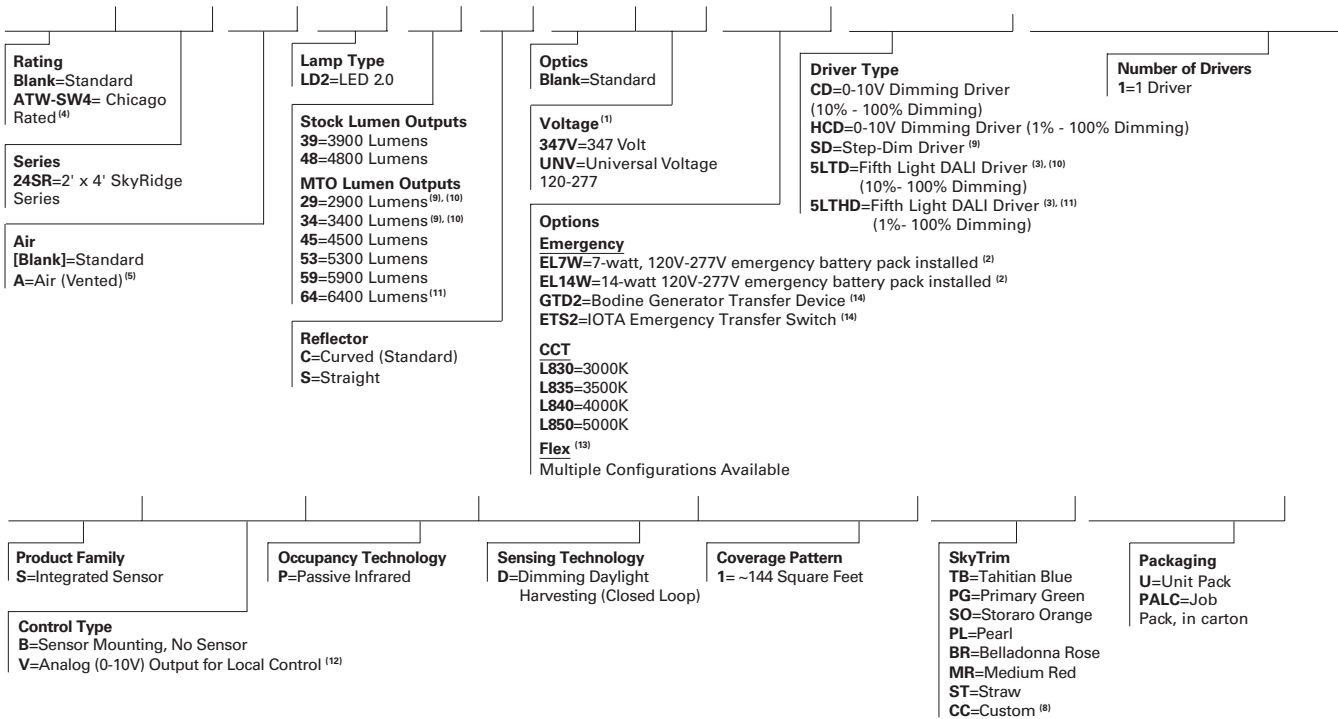

**ACCESSORIES**

- T3A END E.Q. BRACKET PARTS BAG (Standard with fixture)
- DF-24-W=2' x 4' Drywall Frame Kit
- SK-24-WT=2' x 4' Tall Surface Mount Kit
- DF10P-C\_=Decorator Dimmer, 0-10V
- SF10P-\_=Decorator Slide Dimmer, 0-10V
- ISHH-01=Programming Remote for Integrated Sensor
- ISHH-02=Personal Control Remote for Integrated Sensor

**NOTES:** <sup>(1)</sup>Products also available in non-US voltages and frequencies for international markets. <sup>(2)</sup>With integral test switch/indicator/laser test. For approximate delivered lumens multiply the lumens per watt of the desired fixture by the wattage of the emergency battery pack (100 lm/W x 7=700 lumens). IES-format photometry for luminaire under emergency operation available. <sup>(3)</sup>Must be used in conjunction with a DALI control system. For complete DALI solutions by Fifth Light, visit [www.coopercontrol.com](http://www.coopercontrol.com). <sup>(4)</sup>Chicago rated version does not allow for row mounting. <sup>(5)</sup>Air version is vented but does not meet air handling requirements. Air version is non-C. Air version is not available with integrated sensor. <sup>(8)</sup>Custom color must list Roscolux numeric color specification code. <sup>(9)</sup>2900 and 3400 lumen packages are not available with Step-Dim driver. <sup>(10)</sup>5LTD option is not available in 2900 and 3400 lumen packages. <sup>(11)</sup>5LTHD option uses two drivers at 6400 lumens. <sup>(12)</sup>Integral sensor works only with "CD" driver and is factory prewired to the driver for stand-alone control. <sup>(13)</sup>Flex does not include dimming leads. Control leads provided by others. <sup>(14)</sup>Used to transfer fixture to secondary power source for life-safety operation. When used with a dimming fixture, two devices are required to ensure control is disabled while operating under emergency power.

Specifications & dimensions subject to change without notice. Consult your Eaton Representative for availability and ordering information.

**SHIPPING DATA**

| Catalog No. | Wt.     |
|-------------|---------|
| 24SR-LD2-39 | 24 lbs. |
| 24SR-LD2-48 | 24 lbs. |

**INTEGRATED SENSOR**

The SkyRidge with Integrated Sensor technology provides automatic energy savings without sacrificing performance. Traditionally, these types of energy savings required coordination between the luminaire and a lighting control system. The SkyRidge delivers superior lighting with integrated occupancy and daylighting controls.

Capture the benefits of traditional lighting controls, without complicated coverage planning or special wiring. Ideal for new construction or retrofit, the SkyRidge delivers automatic ON to an energy saving light level, while ensuring lighting is turned OFF when the space is unoccupied.

The integral daylight sensor reduces the need for special daylight zone planning. Each luminaire will automatically adjust the light level based on reflected light beneath the sensor in a closed loop method.

Occupied daylight light levels and unoccupied light levels can be adjusted using the integrated sensor programming remote (Catalog Number: ISHH-01). The integrated sensor personal remote (Catalog Number: ISHH-02) provides code compliant manual raise, lower, ON, OFF control.

The SkyRidge with Integrated Sensor is easy to install with no special wiring and ensures energy savings out-of-the-box with default control settings.

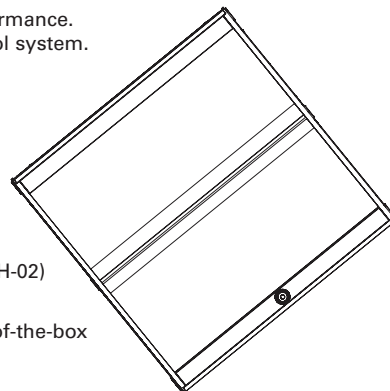

**How it works:**

- As the user enters the space controlled by the integral sensor, the lighting turns ON to the default daylight level.
- Lighting will remain at that the daylight level until the space is unoccupied. This will start the occupancy timeout period (default 20 minutes).
- If the space remains unoccupied for half of the timeout period, the lighting will automatically reduce to the Energy Saver light level. This adjustable light level is typically half of the occupied daylight level.
- At the end of the timeout period the lighting will go to the unoccupied light level. This adjustable light level uses the OFF default setting.

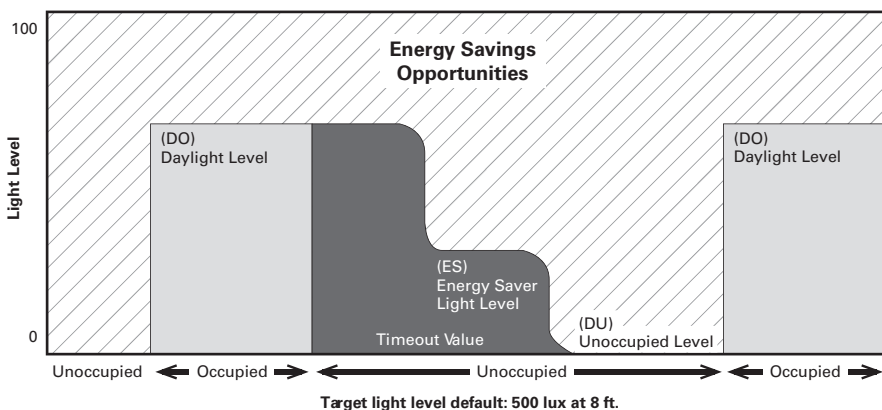

**Coverage**

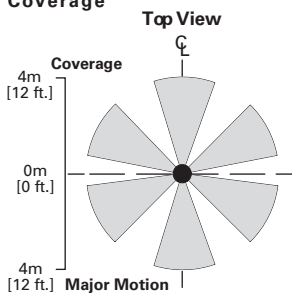

**Side View**

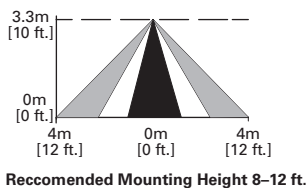

**Optional Remote Controls**



**ISHH-01 Programming Remote**



**ISHH-02 Personal Control Remote**