

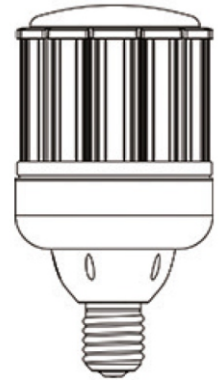

**Before You Begin**

# HID Retrofit Lamp User Manual



Read These Instructions Completely and Carefully

## **WARNING**

### **Risk of electric shock**

- Disconnect power from the luminaire and follow proper lockout/tagout procedures before installation or maintenance. Contact a qualified electrician for installation.
- These HID retrofit lamps require 100V-277V input voltage.
- These HID retrofit lamps require all ballasts, capacitors, and starters to be bypassed/removed.
- Suitable for use in dry or damp locations only. Do not use where directly exposed to liquid, vapor, rain.
- THIS DEVICE IS NOT INTENDED FOR USE WITH EMERGENCY EXITS.
- ADDED WEIGHT OF THE DEVICE MAY CAUSE INSTABILITY OF A FREE-STANDING PORTABLE LUMINAIRE.
- USE ONLY WITH A PORTABLE LUMINAIRE THAT IS PROVIDED WITH A SHADE.
- This device is not intended for use with dimmers or remote controls.
- This device is suitable for enclosed fixtures, however ensure that there is adequate space around the device for heat dissipation. 54W: ( 93 )D X ( 265 )H mm 80W-120W: ( 410 )D X ( 390 )H mm
- 27 Watt and above are only suitable for base-up & base-down (vertical) installation.

## Replacing Self Ballasted CFL Lamp

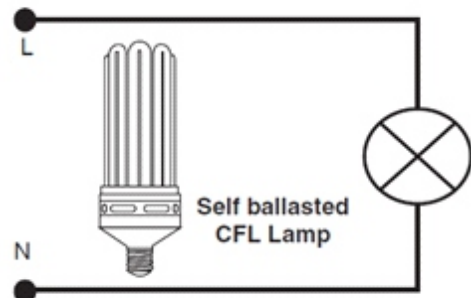

Self Ballasted CFL Wiring Diagram

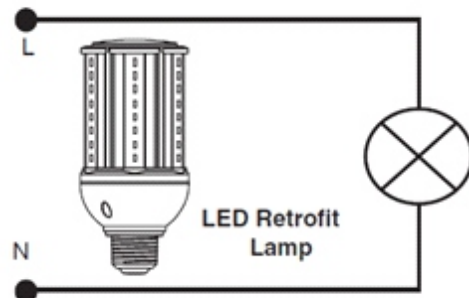
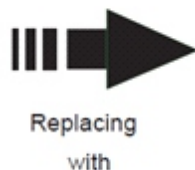

LED Retrofit Lamp Wiring Diagram

## Replacing HPS/HID Lamp

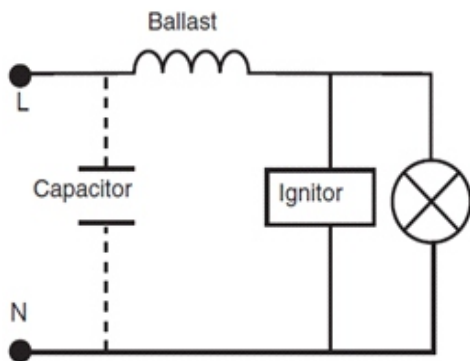

HPS/HID Wiring Diagram

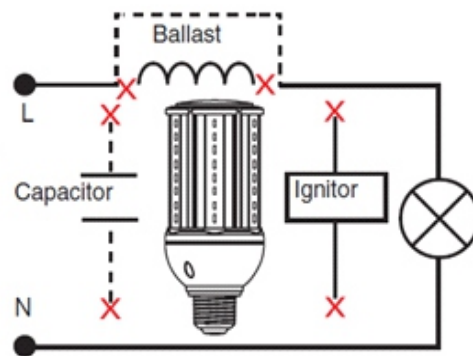
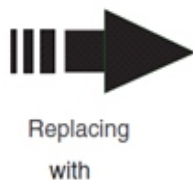

LED Retrofit Lamp Wiring Diagram