



AR111 6W

OUTPUT RANGE: VIVID SERIES	275 - 300 lumen
OUTPUT RANGE: BRILLIANT SERIES	355 - 380 lumen
BEAM ANGLE RANGE	4°
COLOR TEMPERATURE RANGE	2700K, 3000K
APPLICATION	Halogen replacement for indoor & outdoor applications



POINT SOURCE OPTICS

Exceptional beam control enables unique 4° narrow spot and smooth uniform beams

Single light source, single crisp shadow

VP₃ VIVID COLOR AND VP₃ NATURAL WHITE

VIVID series provides accurate color rendering across the visible spectrum from 400nm to 700nm, CRI-95, R9>95

Whiteness rendering matches or exceeds that of halogen and incandescent sources at 2700K and 3000K

ENERGY EFFICIENCY AND LONG LIFE

85% more energy efficient than standard halogen lamps

Typical payback of one year or less

Rated lifetime to L70: 35,000hrs

Warranty: 3yrs or 25,000hrs whichever comes first

Detailed warranty information available at sora.com/resources/legal

CERTIFICATIONS

UL/CUL Class 2 and non-Class 2, FCC Title 47 Part 15B, RoHS, CE



RoHS

HIGHLY COMPATIBLE

Narrow spot compatible with Soraa SNAP System accessories

Thermally and geometrically compatible with standard fixtures and suitable for damp locations

Suitable for fully enclosed fixtures. Can be used with front glass cover

Works with trailing edge and leading edge phase cut dimmers, 12V AC magnetic and electronic transformers and 12V DC transformers (see www.sora.com/resources)

INTENDED USE AND APPLICATIONS

Intended for use in AR111 compatible recessed downlights, track lighting and other indoor and outdoor applications

Soraa lamps are designed to safely turn down in any thermal environment not conducive to minimum airflow or proper ventilation

GENERAL SPECIFICATIONS

Form Factor	Operating Temperature	Electrical	Dimming and Flicker
Width: 111mm (4.37")	Minimum: -40°C (ambient)	Wattage: 6W	Dimmable to <20%
Height: 57mm (2.24")	Typical: 50°C - 60°C (base)	Power factor: 0.92	Flicker Index < 0.06
Weight: 250g	Maximum: 65°C (base)	Voltage: 12V +/- 1.2V	Percent Flicker: 22%
		Frequency: 50/60Hz	

DIMENSIONS

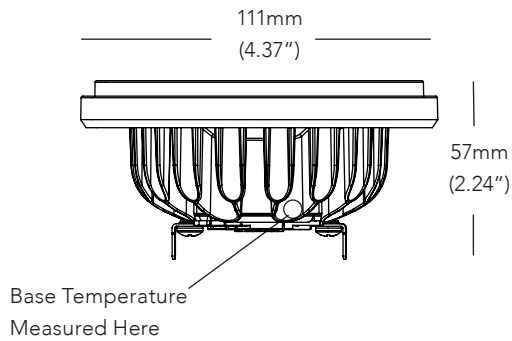

COLOR RENDERING

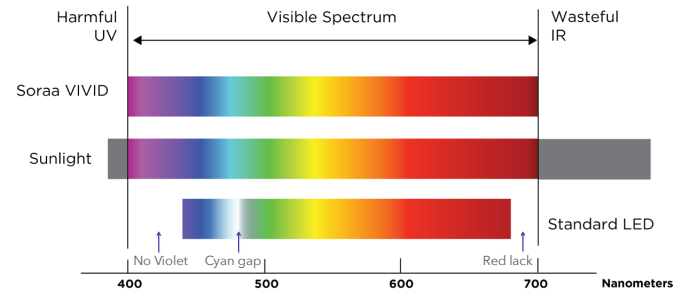

4 DEGREE BEAM

Beam Dia at 50% CBCP (ft)	Field Dia at 10% CBCP (ft)	Foot-candles (% of CBCP)
0.2	0.5	6.8%
0.4	0.9	2.3%
0.6	1.4	1.1%
0.8	1.9	0.7%
1.0	2.4	0.4%

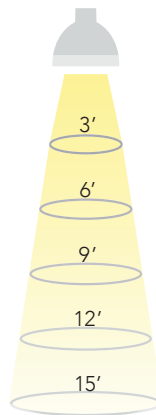

Note: Footcandles may be calculated by multiplying the CBCP of the desired model number by the percentage in the tables above

SPECIFICATIONS BY MODEL NUMBER* SORAA LED AR111 6W

Model #	Product Code	CCT (K)	Beam Angle	Field Angle	CBCP (Cd)	Halogen Equivalent	Total Flux (Lm)	Efficacy (Lm/W)	McA	SNAP
VIVID SERIES										
SR111-06-04D-927-03	01995	2700	4	9	11540	50	275	46	3	YES
SR111-06-04D-930-03	01997	3000	4	9	12600	50	300	50	3	YES
BRILLIANT SERIES										
SR111-06-04D-827-03	01991	2700	4	9	14900	60	355	59	3	YES
SR111-06-04D-830-03	01993	3000	4	9	15960	60	380	63	3	YES

CCT: Correlated Color Temperature **McA:** White Point Accuracy in McA step **SNAP:** SORAA SNAP System Compatible

*Specifications are at stable warm operating conditions (25°C ambient)

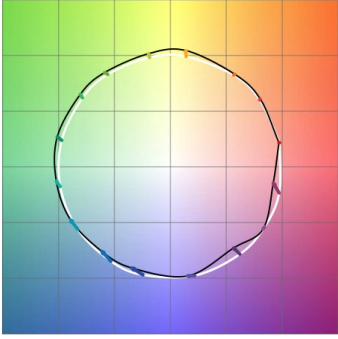
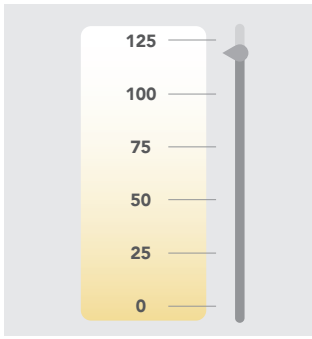
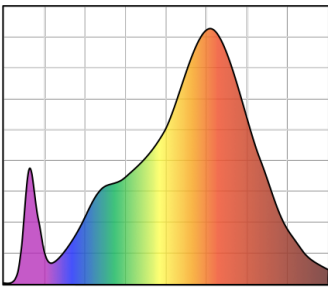
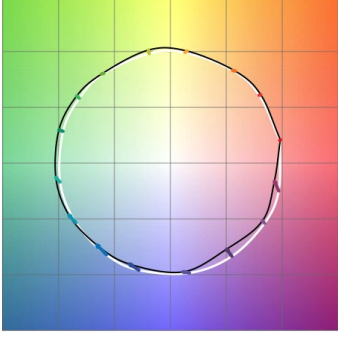
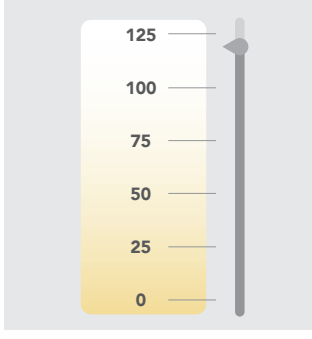
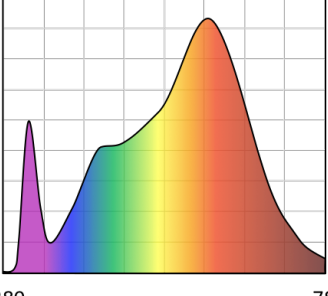
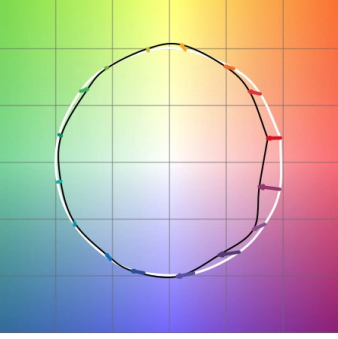
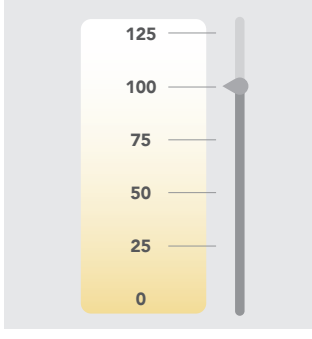
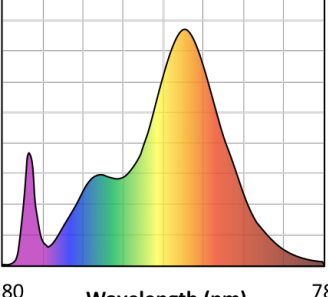
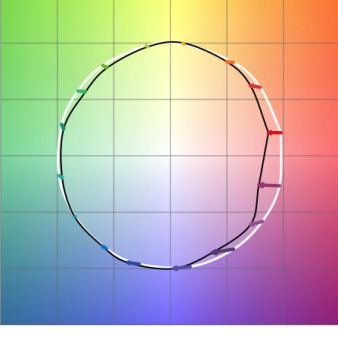
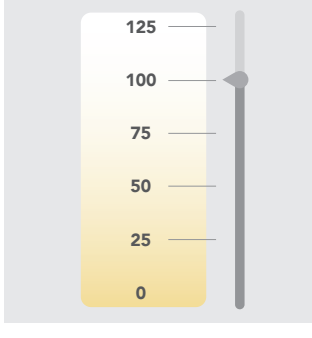
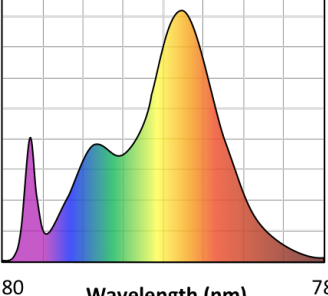
SERIES/CCT	COLOR ACCURACY	WHITENESS INDEX	SPECTRAL POWER DISTRIBUTION
VIVID 2700K	 Rf: 90, Rg: 100, Rfh1: 95	 Rw: 120	 CRI: 95, R9: 95
VIVID 3000K	 Rf: 90, Rg: 100, Rfh1: 95	 Rw: 120	 CRI: 95, R9: 95
BRILLIANT 2700K	 Rf: 85, Rg: 92, Rfh1: 77	 Rw: 100	 CRI: 85, R9: >0
BRILLIANT 3000K	 Rf: 85, Rg: 92, Rfh1: 77	 Rw: 100	 CRI: 85, R9: >0

Rf: TM-30 metric measuring color fidelity (whether colors are similar to those under natural light). Rf is a more accurate version of the CRI Ra. Rf is 100 for natural light.
Rg: TM-30 metric measuring color gamut (whether colors are more saturated than under natural light). Rg is 100 for natural light.
Rfh1: TM-30 metric measuring color fidelity for red tones. Rfh1 is a more accurate version of the CRI R9. Rfh1 is 100 for natural light.
Rw: Soraa-developed metric to measure white fidelity. Rw measures the magnitude of excitation of whitening agents within whites. Rw is about 100 for natural light.