

# PAR20 10.8W



<b>OUTPUT RANGE: VIVID SERIES</b>	500 - 560 lumen
<b>OUTPUT RANGE: BRILLIANT SERIES</b>	640 - 690 lumen
<b>BEAM ANGLE RANGE</b>	10°, 25°, 36°, 60°
<b>COLOR TEMPERATURE RANGE</b>	2700K, 3000K, 4000K
<b>APPLICATION</b>	Halogen replacement for indoor & outdoor applications



## POINT SOURCE OPTICS

Exceptional beam control enables unique 10° narrow spot and smooth uniform beams

Single light source, single crisp shadow

## VP<sub>3</sub> VIVID COLOR AND VP<sub>3</sub> NATURAL WHITE

VIVID series provides accurate color rendering across the visible spectrum from 400nm to 700nm, with CRI/95, R9/95, Rf/90, Rg/100

Whiteness rendering matches or exceeds that of halogen and incandescent sources at 2700K and 3000K

## ENERGY EFFICIENCY AND LONG LIFE

85% more energy efficient than standard halogen lamps

Typical payback of one year or less

Rated lifetime to L70: 35,000hrs

Warranty: 3yrs or 25,000hrs whichever comes first

Detailed warranty information available at [soraal.com/resources/legal](http://soraal.com/resources/legal)

## CERTIFICATIONS

JA8-2016-E, RoHS, CE, UL/CUL, FCC Title 47 Part 15B



## HIGHLY COMPATIBLE

Narrow spot compatible with Soraa SNAP System accessories

Thermally and geometrically compatible with standard fixtures and suitable for damp locations

Works with trailing edge and leading edge phase cut dimmers (see [www.soraal.com/resources](http://www.soraal.com/resources))

## INTENDED USE AND APPLICATIONS

Intended for use in PAR20 compatible recessed downlights, track lighting and other indoor and outdoor applications

Soraa lamps are designed to safely turn down in any thermal environment not conducive to minimum airflow or proper ventilation

## GENERAL SPECIFICATIONS

Form Factor	Operating Temperature	Electrical	Dimming and Flicker
Width: 64mm (2.52")	Minimum: -40°C (ambient)	Wattage: 10.8W	Dimmable to <20%
Height: 77mm (3.04")	Typical: 70°C - 80°C (base)	Power factor: 0.92	Flicker Index: <0.10
Weight: 160g	Maximum: 90°C (base)	Voltage: 120V +/- 12V	Percent Flicker: 23%*
		Frequency: 50/60Hz	

\* These Soraa lamps are certified to California's demanding JA8 standard, which requires <30% flicker

## DIMENSIONS

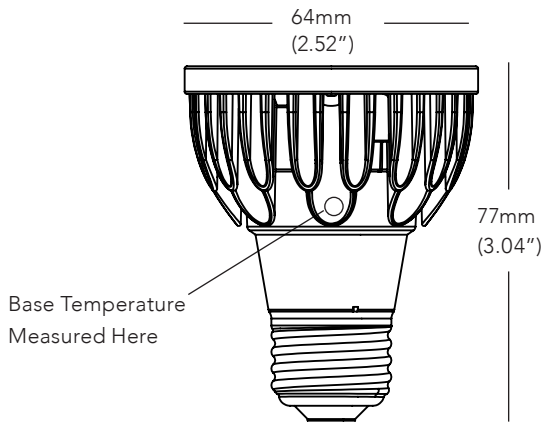

## COLOR RENDERING

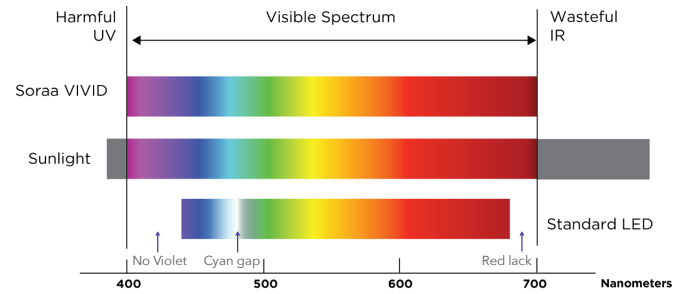

## 10 DEGREE BEAM

Beam Dia at 50% CBCP (ft)	Field Dia at 10% CBCP (ft)	Foot-candles (% of CBCP)
0.5	1.1	11.1%
1.0	2.1	2.8%
1.6	3.2	1.2%
2.1	4.2	0.7%
2.6	5.3	0.4%

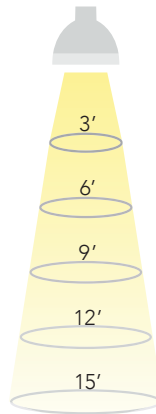

## 25 DEGREE BEAM

Beam Dia at 50% CBCP (ft)	Field Dia at 10% CBCP (ft)	Foot-candles (% of CBCP)
1.3	2.2	11.1%
2.7	4.4	2.8%
4.0	6.6	1.2%
5.3	8.7	0.7%
6.7	10.9	0.4%

## 60 DEGREE BEAM

Beam Dia at 50% CBCP (ft)	Field Dia at 10% CBCP (ft)	Foot-candles (% of CBCP)
1.9	3.5	11.1%
3.9	6.9	2.8%
5.8	10.4	1.2%
7.8	13.9	0.7%
9.7	17.3	0.4%

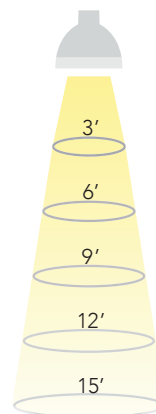

Beam Dia at 50% CBCP (ft)	Field Dia at 10% CBCP (ft)	Foot-candles (% of CBCP)
3.5	6.0	11.1%
6.9	12.0	2.8%
10.4	18.0	1.2%
13.9	24.0	0.7%
17.3	30.0	0.4%

Note: Footcandles may be calculated by multiplying the CBCP of the desired model number by the percentage in the tables above

## SPECIFICATIONS BY MODEL NUMBER\* SORAA LED PAR20 10.8W

Model #	Product Code	CCT (K)	Beam Angle	Field Angle	CBCP (Cd)	Halogen Equivalent	Total Flux (Lm)	Efficacy (Lm/W)	McA	JA8-2016-E	SNAP
<b>VIVID SERIES</b>											
SP20-11-10D-927-03	01599	2700	10	20	8000	75	500	46	3	YES	YES
SP20-11-25D-927-03	01601	2700	25	40	2640	75	500	46	3	YES	-
SP20-11-36D-927-03	01603	2700	36	60	1240	75	500	46	3	YES	-
SP20-11-60D-927-03	01605	2700	60	90	540	75	500	46	3	YES	-
SP20-11-10D-930-03	01615	3000	10	20	8640	75	540	50	3	YES	YES
SP20-11-25D-930-03	01617	3000	25	40	2860	75	540	50	3	YES	-
SP20-11-36D-930-03	01619	3000	36	60	1340	75	540	50	3	YES	-
SP20-11-60D-930-03	01621	3000	60	90	580	75	540	50	3	YES	-
SP20-11-10D-940-03	01631	4000	10	20	8960	75	560	52	4	NA	YES
SP20-11-25D-940-03	01633	4000	25	40	2960	75	560	52	4	NA	-
SP20-11-36D-940-03	01635	4000	36	60	1400	75	560	52	4	NA	-
SP20-11-60D-940-03	01637	4000	60	90	600	75	560	52	4	NA	-
<b>BRILLIANT SERIES</b>											
SP20-11-10D-827-03	01607	2700	10	20	10240	90	640	59	3	NA	YES
SP20-11-25D-827-03	01609	2700	25	40	3380	90	640	59	3	NA	-
SP20-11-36D-827-03	01611	2700	36	60	1600	90	640	59	3	NA	-
SP20-11-60D-827-03	01613	2700	60	90	700	90	640	59	3	NA	-
SP20-11-10D-830-03	01623	3000	10	20	11040	90	690	64	3	NA	YES
SP20-11-25D-830-03	01625	3000	25	40	3640	90	690	64	3	NA	-
SP20-11-36D-830-03	01627	3000	36	60	1720	90	690	64	3	NA	-
SP20-11-60D-830-03	01629	3000	60	90	740	90	690	64	3	NA	-

**CCT:** Correlated Color Temperature **McA:** White Point Accuracy in McA step **SNAP:** SORAA SNAP System Compatible

\*Specifications are at stable warm operating conditions (25°C ambient)

**SERIES/CCT**

**COLOR ACCURACY**

**WHITENESS INDEX**

**SPECTRAL POWER DISTRIBUTION**

**VIVID  
2700K**

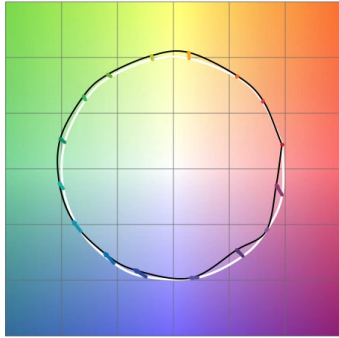

Rf: 90, Rg: 100, Rfh1: 95

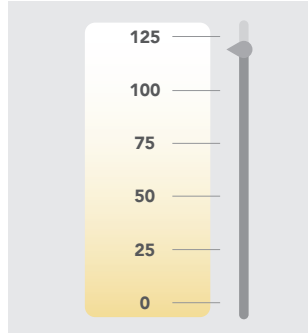

Rw: 120

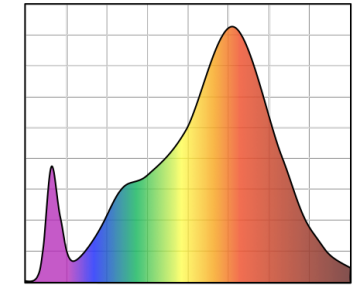

380 Wavelength (nm) 780

CRI: 95, R9: 95

**VIVID  
3000K**

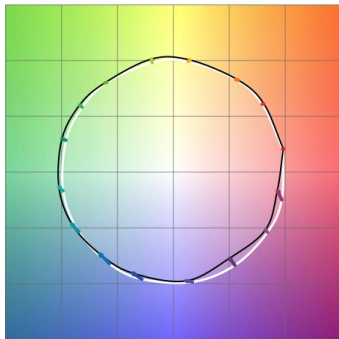

Rf: 90, Rg: 100, Rfh1: 95

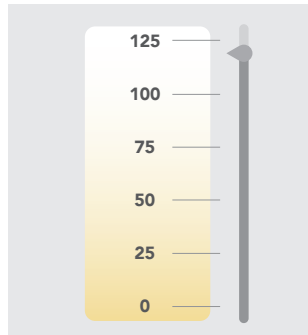

Rw: 120

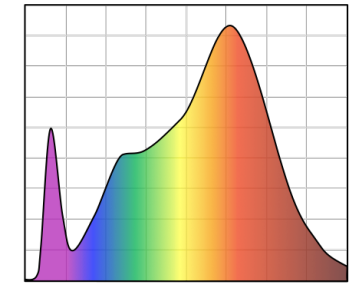

380 Wavelength (nm) 780

CRI: 95, R9: 95

**VIVID  
4000K**

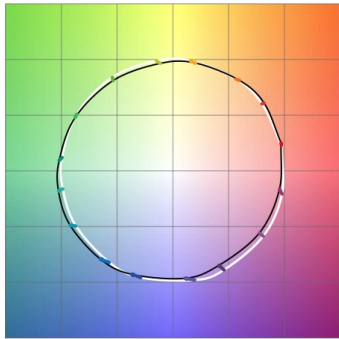

Rf: 90, Rg: 100, Rfh1: 95

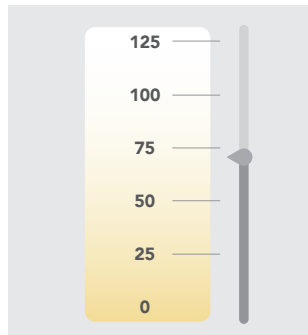

Rw: 70

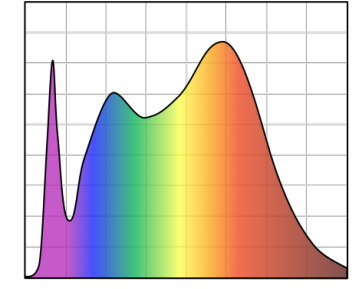

380 Wavelength (nm) 780

CRI: 95, R9: 95

**SERIES/CCT**

**COLOR ACCURACY**

**WHITENESS INDEX**

**SPECTRAL POWER DISTRIBUTION**

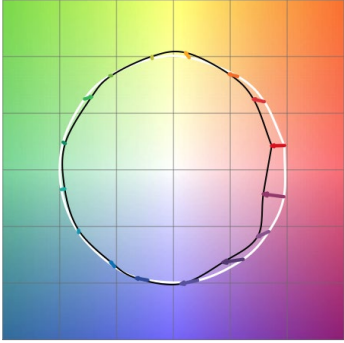
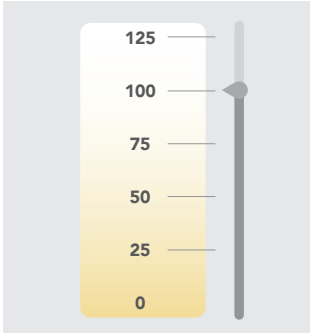
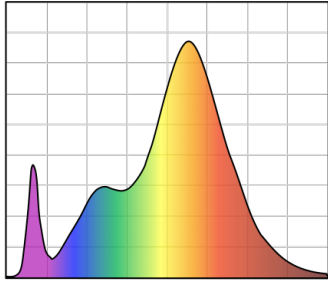
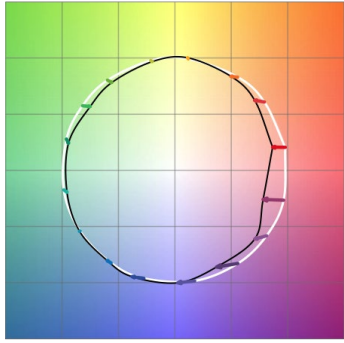
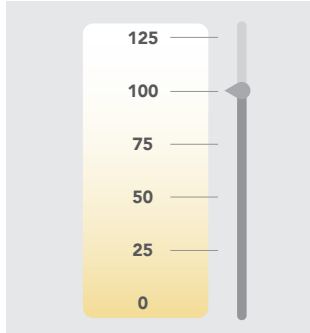
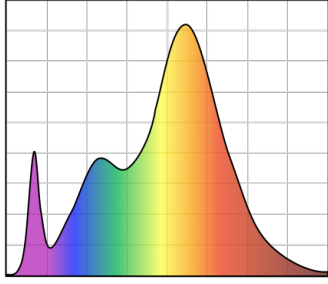
<p><b>BRILLIANT 2700K</b></p>	 <p><b>Rf: 85, Rg: 92, Rfh1: 77</b></p>	 <p><b>Rw: 100</b></p>	 <p><b>380 Wavelength (nm) 780</b></p> <p><b>CRI: 85, R9: &gt;0</b></p>
<p><b>BRILLIANT 3000K</b></p>	 <p><b>Rf: 85, Rg: 92, Rfh1: 77</b></p>	 <p><b>Rw: 100</b></p>	 <p><b>380 Wavelength (nm) 780</b></p> <p><b>CRI: 85, R9: &gt;0</b></p>

Rf: TM-30 metric measuring color fidelity (whether colors are similar to those under natural light). Rf is a more accurate version of the CRI Ra. Rf is 100 for natural light.  
 Rg: TM-30 metric measuring color gamut (whether colors are more saturated than under natural light). Rg is 100 for natural light.  
 Rfh1: TM-30 metric measuring color fidelity for red tones. Rfh1 is a more accurate version of the CRI R9. Rfh1 is 100 for natural light.  
 Rw: Soraa-developed metric to measure white fidelity. Rw measures the magnitude of excitation of whitening agents within whites. Rw is about 100 for natural light.