

MR16-GU10 7.5W



OUTPUT RANGE: VIVID SERIES 390 - 455 lumen

OUTPUT RANGE: BRILLIANT SERIES 475 - 525 lumen

BEAM ANGLE RANGE 10°, 25°, 36°, 60°

COLOR TEMPERATURE RANGE 2700K, 3000K, 4000K

APPLICATION Halogen replacement for indoor & outdoor applications



120V



GU10



DIM



POINT SOURCE OPTICS

Exceptional beam control enables unique 10° narrow spot and smooth uniform beams

Single light source, single crisp shadow

VP₃ VIVID COLOR AND VP₃ NATURAL WHITE

VIVID series provides accurate color rendering across the visible spectrum from 400nm to 700nm, with CRI/95, R9/95, Rf/90, Rg/100

Whiteness rendering matches or exceeds that of halogen and incandescent sources at 2700K and 3000K

ENERGY EFFICIENCY AND LONG LIFE

85% more energy efficient than standard halogen lamps

Typical payback of one year or less

Rated lifetime to L70: 35,000hrs

Warranty: 3yrs or 25,000hrs whichever comes first

Detailed warranty information available at soraa.com/resources/legal

CERTIFICATIONS

UL/CUL, FCC Title 47 Part 15B, RoHS



RoHS

HIGHLY COMPATIBLE

Narrow spot compatible with Soraa SNAP System accessories

Geometrically compatible with standard fixtures and suitable for damp locations

This lamp is suitable for use in fully enclosed fixtures, subject to the maximum heatsink temperature limits stated in this data sheet. A list of qualified enclosed fixtures can be found at www.soraa.com/resources

Works with trailing edge and leading edge phase cut dimmers (see www.soraa.com/resources)

INTENDED USE AND APPLICATIONS

Intended for use in GU10 compatible recessed downlights, track lighting and other indoor and outdoor applications

Soraa lamps are designed to safely turn down in any thermal environment not conducive to minimum airflow or proper ventilation

GENERAL SPECIFICATIONS

Form Factor

Width: 49.9mm (1.96")

Height: 53.5mm (2.10")

Weight: 61g

Operating Temperature

Minimum: -40°C (ambient)

Typical: 85°C - 95°C (base)

Maximum: 100°C (base)

Electrical

Wattage: 7.5W

Power factor: 0.93

Voltage: 120V +/- 12V

Frequency: 50/60Hz

Dimming and Flicker

Dimmable to <20%

Flicker Index: <0.12

Percent Flicker: 40%

DIMENSIONS

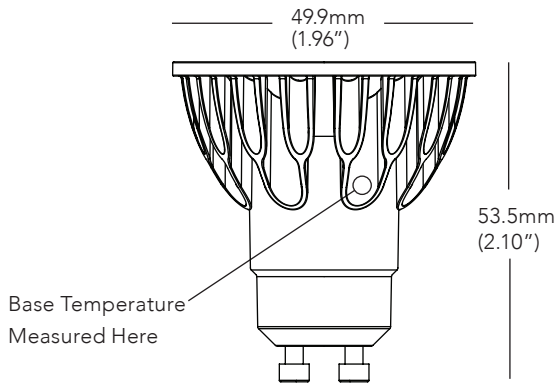

COLOR RENDERING

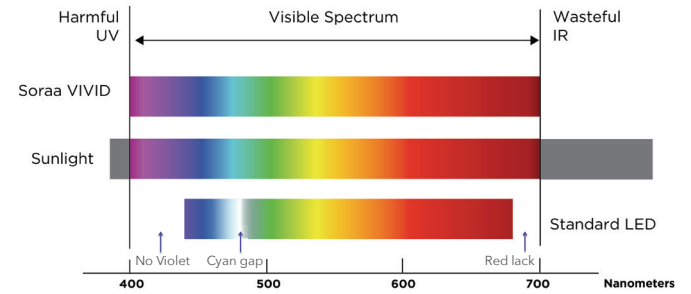

10 DEGREE BEAM

Beam Dia at 50% CBCP (ft)	Field Dia at 10% CBCP (ft)	Foot-candles (% of CBCP)
0.5	1.1	11.1%
1.0	2.1	2.8%
1.6	3.2	1.2%
2.1	4.2	0.7%
2.6	5.3	0.4%

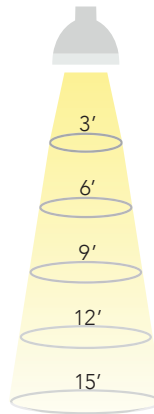

25 DEGREE BEAM

Beam Dia at 50% CBCP (ft)	Field Dia at 10% CBCP (ft)	Foot-candles (% of CBCP)
1.3	2.1	11.1%
2.7	4.1	2.8%
4.0	6.2	1.2%
5.3	8.3	0.7%
6.7	10.3	0.4%

60 DEGREE BEAM

36 DEGREE BEAM

Beam Dia at 50% CBCP (ft)	Field Dia at 10% CBCP (ft)	Foot-candles (% of CBCP)
1.9	3.1	11.1%
3.9	6.1	2.8%
5.8	9.2	1.2%
7.8	12.2	0.7%
9.7	15.3	0.4%

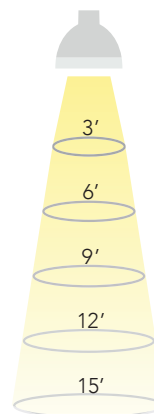

Beam Dia at 50% CBCP (ft)	Field Dia at 10% CBCP (ft)	Foot-candles (% of CBCP)
3.5	5.4	11.1%
6.9	10.8	2.8%
10.4	16.2	1.2%
13.9	21.6	0.7%
17.3	27.0	0.4%

Note: Footcandles may be calculated by multiplying the CBCP of the desired model number by the percentage in the tables above

SPECIFICATIONS BY MODEL NUMBER* SORAA LED MR16-GU10 7.5W

Model #	Product Code	CCT (K)	Beam Angle	Field Angle	CBCP (Cd)	Halogen Equivalent	Total Flux (Lm)	Efficacy (Lm/W)	McA	SNAP
VIVID SERIES										
SM16GA-07-10D-927-03	01111	2700	10	17	5710	50	390	52	3	YES
SM16GA-07-25D-927-03	01123	2700	25	38	2260	50	410	55	3	-
SM16GA-07-36D-927-03	01135	2700	36	54	1070	50	410	55	3	-
SM16GA-07-60D-927-03	01573	2700	60	84	420	50	410	55	3	-
SM16GA-07-10D-930-03	01115	3000	10	17	6000	50	410	55	3	YES
SM16GA-07-25D-930-03	01127	3000	25	38	2400	50	435	58	3	-
SM16GA-07-36D-930-03	01139	3000	36	54	1130	50	435	58	3	-
SM16GA-07-60D-930-03	01577	3000	60	84	440	50	435	58	3	-
SM16GA-07-10D-940-03	01117	4000	10	17	6290	50	430	57	4	YES
SM16GA-07-25D-940-03	01129	4000	25	38	2510	50	455	61	4	-
SM16GA-07-36D-940-03	01141	4000	36	54	1190	50	455	61	4	-
SM16GA-07-60D-940-03	01579	4000	60	84	460	50	455	61	4	-
BRILLIANT SERIES										
SM16GA-07-10D-827-03	01109	2700	10	17	6950	65	475	63	3	YES
SM16GA-07-25D-827-03	01121	2700	25	38	2760	65	500	67	3	-
SM16GA-07-36D-827-03	01133	2700	36	54	1310	65	500	67	3	-
SM16GA-07-60D-827-03	01571	2700	60	84	510	65	500	67	3	-
SM16GA-07-10D-830-03	01113	3000	10	17	7320	65	500	67	3	YES
SM16GA-07-25D-830-03	01125	3000	25	38	2900	65	525	70	3	-
SM16GA-07-36D-830-03	01137	3000	36	54	1370	65	525	70	3	-
SM16GA-07-60D-830-03	01575	3000	60	84	540	65	525	70	3	-

CCT: Correlated Color Temperature **McA:** White Point Accuracy in McA step **SNAP:** SORAA SNAP System Compatible

*Specifications are at stable warm operating conditions (25°C ambient)

SERIES/CCT

COLOR ACCURACY

WHITENESS INDEX

SPECTRAL POWER DISTRIBUTION

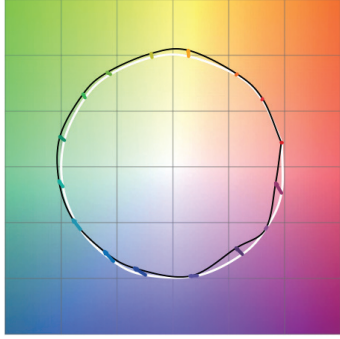
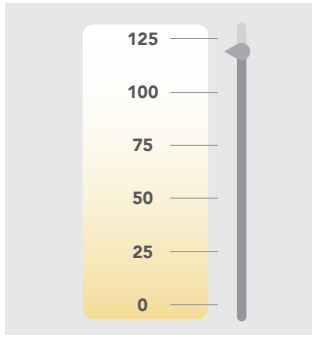
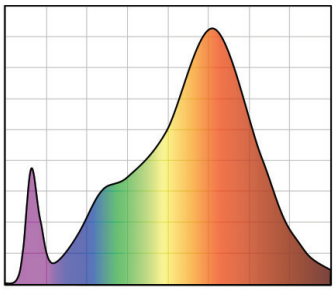
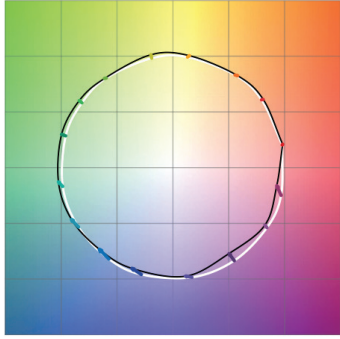
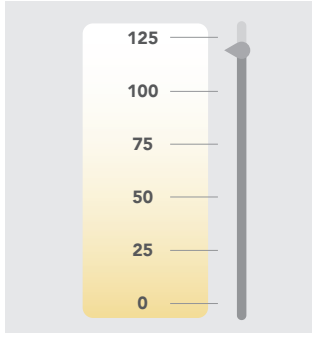
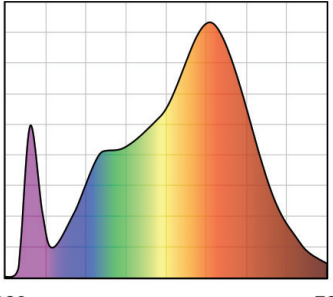
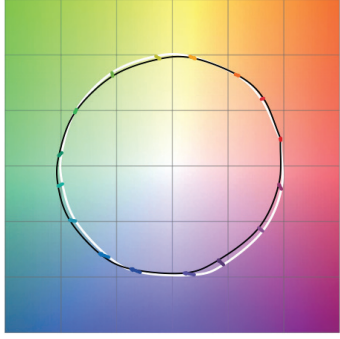
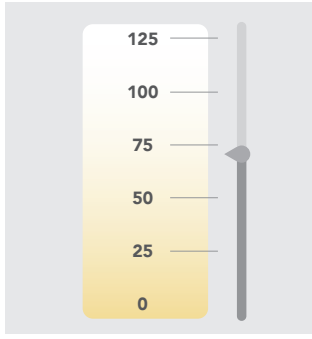
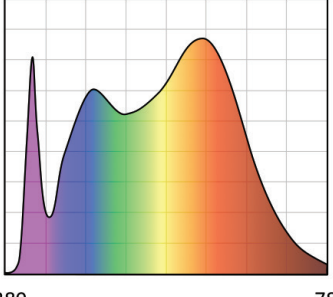
<p>VIVID 2700K</p>	 <p>Rf: 90, Rg: 100, Rfh1: 95</p>	 <p>Rw: 120</p>	 <p>380 Wavelength (nm) 780</p> <p>CRI: 95, R9: 95</p>
<p>VIVID 3000K</p>	 <p>Rf: 90, Rg: 100, Rfh1: 95</p>	 <p>Rw: 120</p>	 <p>380 Wavelength (nm) 780</p> <p>CRI: 95, R9: 95</p>
<p>VIVID 4000K</p>	 <p>Rf: 90, Rg: 100, Rfh1: 95</p>	 <p>Rw: 70</p>	 <p>380 Wavelength (nm) 780</p> <p>CRI: 95, R9: 95</p>

SERIES/CCT

COLOR ACCURACY

WHITENESS INDEX

SPECTRAL POWER DISTRIBUTION

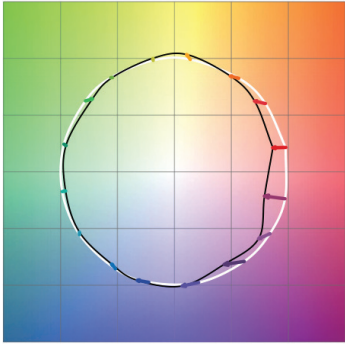
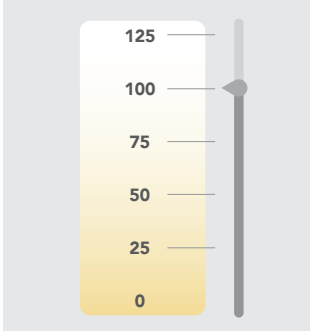
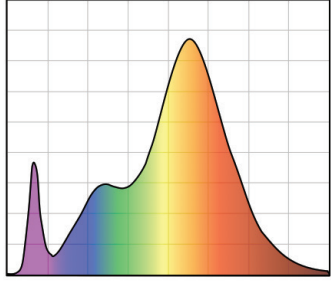
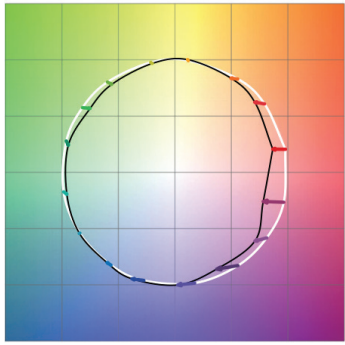
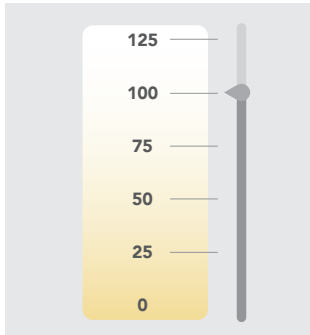
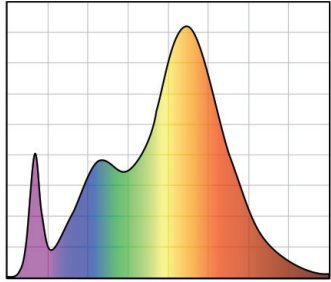
<p>BRILLIANT 2700K</p>	 <p>Rf: 85, Rg: 92, Rfh1: 77</p>	 <p>Rw: 100</p>	 <p>Wavelength (nm) 380 780</p> <p>CRI: 85, R9: >0</p>
<p>BRILLIANT 3000K</p>	 <p>Rf: 85, Rg: 92, Rfh1: 77</p>	 <p>Rw: 100</p>	 <p>Wavelength (nm) 380 780</p> <p>CRI: 85, R9: >0</p>

Rf: TM-30 metric measuring color fidelity (whether colors are similar to those under natural light). Rf is a more accurate version of the CRI Ra. Rf is 100 for natural light.
 Rg: TM-30 metric measuring color gamut (whether colors are more saturated than under natural light). Rg is 100 for natural light.
 Rfh1: TM-30 metric measuring color fidelity for red tones. Rfh1 is a more accurate version of the CRI R9. Rfh1 is 100 for natural light.
 Rw: Soraa-developed metric to measure white fidelity. Rw measures the magnitude of excitation of whitening agents within whites. Rw is about 100 for natural light.