



AR111 12.5W

OUTPUT RANGE: VIVID SERIES	575 - 645 lumen
OUTPUT RANGE: BRILLIANT SERIES	735 - 795 lumen
BEAM ANGLE RANGE	8°, 25°, 36°
COLOR TEMPERATURE RANGE	2700K, 3000K, 4000K
APPLICATION	Halogen replacement for indoor & outdoor applications



POINT SOURCE OPTICS

Exceptional beam control enables unique 8° narrow spot and smooth uniform beams

Single light source, single crisp shadow

VP₃ VIVID COLOR AND VP₃ NATURAL WHITE

VIVID series provides accurate color rendering across the visible spectrum from 400nm to 700nm, with CRI/95, R9/95, Rf/90, Rg/100

Whiteness rendering matches or exceeds that of halogen and incandescent sources at 2700K and 3000K

ENERGY EFFICIENCY AND LONG LIFE

85% more energy efficient than standard halogen lamps

Typical payback of one year or less

Rated lifetime to L70: 35,000hrs

Warranty: 3yrs or 25,000hrs whichever comes first

Detailed warranty information available at sora.com/resources/legal

CERTIFICATIONS

UL/CUL Class 2 and non-Class 2, FCC Title 47 Part 15B, RoHS, CE



RoHS

HIGHLY COMPATIBLE

Narrow spot compatible with Soraa SNAP System accessories

Thermally and geometrically compatible with standard fixtures and suitable for damp locations

Suitable for fully enclosed fixtures. Can be used with front glass cover

Works with trailing edge and leading edge phase cut dimmers, 12V AC magnetic and electronic transformers and 12V DC transformers (see www.sora.com/resources)

INTENDED USE AND APPLICATIONS

Intended for use in AR111 compatible recessed downlights, track lighting and other indoor and outdoor applications

Soraa lamps are designed to safely turn down in any thermal environment not conducive to minimum airflow or proper ventilation

GENERAL SPECIFICATIONS

Form Factor	Operating Temperature	Electrical	Dimming and Flicker
Width: 111mm (4.37")	Minimum: -40°C (ambient)	Wattage: 12.5W	Dimmable to <20%
Height: 57mm (2.24")	Typical: 60°C - 70°C (base)	Power factor: 0.92	Flicker Index < 0.1
Weight: 250g	Maximum: 80°C (base)	Voltage: 12V +/- 1.2V	Percent Flicker: 28%
		Frequency: 50/60Hz	

DIMENSIONS

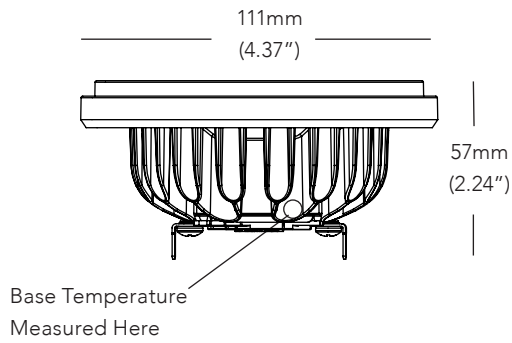

COLOR RENDERING

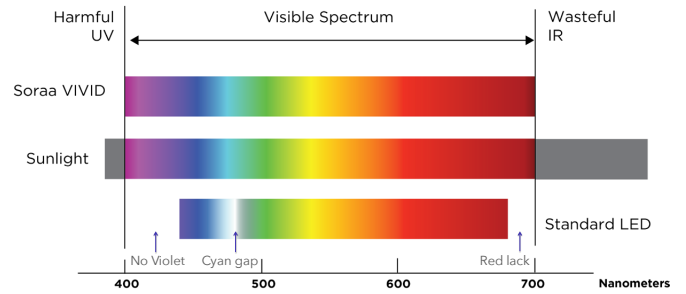

8 DEGREE BEAM

Beam Dia at 50% CBCP (ft)	Field Dia at 10% CBCP (ft)	Foot-candles (% of CBCP)
0.4	0.7	6.8%
0.8	1.5	2.3%
1.3	2.2	1.1%
1.7	2.9	0.7%
2.1	3.7	0.4%

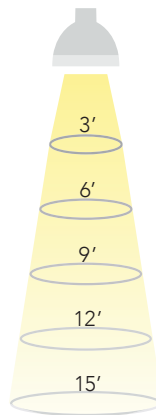

25 DEGREE BEAM

Beam Dia at 50% CBCP (ft)	Field Dia at 10% CBCP (ft)	Foot-candles (% of CBCP)
1.3	2.2	6.8%
2.7	4.4	2.3%
4.0	6.6	1.1%
5.3	8.7	0.7%
6.7	10.9	0.4%

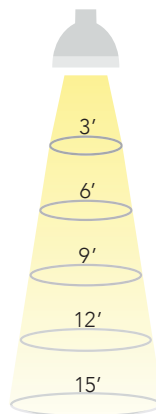

36 DEGREE BEAM

Beam Dia at 50% CBCP (ft)	Field Dia at 10% CBCP (ft)	Foot-candles (% of CBCP)
1.9	3.5	6.8%
3.9	6.9	2.3%
5.8	10.4	1.1%
7.8	13.9	0.7%
9.7	17.3	0.4%

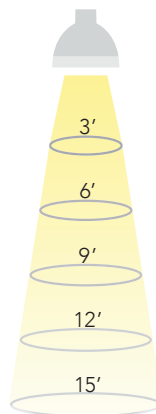

Note: Footcandles may be calculated by multiplying the CBCP of the desired model number by the percentage in the tables above

SPECIFICATIONS BY MODEL NUMBER* SORAA LED AR111 12.5W

Model #	Product Code	CCT (K)	Beam Angle	Field Angle	CBCP (Cd)	Halogen Equivalent	Total Flux (Lm)	Efficacy (Lm/W)	McA	SNAP
VIVID SERIES										
SR111-12-08D-927-03	01379	2700	8	14	15520	50	575	46	3	YES
SR111-12-25D-927-03	01381	2700	25	40	3100	50	575	46	3	-
SR111-12-36D-927-03	01383	2700	36	60	1420	50	575	46	3	-
SR111-12-08D-930-03	01395	3000	8	14	16740	50	620	50	3	YES
SR111-12-25D-930-03	01397	3000	25	40	3340	50	620	50	3	-
SR111-12-36D-930-03	01399	3000	36	60	1540	50	620	50	3	-
SR111-12-08D-940-03	01411	4000	8	14	17400	50	645	52	4	YES
SR111-12-25D-940-03	01413	4000	25	40	3480	50	645	52	4	-
SR111-12-36D-940-03	01415	4000	36	60	1600	50	645	52	4	-
BRILLIANT SERIES										
SR111-12-08D-827-03	01387	2700	8	14	19840	60	735	59	3	YES
SR111-12-25D-827-03	01389	2700	25	40	3960	60	735	59	3	-
SR111-12-36D-827-03	01391	2700	36	60	1820	60	735	59	3	-
SR111-12-08D-830-03	01403	3000	8	14	21460	60	795	64	3	YES
SR111-12-25D-830-03	01405	3000	25	40	4280	60	795	64	3	-
SR111-12-36D-830-03	01407	3000	36	60	1980	60	795	64	3	-

CCT: Correlated Color Temperature **McA:** White Point Accuracy in McA step **SNAP:** SORAA SNAP System Compatible

*Specifications are at stable warm operating conditions (25°C ambient)

SERIES/CCT

COLOR ACCURACY

WHITENESS INDEX

SPECTRAL POWER DISTRIBUTION

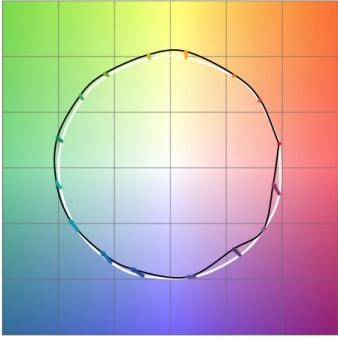
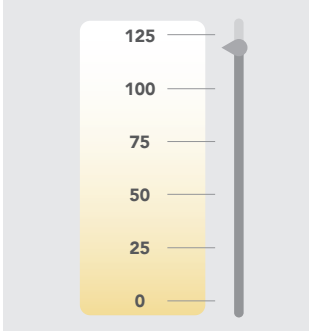
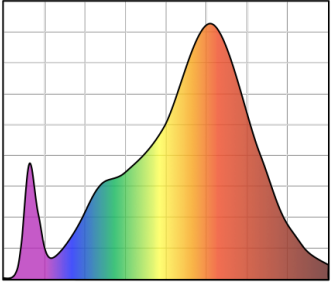
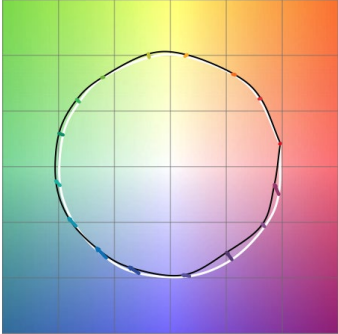
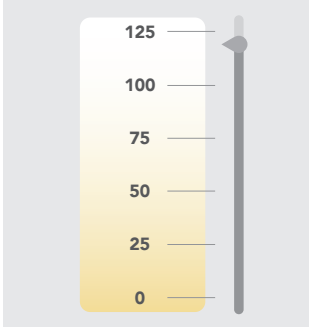
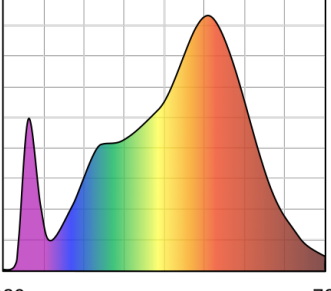
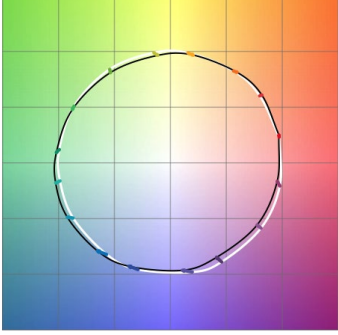
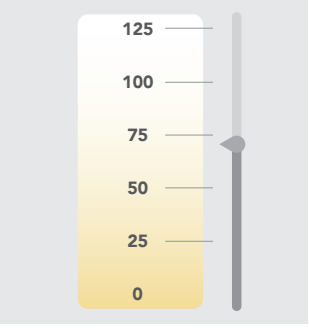
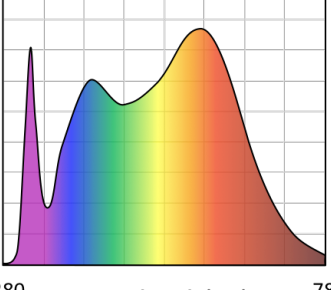
<p>VIVID 2700K</p>	 <p>Rf: 90, Rg: 100, Rfh1: 95</p>	 <p>Rw: 120</p>	 <p>380 Wavelength (nm) 780</p> <p>CRI: 95, R9: 95</p>
<p>VIVID 3000K</p>	 <p>Rf: 90, Rg: 100, Rfh1: 95</p>	 <p>Rw: 120</p>	 <p>380 Wavelength (nm) 780</p> <p>CRI: 95, R9: 95</p>
<p>VIVID 4000K</p>	 <p>Rf: 90, Rg: 100, Rfh1: 95</p>	 <p>Rw: 70</p>	 <p>380 Wavelength (nm) 780</p> <p>CRI: 95, R9: 95</p>

SERIES/CCT

COLOR ACCURACY

WHITENESS INDEX

SPECTRAL POWER DISTRIBUTION

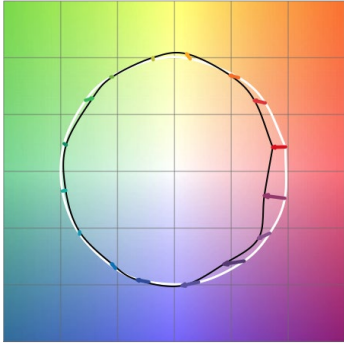
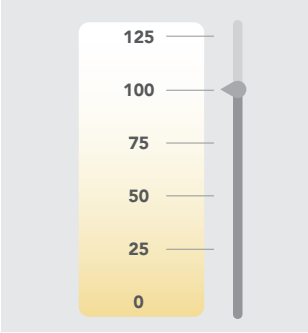
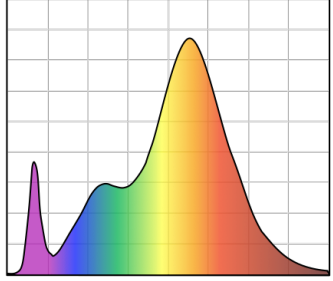
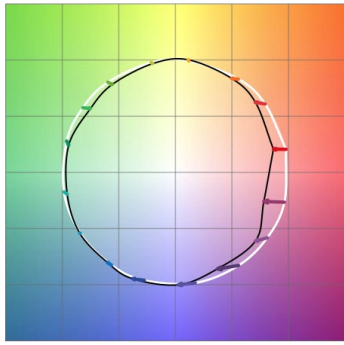
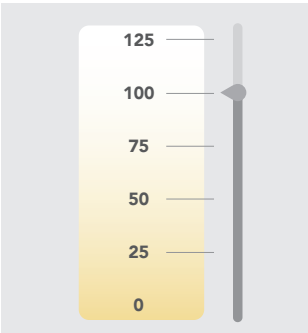
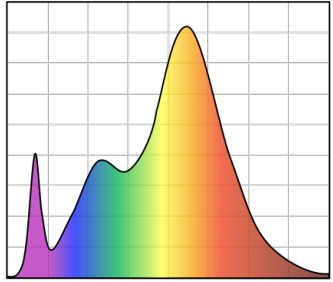
<p>BRILLIANT 2700K</p>	 <p>Rf: 85, Rg: 92, Rfh1: 77</p>	 <p>Rw: 100</p>	 <p>CRI: 85, R9: >0</p>
<p>BRILLIANT 3000K</p>	 <p>Rf: 85, Rg: 92, Rfh1: 77</p>	 <p>Rw: 100</p>	 <p>CRI: 85, R9: >0</p>

Rf: TM-30 metric measuring color fidelity (whether colors are similar to those under natural light). Rf is a more accurate version of the CRI Ra. Rf is 100 for natural light.

Rg: TM-30 metric measuring color gamut (whether colors are more saturated than under natural light). Rg is 100 for natural light.

Rfh1: TM-30 metric measuring color fidelity for red tones. Rfh1 is a more accurate version of the CRI R9. Rfh1 is 100 for natural light.

Rw: Soraa-developed metric to measure white fidelity. Rw measures the magnitude of excitation of whitening agents within whites. Rw is about 100 for natural light.