

MR16 9W



OUTPUT RANGE: VIVID SERIES 465 - 490 lumen

OUTPUT RANGE: BRILLIANT SERIES 560 - 590 lumen

BEAM ANGLE RANGE 25°, 36°

COLOR TEMPERATURE RANGE 2700K, 3000K

APPLICATION Not suitable for enclosed, lensed, baffled, or deeply recessed fixtures. Halogen replacement for indoor applications.

FLICKER FREE



12V AC



GU-5.3



DIM



POINT SOURCE OPTICS

Exceptional beam control with smooth uniform beams
Single light source, single crisp shadow

VP₃ VIVID COLOR AND VP₃ NATURAL WHITE

VIVID series provides accurate color rendering across the visible spectrum from 400nm to 700nm, with CRI/95, R9/95, Rf/90, Rg/100

Whiteness rendering matches or exceeds that of halogen and incandescent sources at 2700K and 3000K

ENERGY EFFICIENCY AND LONG LIFE

85% more energy efficient than standard halogen lamps

Typical payback of one year or less

Rated lifetime to L70: 35,000hrs

Warranty: 3yrs or 25,000hrs whichever comes first.

Detailed warranty information available at sora.com/resources/legal

CERTIFICATIONS

JA8-2016-E, UL/CUL Class 2 and non-Class 2, FCC Title 47 Part 15B, RoHS, CE



RoHS

HIGHLY COMPATIBLE

Geometrically compatible with standard fixtures

Not suitable for enclosed, lensed, baffled, or deeply recessed fixtures

Suitable for damp locations

Works with trailing edge and leading edge phase cut dimmers, 12V AC magnetic and electronic transformers and 12V DC transformers (see www.sora.com/resources)

INTENDED USE AND APPLICATIONS

Intended for use in MR16 compatible recessed downlights, track lighting and other indoor applications

Soraa lamps are designed to safely turn down in high temperature environments to protect LED and components.

GENERAL SPECIFICATIONS

Form Factor	Operating Temperature	Electrical	Dimming and Flicker
Width: 50.1mm (1.97")	Minimum: -40°C (ambient)	Wattage: 9W	Dimmable to <20%
Height: 45.5mm (1.79")	Typical: 90°C - 95°C (base)	Power factor: 0.92	Flicker Index: 0.02
Weight: 47g	Maximum: 100°C (base)	Voltage: 12V +/- 1.2V	Percent Flicker: 5%*
		Frequency: 50/60Hz	

* These Soraa lamps are certified to California's demanding JA8 standard, which requires <30% flicker

DIMENSIONS

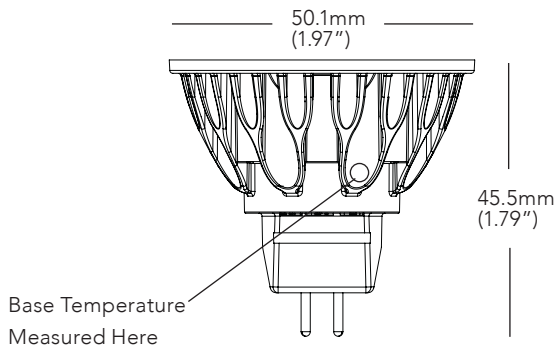

COLOR RENDERING

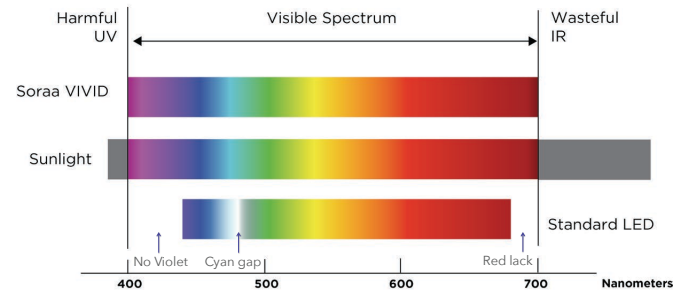

25 DEGREE BEAM

Beam Dia at 50% CBCP (ft)	Field Dia at 10% CBCP (ft)	Foot-candles (% of CBCP)
1.3	2.2	11.1%
2.7	4.4	2.8%
4.0	6.6	1.2%
5.3	8.7	0.7%
6.7	10.9	0.4%

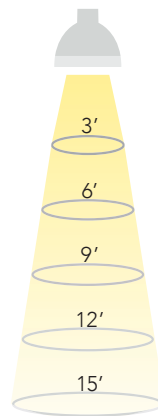

36 DEGREE BEAM

Beam Dia at 50% CBCP (ft)	Field Dia at 10% CBCP (ft)	Foot-candles (% of CBCP)
1.9	3.3	11.1%
3.9	6.5	2.8%
5.8	9.8	1.2%
7.8	13.0	0.7%
9.7	16.3	0.4%

Note: Footcandles may be calculated by multiplying the CBCP of the desired model number by the percentage in the tables above

SPECIFICATIONS BY MODEL NUMBER* SORAA LED MR16 9W

Model #	Product Code	CCT (K)	Beam Angle	CBCP (Cd)	Halogen Equivalent	Total Flux (Lm)	Efficacy (Lm/W)	McA	JA8-2016-E	SNAP
VIVID SERIES										
SM16-09-25D-927-03	00955	2700	25	2570	60	465	52	3	YES	-
SM16-09-36D-927-03	00963	2700	36	1210	60	465	52	3	YES	-
SM16-09-25D-930-03	00959	3000	25	2700	60	490	54	3	YES	-
SM16-09-36D-930-03	00967	3000	36	1280	60	490	54	3	YES	-
BRILLIANT SERIES										
SM16-09-25D-827-03	00953	2700	25	3090	75	560	62	3	NA	-
SM16-09-36D-827-03	00961	2700	36	1460	75	560	62	3	NA	-
SM16-09-25D-830-03	00957	3000	25	3260	75	590	66	3	NA	-
SM16-09-36D-830-03	00965	3000	36	1540	75	590	66	3	NA	-

CCT: Correlated Color Temperature **McA**: White Point Accuracy in McA step **SNAP**: SORAA SNAP System Compatible

*Specifications are at stable warm operating conditions (25°C ambient)

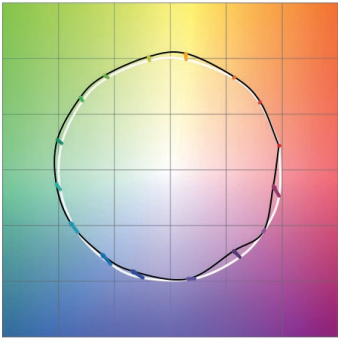
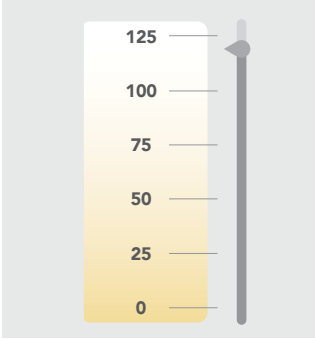
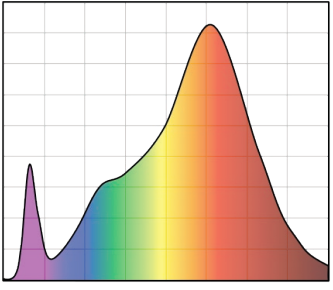
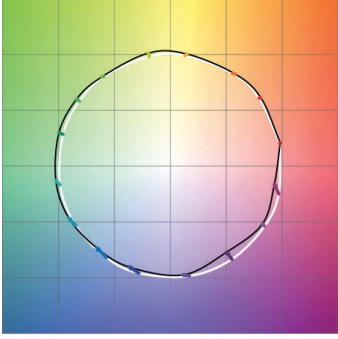
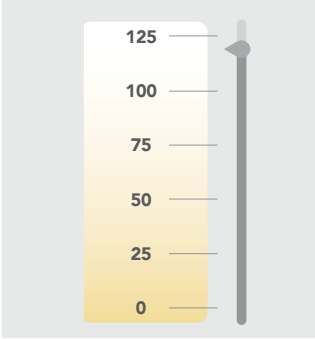
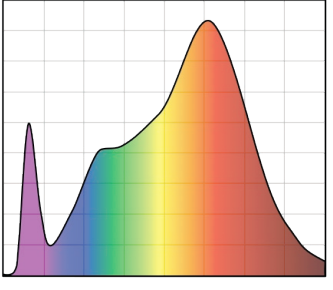
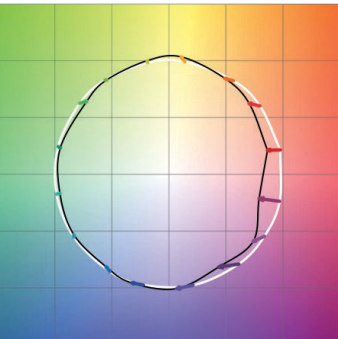
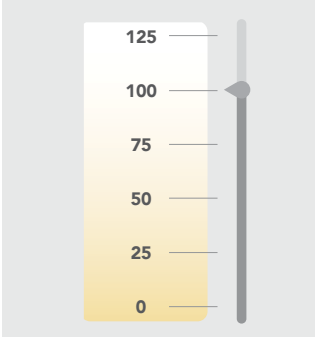
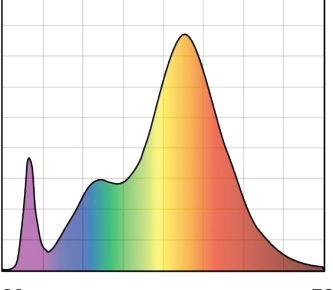
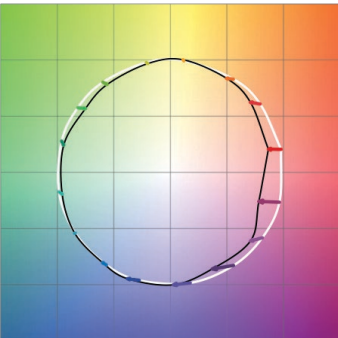
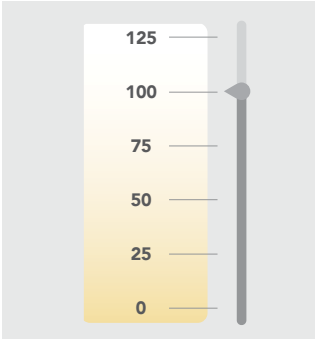
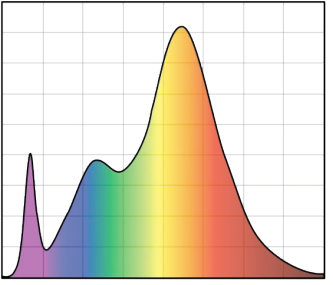
SERIES/CCT	COLOR ACCURACY	WHITENESS INDEX	SPECTRAL POWER DISTRIBUTION
VIVID 2700K	 <p>Rf: 90, Rg: 100, Rfh1: 95</p>	 <p>Rw: 120</p>	 <p>380 Wavelength (nm) 780</p> <p>CRI: 95, R9: 95</p>
VIVID 3000K	 <p>Rf: 90, Rg: 100, Rfh1: 95</p>	 <p>Rw: 120</p>	 <p>380 Wavelength (nm) 780</p> <p>CRI: 95, R9: 95</p>
BRILLIANT 2700K	 <p>Rf: 85, Rg: 92, Rfh1: 77</p>	 <p>Rw: 100</p>	 <p>380 Wavelength (nm) 780</p> <p>CRI: 85, R9: >0</p>
BRILLIANT 3000K	 <p>Rf: 85, Rg: 92, Rfh1: 77</p>	 <p>Rw: 100</p>	 <p>380 Wavelength (nm) 780</p> <p>CRI: 85, R9: >0</p>

Rf: TM-30 metric measuring color fidelity (whether colors are similar to those under natural light). Rf is a more accurate version of the CRI Ra. Rf is 100 for natural light.
Rg: TM-30 metric measuring color gamut (whether colors are more saturated than under natural light). Rg is 100 for natural light.
Rfh1: TM-30 metric measuring color fidelity for red tones. Rfh1 is a more accurate version of the CRI R9. Rfh1 is 100 for natural light.
Rw: Soraa-developed metric to measure white fidelity. Rw measures the magnitude of excitation of whitening agents within whites. Rw is about 100 for natural light.