



PAR30L 18.5W

| | |
|---------------------------------------|---|
| OUTPUT RANGE: VIVID SERIES | 930 - 1040 lumen |
| OUTPUT RANGE: BRILLIANT SERIES | 1190 - 1280 lumen |
| BEAM ANGLE RANGE | 9°, 25°, 36°, 60° |
| COLOR TEMPERATURE RANGE | 2700K, 3000K, 4000K |
| APPLICATION | Halogen replacement for indoor & outdoor applications |



POINT SOURCE OPTICS

Exceptional beam control enables unique 9° narrow spot and smooth uniform beams

Single light source, single crisp shadow

VP₃ VIVID COLOR AND VP₃ NATURAL WHITE

VIVID series provides accurate color rendering across the visible spectrum from 400nm to 700nm, with CRI/95, R9/95, Rf/90, Rg/100

Whiteness rendering matches or exceeds that of halogen and incandescent sources at 2700K and 3000K

ENERGY EFFICIENCY AND LONG LIFE

85% more energy efficient than standard halogen lamps

Typical payback of one year or less

Rated lifetime to L70: 35,000hrs

Warranty: 3yrs or 25,000hrs whichever comes first

Detailed warranty information available at sora.com/resources/legal

CERTIFICATIONS

RoHS, CE, UL/CUL, FCC Title 47 Part 15B



HIGHLY COMPATIBLE

Narrow spot compatible with Soraa SNAP System accessories

Thermally and geometrically compatible with standard fixtures and suitable for damp locations

Suitable for fully enclosed fixtures. Can be used with front glass cover

Works with trailing edge and leading edge phase cut dimmers (see www.sora.com/resources)

INTENDED USE AND APPLICATIONS

Intended for use in PAR30L compatible recessed downlights, track lighting and other indoor and outdoor applications

Soraa lamps are designed to safely turn down in any thermal environment not conducive to minimum airflow or proper ventilation

GENERAL SPECIFICATIONS

| Form Factor | Operating Temperature | Electrical | Dimming and Flicker |
|-----------------------|-----------------------------|-----------------------|-----------------------|
| Width: 96mm (3.78") | Minimum: -40°C (ambient) | Wattage: 18.5W | Dimmable to <10% |
| Height: 113mm (4.45") | Typical: 70°C - 80°C (base) | Power factor: 0.95 | Flicker Index: <0.1 |
| Weight: 295g | Maximum: 90°C (base) | Voltage: 120V +/- 12V | Percent Flicker: 28%* |
| | | Frequency: 50/60Hz | |

* These Soraa lamps are certified to California's demanding JA8 standard, which requires <30% flicker

DIMENSIONS

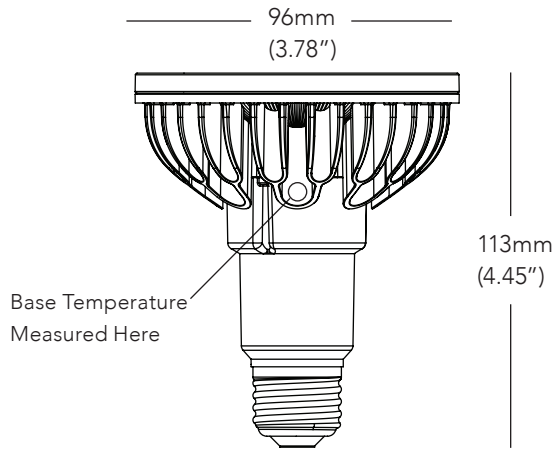

COLOR RENDERING

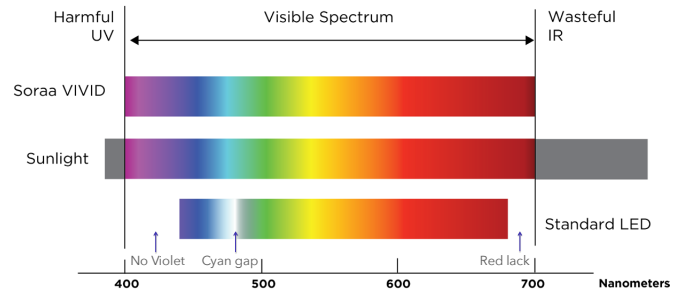

9 DEGREE BEAM

| Beam Dia at 50% CBCP (ft) | Field Dia at 10% CBCP (ft) | Foot-candles (% of CBCP) |
|---------------------------|----------------------------|--------------------------|
| 0.5 | 0.8 | 8.6% |
| 0.9 | 1.7 | 2.5% |
| 1.4 | 2.5 | 1.2% |
| 1.9 | 3.4 | 0.7% |
| 2.4 | 4.2 | 0.4% |

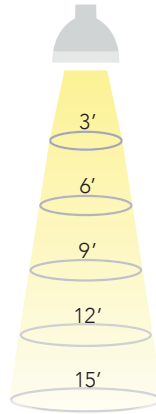

25 DEGREE BEAM

| Beam Dia at 50% CBCP (ft) | Field Dia at 10% CBCP (ft) | Foot-candles (% of CBCP) |
|---------------------------|----------------------------|--------------------------|
| 1.3 | 2.2 | 8.6% |
| 2.7 | 4.4 | 2.5% |
| 4.0 | 6.6 | 1.2% |
| 5.3 | 8.7 | 0.7% |
| 6.7 | 10.9 | 0.4% |

60 DEGREE BEAM

36 DEGREE BEAM

| Beam Dia at 50% CBCP (ft) | Field Dia at 10% CBCP (ft) | Foot-candles (% of CBCP) |
|---------------------------|----------------------------|--------------------------|
| 1.9 | 3.5 | 8.6% |
| 3.9 | 6.9 | 2.5% |
| 5.8 | 10.4 | 1.2% |
| 7.8 | 13.9 | 0.7% |
| 9.7 | 17.3 | 0.4% |

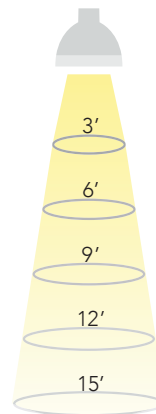

| Beam Dia at 50% CBCP (ft) | Field Dia at 10% CBCP (ft) | Foot-candles (% of CBCP) |
|---------------------------|----------------------------|--------------------------|
| 3.5 | 6.0 | 8.6% |
| 6.9 | 12.0 | 2.5% |
| 10.4 | 18.0 | 1.2% |
| 13.9 | 24.0 | 0.7% |
| 17.3 | 30.0 | 0.4% |

Note: Footcandles may be calculated by multiplying the CBCP of the desired model number by the percentage in the tables above

SPECIFICATIONS BY MODEL NUMBER* SORAA LED PAR30L 18.5W

| Model # | Product Code | CCT (K) | Beam Angle | Field Angle | CBCP (Cd) | Halogen Equivalent | Total Flux (Lm) | Efficacy (Lm/W) | McA | JA8-2016 | SNAP |
|-------------------------|--------------|---------|------------|-------------|-----------|--------------------|-----------------|-----------------|-----|----------|------|
| VIVID SERIES | | | | | | | | | | | |
| SP30L-18-09D-927-03 | 00763 | 2700 | 9 | 16 | 17200 | 100 | 930 | 50 | 3 | YES | YES |
| SP30L-18-25D-927-03 | 00765 | 2700 | 25 | 40 | 5020 | 100 | 930 | 50 | 3 | YES | - |
| SP30L-18-36D-927-03 | 00767 | 2700 | 36 | 60 | 2320 | 100 | 930 | 50 | 3 | YES | - |
| SP30L-18-60D-927-03 | 00769 | 2700 | 60 | 90 | 1020 | 100 | 930 | 50 | 3 | YES | - |
| SP30L-18-09D-930-03 | 00779 | 3000 | 9 | 16 | 18500 | 100 | 1000 | 54 | 3 | YES | YES |
| SP30L-18-25D-930-03 | 00781 | 3000 | 25 | 40 | 5400 | 100 | 1000 | 54 | 3 | YES | - |
| SP30L-18-36D-930-03 | 00783 | 3000 | 36 | 60 | 2500 | 100 | 1000 | 54 | 3 | YES | - |
| SP30L-18-60D-930-03 | 00785 | 3000 | 60 | 90 | 1100 | 100 | 1000 | 54 | 3 | YES | - |
| SP30L-18-09D-940-03 | 00795 | 4000 | 9 | 16 | 19240 | 100 | 1040 | 56 | 4 | NA | YES |
| SP30L-18-25D-940-03 | 00797 | 4000 | 25 | 40 | 5600 | 100 | 1040 | 56 | 4 | NA | - |
| SP30L-18-36D-940-03 | 00799 | 4000 | 36 | 60 | 2600 | 100 | 1040 | 56 | 4 | NA | - |
| SP30L-18-60D-940-03 | 00801 | 4000 | 60 | 90 | 1140 | 100 | 1040 | 56 | 4 | NA | - |
| BRILLIANT SERIES | | | | | | | | | | | |
| SP30L-18-09D-827-03 | 00771 | 2700 | 9 | 16 | 22000 | 120 | 1190 | 64 | 3 | NA | YES |
| SP30L-18-25D-827-03 | 00773 | 2700 | 25 | 40 | 6420 | 120 | 1190 | 64 | 3 | NA | - |
| SP30L-18-36D-827-03 | 00775 | 2700 | 36 | 60 | 2960 | 120 | 1190 | 64 | 3 | NA | - |
| SP30L-18-60D-827-03 | 00777 | 2700 | 60 | 90 | 1300 | 120 | 1190 | 64 | 3 | NA | - |
| SP30L-18-09D-830-03 | 00787 | 3000 | 9 | 16 | 23680 | 120 | 1280 | 69 | 3 | NA | YES |
| SP30L-18-25D-830-03 | 00789 | 3000 | 25 | 40 | 6900 | 120 | 1280 | 69 | 3 | NA | - |
| SP30L-18-36D-830-03 | 00791 | 3000 | 36 | 60 | 3200 | 120 | 1280 | 69 | 3 | NA | - |
| SP30L-18-60D-830-03 | 00793 | 3000 | 60 | 90 | 1400 | 120 | 1280 | 69 | 3 | NA | - |

CCT: Correlated Color Temperature **McA:** White Point Accuracy in McA step **SNAP:** SORAA SNAP System Compatible

*Specifications are at stable warm operating conditions (25°C ambient)

SERIES/CCT

COLOR ACCURACY

WHITENESS INDEX

SPECTRAL POWER DISTRIBUTION

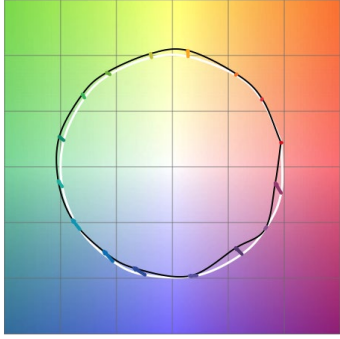
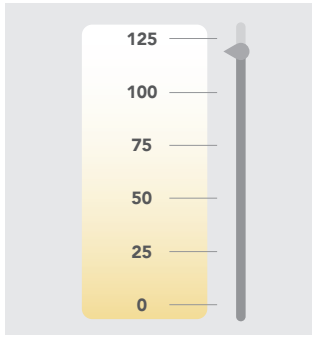
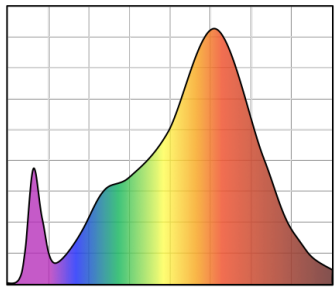
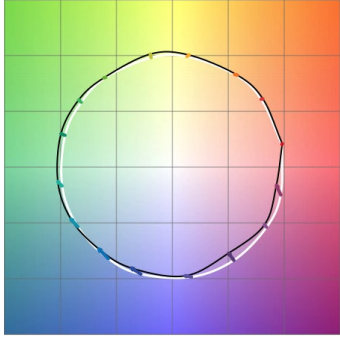
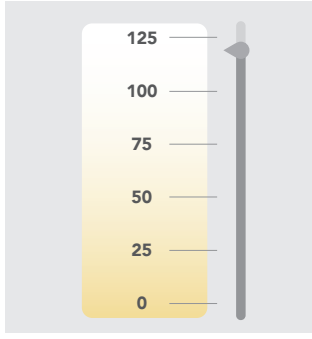
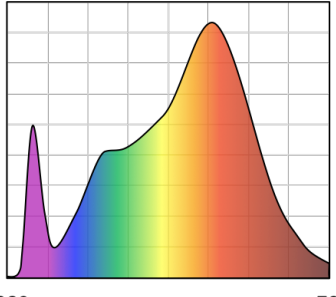
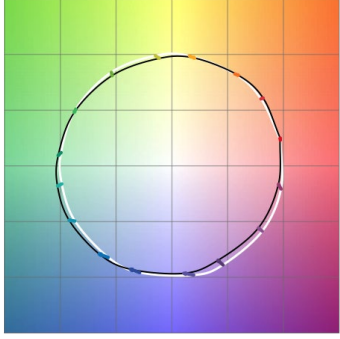
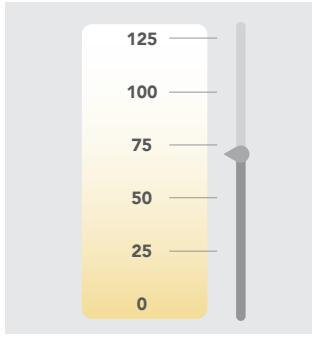
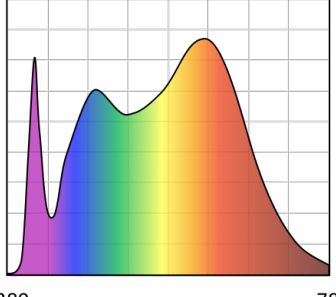
| | | | |
|-------------------------------|--|--|---|
| <p>VIVID 2700K</p> |  <p>Rf: 90, Rg: 100, Rfh1: 95</p> |  <p>Rw: 120</p> |  <p>380 Wavelength (nm) 780</p> <p>CRI: 95, R9: 95</p> |
| <p>VIVID 3000K</p> |  <p>Rf: 90, Rg: 100, Rfh1: 95</p> |  <p>Rw: 120</p> |  <p>380 Wavelength (nm) 780</p> <p>CRI: 95, R9: 95</p> |
| <p>VIVID 4000K</p> |  <p>Rf: 90, Rg: 100, Rfh1: 95</p> |  <p>Rw: 70</p> |  <p>380 Wavelength (nm) 780</p> <p>CRI: 95, R9: 95</p> |

SERIES/CCT

COLOR ACCURACY

WHITENESS INDEX

SPECTRAL POWER DISTRIBUTION

| | | | |
|-----------------------------------|--|--|--|
| <p>BRILLIANT 2700K</p> |  <p>Rf: 85, Rg: 92, Rfh1: 77</p> |  <p>Rw: 100</p> |  <p>Wavelength (nm) 380 780</p> <p>CRI: 85, R9: >0</p> |
| <p>BRILLIANT 3000K</p> |  <p>Rf: 85, Rg: 92, Rfh1: 77</p> |  <p>Rw: 100</p> |  <p>Wavelength (nm) 380 780</p> <p>CRI: 85, R9: >0</p> |

Rf: TM-30 metric measuring color fidelity (whether colors are similar to those under natural light). Rf is a more accurate version of the CRI Ra. Rf is 100 for natural light.
 Rg: TM-30 metric measuring color gamut (whether colors are more saturated than under natural light). Rg is 100 for natural light.
 Rfh1: TM-30 metric measuring color fidelity for red tones. Rfh1 is a more accurate version of the CRI R9. Rfh1 is 100 for natural light.
 Rw: Soraa-developed metric to measure white fidelity. Rw measures the magnitude of excitation of whitening agents within whites. Rw is about 100 for natural light.