



PAR30L 18.5W

OUTPUT RANGE: VIVID SERIES	930 - 1040 lumen
OUTPUT RANGE: BRILLIANT SERIES	1190 - 1280 lumen
BEAM ANGLE RANGE	9°, 25°, 36°, 60°
COLOR TEMPERATURE RANGE	2700K, 3000K, 4000K
APPLICATION	Halogen replacement for indoor & outdoor applications



POINT SOURCE OPTICS

Exceptional beam control enables unique 9° narrow spot and smooth uniform beams

Single light source, single crisp shadow

VP₃ VIVID COLOR AND VP₃ NATURAL WHITE

VIVID series provides accurate color rendering across the visible spectrum from 400nm to 700nm, with CRI/95, R9/95, Rf/90, Rg/100

Whiteness rendering matches or exceeds that of halogen and incandescent sources at 2700K and 3000K

ENERGY EFFICIENCY AND LONG LIFE

85% more energy efficient than standard halogen lamps

Typical payback of one year or less

Rated lifetime to L70: 35,000hrs

Warranty: 3yrs or 25,000hrs whichever comes first

Detailed warranty information available at soraa.com/resources/legal

CERTIFICATIONS

RoHS, CE, UL/CUL, FCC Title 47 Part 15B



HIGHLY COMPATIBLE

Narrow spot compatible with Soraa SNAP System accessories

Thermally and geometrically compatible with standard fixtures and suitable for damp locations

Suitable for fully enclosed fixtures. Can be used with front glass cover

Works with trailing edge and leading edge phase cut dimmers (see www.soraa.com/resources)

INTENDED USE AND APPLICATIONS

Intended for use in PAR30L compatible recessed downlights, track lighting and other indoor and outdoor applications

Soraa lamps are designed to safely turn down in any thermal environment not conducive to minimum airflow or proper ventilation

GENERAL SPECIFICATIONS

Form Factor	Operating Temperature	Electrical	Dimming and Flicker
Width: 96mm (3.78")	Minimum: -40°C (ambient)	Wattage: 18.5W	Dimmable to <10%
Height: 113mm (4.45")	Typical: 70°C - 80°C (base)	Power factor: 0.95	Flicker Index: <0.1
Weight: 295g	Maximum: 90°C (base)	Voltage: 120V +/- 12V	Percent Flicker: 28%*
		Frequency: 50/60Hz	

* These Soraa lamps are certified to California's demanding JA8 standard, which requires <30% flicker

DIMENSIONS

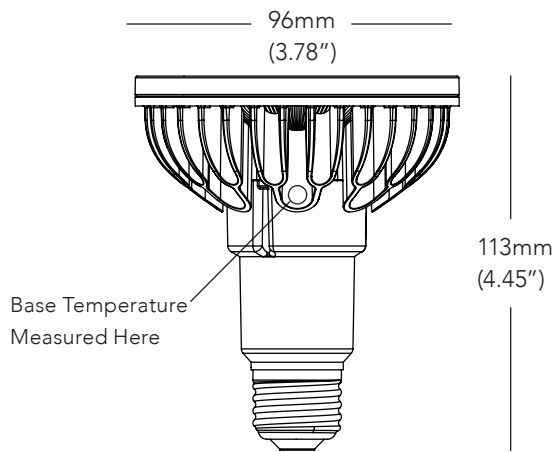

COLOR RENDERING

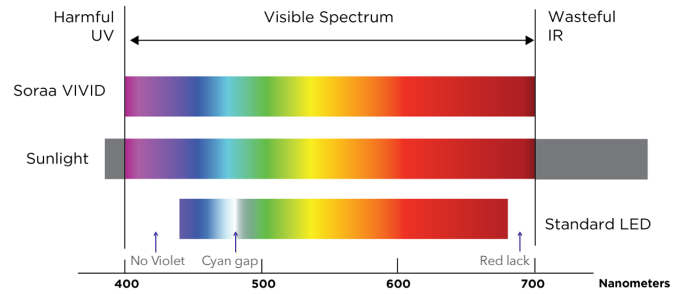

9 DEGREE BEAM

Beam Dia at 50% CBCP (ft)	Field Dia at 10% CBCP (ft)	Foot-candles (% of CBCP)
0.5	0.8	8.6%
0.9	1.7	2.5%
1.4	2.5	1.2%
1.9	3.4	0.7%
2.4	4.2	0.4%

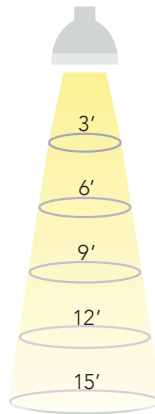

25 DEGREE BEAM

Beam Dia at 50% CBCP (ft)	Field Dia at 10% CBCP (ft)	Foot-candles (% of CBCP)
1.3	2.2	8.6%
2.7	4.4	2.5%
4.0	6.6	1.2%
5.3	8.7	0.7%
6.7	10.9	0.4%

60 DEGREE BEAM

36 DEGREE BEAM

Beam Dia at 50% CBCP (ft)	Field Dia at 10% CBCP (ft)	Foot-candles (% of CBCP)
1.9	3.5	8.6%
3.9	6.9	2.5%
5.8	10.4	1.2%
7.8	13.9	0.7%
9.7	17.3	0.4%

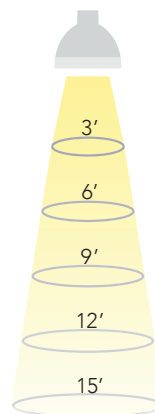

Beam Dia at 50% CBCP (ft)	Field Dia at 10% CBCP (ft)	Foot-candles (% of CBCP)
3.5	6.0	8.6%
6.9	12.0	2.5%
10.4	18.0	1.2%
13.9	24.0	0.7%
17.3	30.0	0.4%

Note: Footcandles may be calculated by multiplying the CBCP of the desired model number by the percentage in the tables above

SPECIFICATIONS BY MODEL NUMBER* SORAA LED PAR30L 18.5W

Model #	Product Code	CCT (K)	Beam Angle	Field Angle	CBCP (Cd)	Halogen Equivalent	Total Flux (Lm)	Efficacy (Lm/W)	McA	JA8-2016	SNAP
VIVID SERIES											
SP30L-18-09D-927-03	00763	2700	9	16	17200	100	930	50	3	YES	YES
SP30L-18-25D-927-03	00765	2700	25	40	5020	100	930	50	3	YES	-
SP30L-18-36D-927-03	00767	2700	36	60	2320	100	930	50	3	YES	-
SP30L-18-60D-927-03	00769	2700	60	90	1020	100	930	50	3	YES	-
SP30L-18-09D-930-03	00779	3000	9	16	18500	100	1000	54	3	YES	YES
SP30L-18-25D-930-03	00781	3000	25	40	5400	100	1000	54	3	YES	-
SP30L-18-36D-930-03	00783	3000	36	60	2500	100	1000	54	3	YES	-
SP30L-18-60D-930-03	00785	3000	60	90	1100	100	1000	54	3	YES	-
SP30L-18-09D-940-03	00795	4000	9	16	19240	100	1040	56	4	NA	YES
SP30L-18-25D-940-03	00797	4000	25	40	5600	100	1040	56	4	NA	-
SP30L-18-36D-940-03	00799	4000	36	60	2600	100	1040	56	4	NA	-
SP30L-18-60D-940-03	00801	4000	60	90	1140	100	1040	56	4	NA	-
BRILLIANT SERIES											
SP30L-18-09D-827-03	00771	2700	9	16	22000	120	1190	64	3	NA	YES
SP30L-18-25D-827-03	00773	2700	25	40	6420	120	1190	64	3	NA	-
SP30L-18-36D-827-03	00775	2700	36	60	2960	120	1190	64	3	NA	-
SP30L-18-60D-827-03	00777	2700	60	90	1300	120	1190	64	3	NA	-
SP30L-18-09D-830-03	00787	3000	9	16	23680	120	1280	69	3	NA	YES
SP30L-18-25D-830-03	00789	3000	25	40	6900	120	1280	69	3	NA	-
SP30L-18-36D-830-03	00791	3000	36	60	3200	120	1280	69	3	NA	-
SP30L-18-60D-830-03	00793	3000	60	90	1400	120	1280	69	3	NA	-

CCT: Correlated Color Temperature **McA:** White Point Accuracy in McA step **SNAP:** SORAA SNAP System Compatible

*Specifications are at stable warm operating conditions (25°C ambient)

SERIES/CCT

COLOR ACCURACY

WHITENESS INDEX

SPECTRAL POWER DISTRIBUTION

**VIVID
2700K**

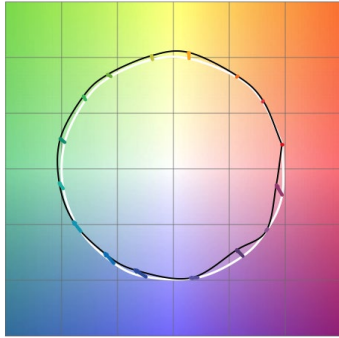

Rf: 90, Rg: 100, Rfh1: 95

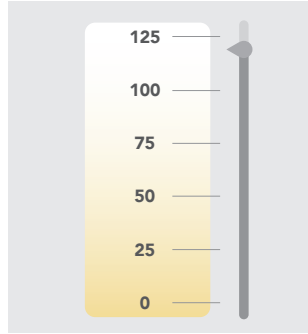

Rw: 120

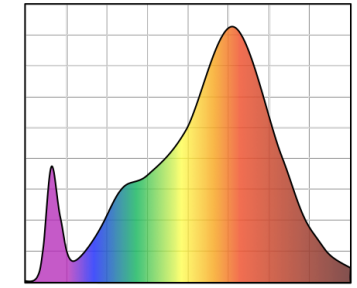

380 Wavelength (nm) 780

CRI: 95, R9: 95

**VIVID
3000K**

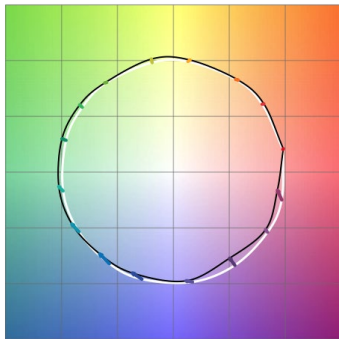

Rf: 90, Rg: 100, Rfh1: 95

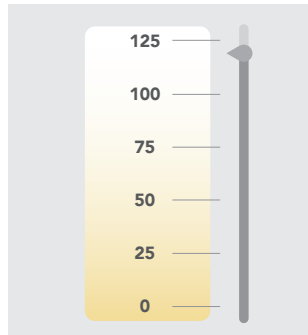

Rw: 120

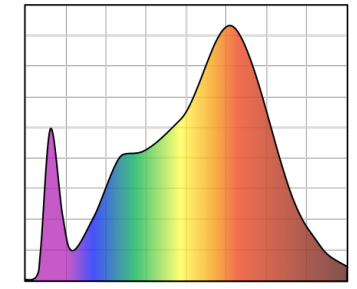

380 Wavelength (nm) 780

CRI: 95, R9: 95

**VIVID
4000K**

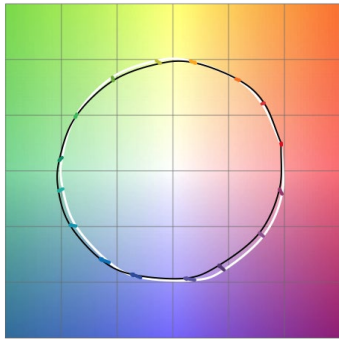

Rf: 90, Rg: 100, Rfh1: 95

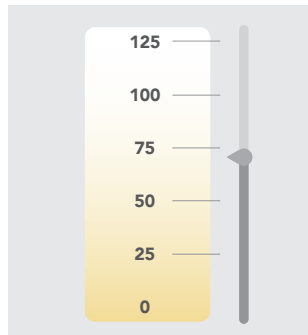

Rw: 70

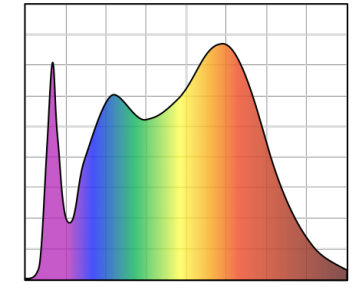

380 Wavelength (nm) 780

CRI: 95, R9: 95

SERIES/CCT

COLOR ACCURACY

WHITENESS INDEX

SPECTRAL POWER DISTRIBUTION

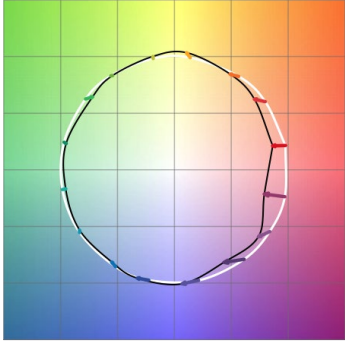
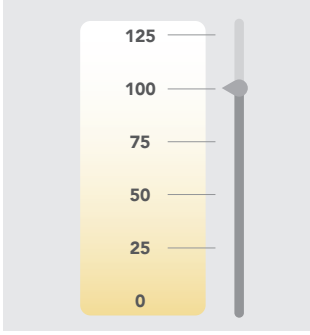
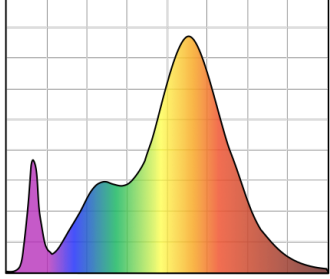
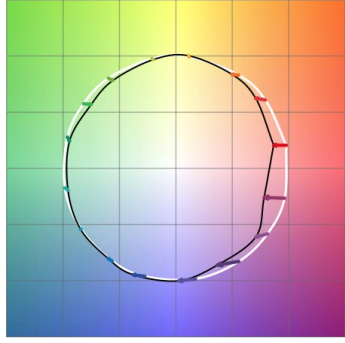
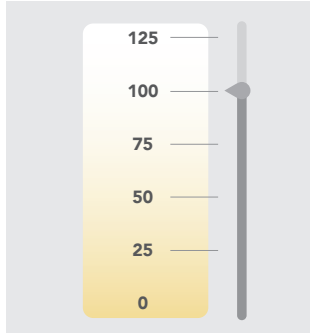
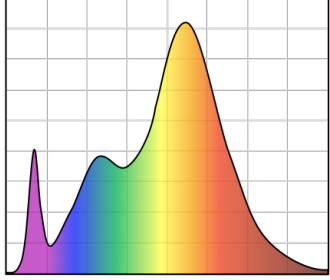
<p>BRILLIANT 2700K</p>	 <p>Rf: 85, Rg: 92, Rfh1: 77</p>	 <p>Rw: 100</p>	 <p>Wavelength (nm) 380 780</p> <p>CRI: 85, R9: >0</p>
<p>BRILLIANT 3000K</p>	 <p>Rf: 85, Rg: 92, Rfh1: 77</p>	 <p>Rw: 100</p>	 <p>Wavelength (nm) 380 780</p> <p>CRI: 85, R9: >0</p>

Rf: TM-30 metric measuring color fidelity (whether colors are similar to those under natural light). Rf is a more accurate version of the CRI Ra. Rf is 100 for natural light.
 Rg: TM-30 metric measuring color gamut (whether colors are more saturated than under natural light). Rg is 100 for natural light.
 Rfh1: TM-30 metric measuring color fidelity for red tones. Rfh1 is a more accurate version of the CRI R9. Rfh1 is 100 for natural light.
 Rw: Soraa-developed metric to measure white fidelity. Rw measures the magnitude of excitation of whitening agents within whites. Rw is about 100 for natural light.