

**PHILIPS
ADVANCE**

LED Driver

Xitanium

150W 347-480V 0.70A Fixed
XH150C070V210FNF1



Long-lasting and low maintenance, LED-based light sources are an excellent solution for all lighting applications. For optimal performance, these solutions require reliable drivers matching the long lifetime of the LEDs. The Philips Advance Xitanium LED Outdoor Driver portfolio offers a range of products specially designed to operate LED solutions in outdoor applications. These drivers are designed for hard-wired integration into outdoor luminaires for the most rugged applications. They operate to specification under wide temperature and electrical ranges to ensure reliability.

Specifications

Input Voltage (Vrms)	Output Power (W)	Output Voltage (V)	Output Current (A)	Efficiency@ Max Load and 70°C Case	Max. Case Temp. (°C)	Input Current (Arms)	Max. Input Power (W)	Inrush Current (A _{pk} /10%-µs)	THD @ Max. Load	Power Factor @ Max. Load	Surge Protection Common/Diff (KV)	Weight (Lbs/kgs)	Envir. Protection Rating
347	150	60 - 210	0.7	92	80	0.50	167	57 / 196	<10%	>0.95	4/4	1.98/ 0.90	UL Dry & Damp
480				92.5		0.35		77 / 193	<15%				

Enclosure

	In. (mm)
Case Length	8.3 (211.0)
Case Width	2.3 (58.6)
Case Height	1.48 (37.6)
Mounting Length	8.84 (224.6)
Mounting Width	0.31 (7.9)
Overall Length	9.47 (240.5)

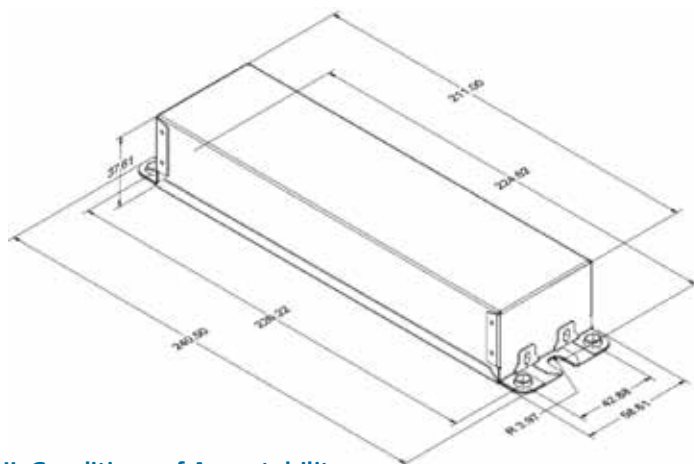

Wiring Diagram

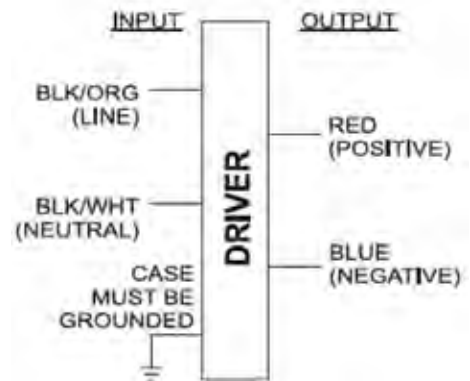

Input and output use lead-wires.

Lead-wires are 18AWG 105C/600V solid copper per UL1452.

Lead Length outside enclosure:
270 mm (±30mm) on input and output.

UL Conditions of Acceptability:

Please contact your Philips representative for a copy of the latest UL Conditions of Acceptability (COA).

Xitanium 150W 347-480V 0.70A Fixed Output

Electrical Specifications

All the specifications are typical and at 25°C Tcase unless specified otherwise.

Features

- 50,000+ hour lifetime¹
- New housing with high thermal capability

Benefits

- Enables long life luminaire designs
- Allows luminaire designs for ambient environments

Application

- Area
- Roadway
- Parking garages
- Floodlights

1. Philips Advance Xitanium LED Drivers are designed and manufactured to engineering standards correlating to an average life expectancy of 50,000 hours of operation at maximum rated case temperature. Minimum 90% survivals based on MTBF modeling.

Product Data

Order Information	
Order Code	XH150C070V210FNF1M
Full Product Code	XH150C070V210FNF1M (Mid-Pack, 10pcs/Box)
Full Product Name	XITANIUM 150W 0.7A
Line Voltage	347-480Vac_rms
Line Current	0.50A @ 347V, 0.35A @ 480V
Line Frequency	50/60Hz
Min. Mains Voltage Operational	312V
Max. Mains Voltage Operational	528V
THD (total)	Refer to graph
Power Factor (PF)	Refer to graph
Efficiency	Refer to graph
Inrush Current	Per NEMA 410
Lightning Surge Protection	Refer to table
Output Information	
Output Information	Refer to table
Output Voltage Range	60Vdc to 210Vdc
Maximum Open Circuit Voltage	300Vdc
Output Current (ripple = peak to average / average)	15% max @ max Iout and max Vout Low frequency (≤ 120 Hz) content <5%
Protections	Short Circuit and Open Circuit Protection for LED + and LED -
Ambient Operating Temp. Range	-40°C to +55°C
Max Case Temperature (Tcase)	80°C
Features	
Interfaces	NA
0-10V Dimming Specifications	NA
Environment & Approbation	
Environmental Protection Rating	UL dry and damp
Agency Approbations	UL879, UL1012, UL935, (cRUs/CSA)
Electromagnetic Compliance	FCC Title 47 Part 15 Class A
Isolation	Refer to table
Audible Noise	<24dB Class A

Xitanium 150W 347-480V 0.70A Fixed Output

Electrical Specifications

All the specifications are typical and at 25°C Tcase unless specified otherwise.

Driver Current Cutback

The Driver Current Cutback feature provides for an increased output voltage with a reduced output current during abnormal LED operation, such as cold weather starting.

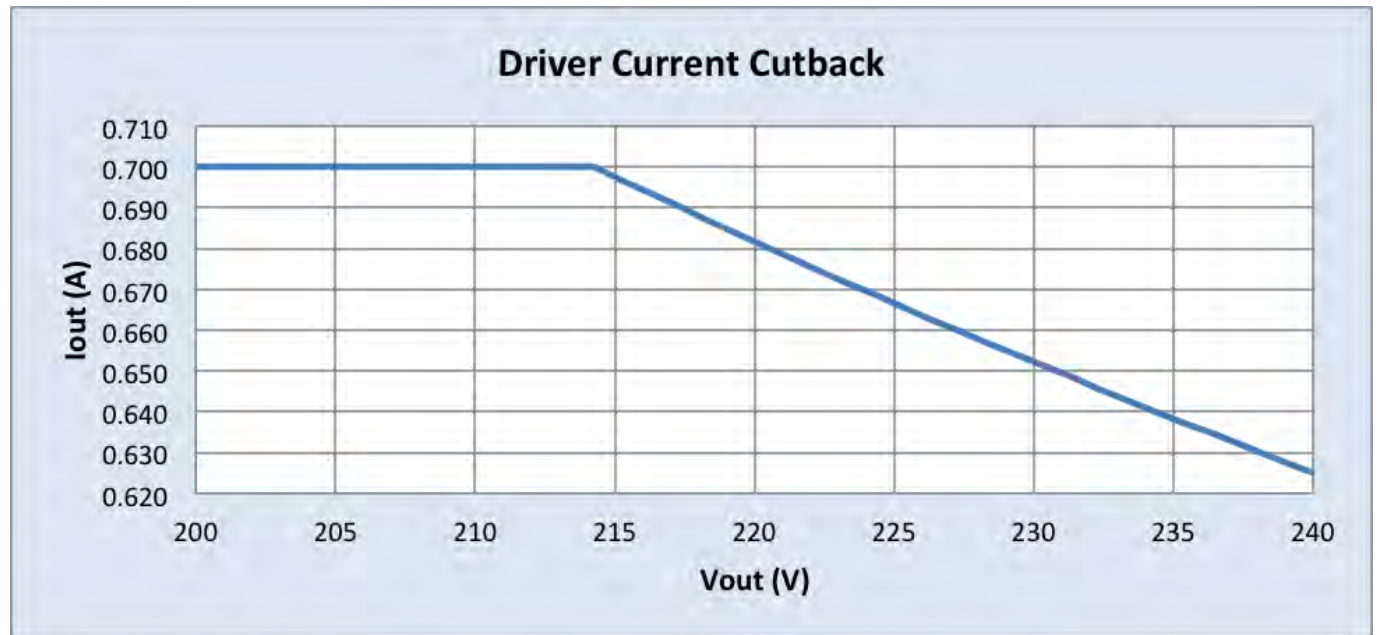

Xitanium 150W 347-480V 0.70A Fixed Output

Performance Characteristics

Based on measurements on a typical sample. The accuracy of the measurements is within the tolerance of the measurement instruments. The graphs are meant to be a guideline and not a specification.

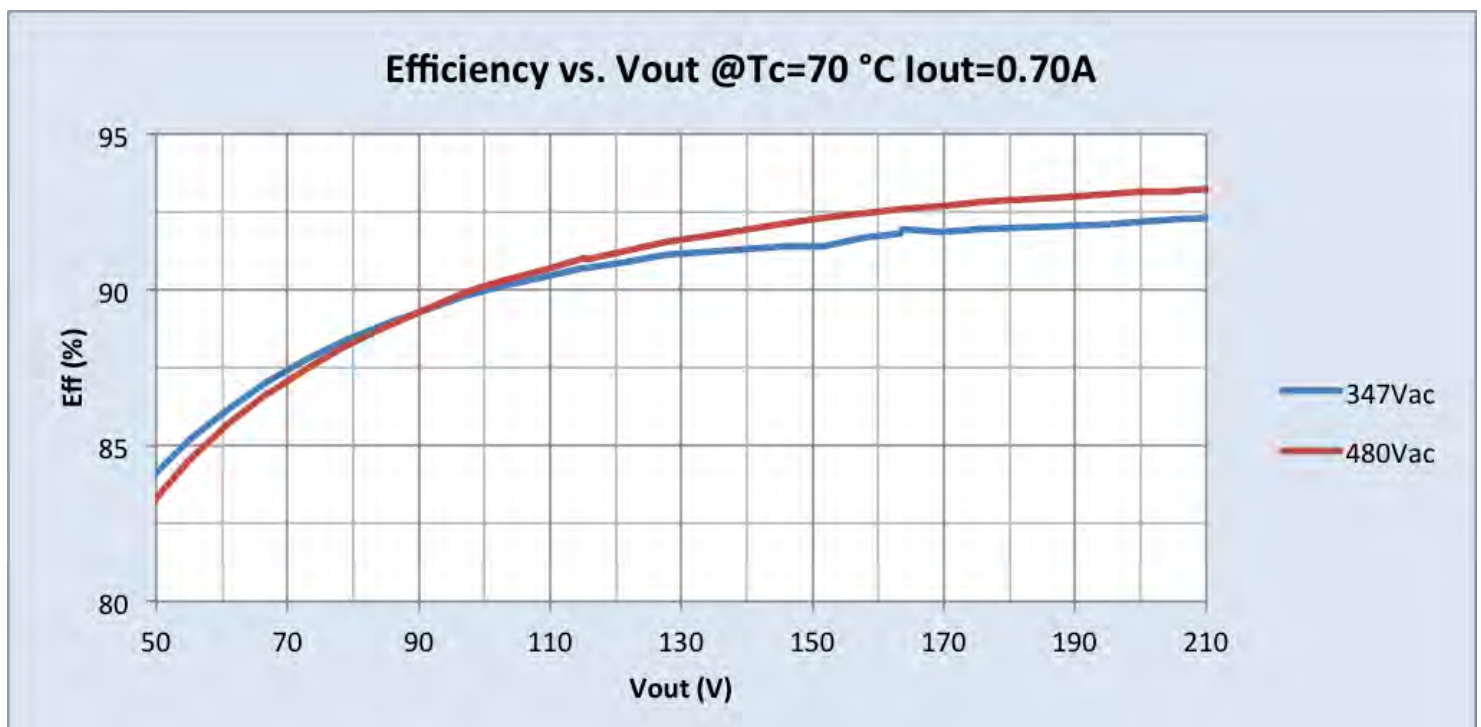
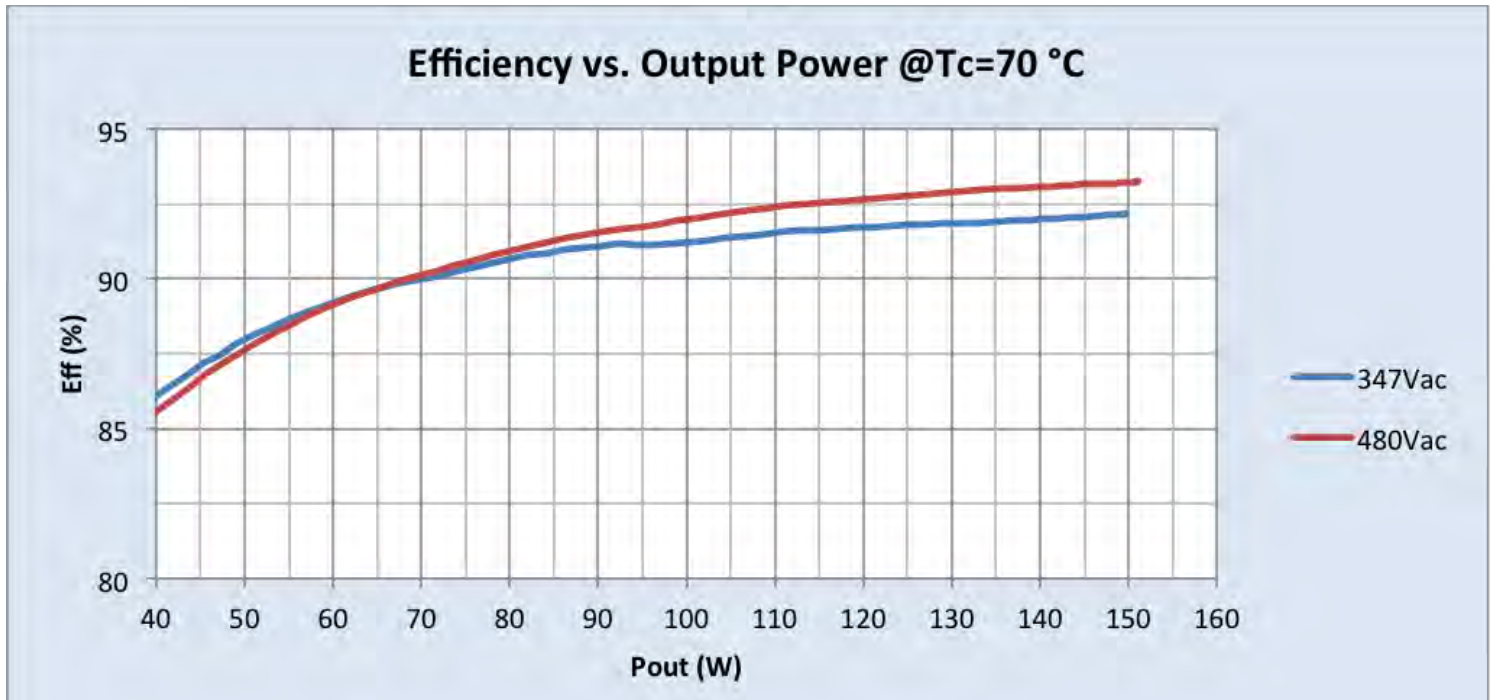

Xitanium 150W 347-480V 0.70A Fixed Output

Performance Characteristics

Based on measurements on a typical sample. The accuracy of the measurements is within the tolerance of the measurement instruments. The graphs are meant to be a guideline and not a specification.

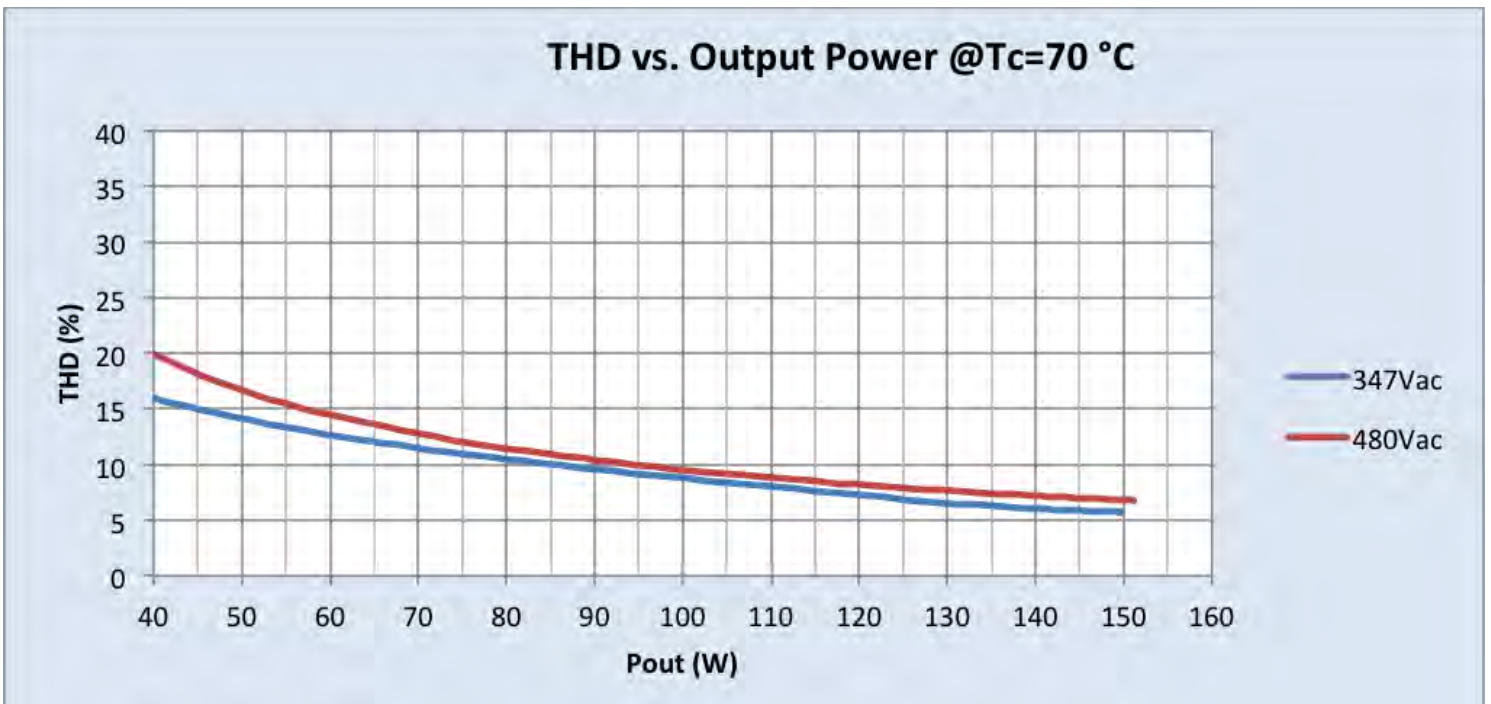
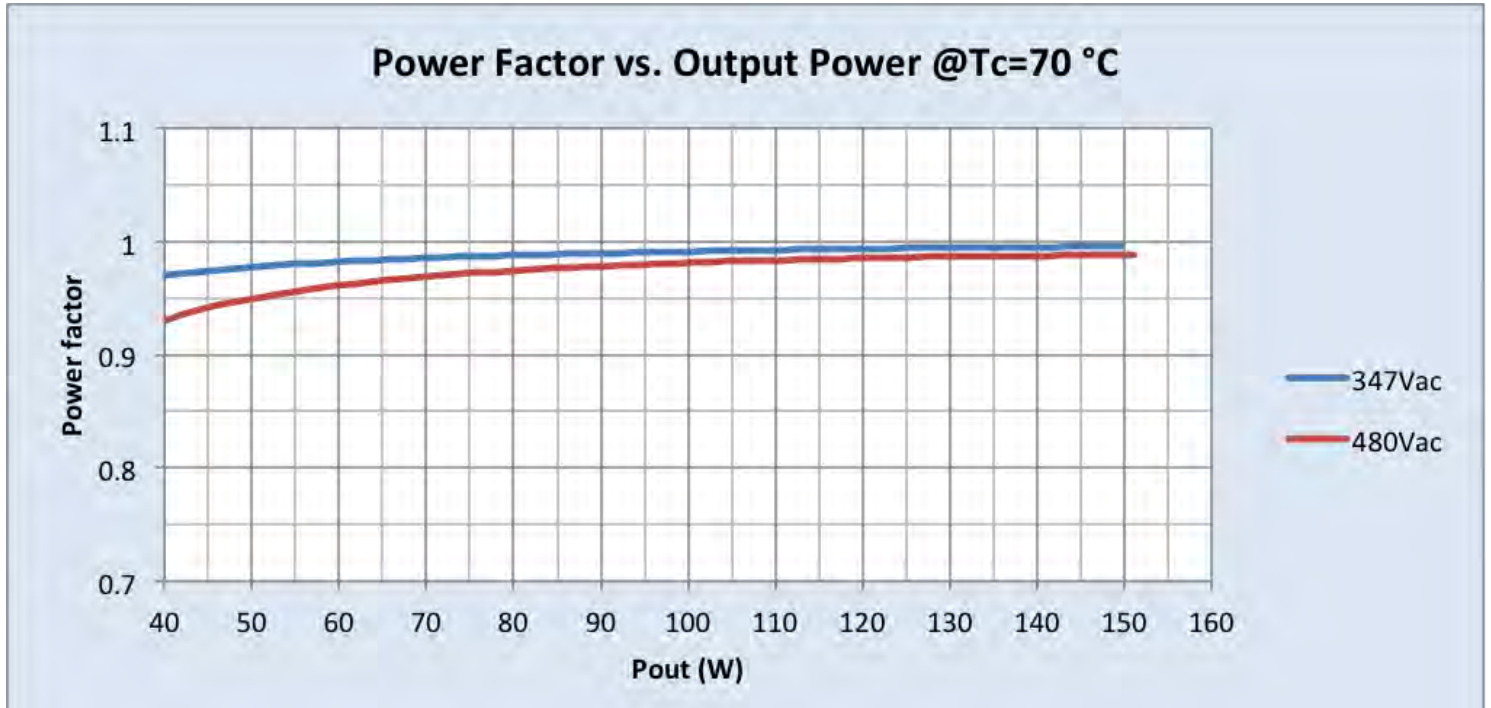

Xitanium 150W 347-480V 0.70A Fixed Output

Electrical Specifications

All the specifications are typical and at 25°C Tcase unless specified otherwise.

Output Current vs. Driver Case Temperature:

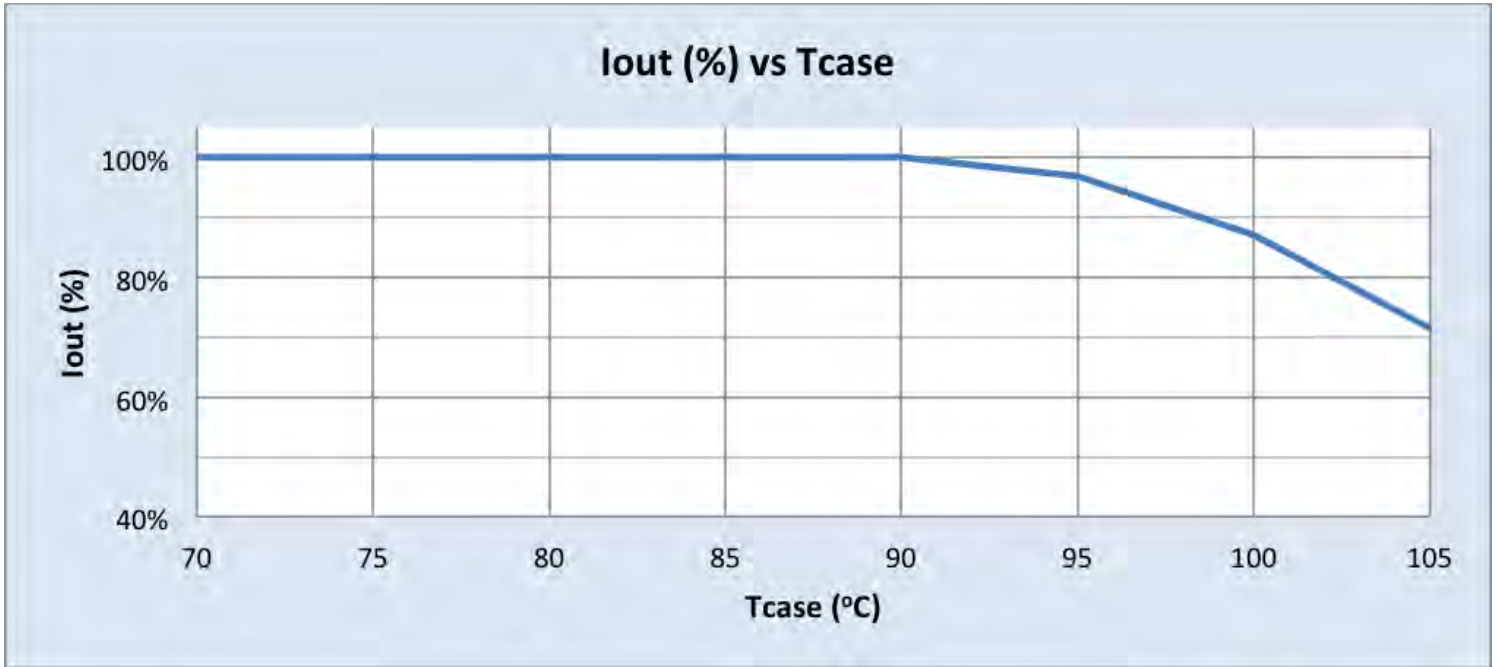

Driver Lifetime vs. Driver Case Temperature:

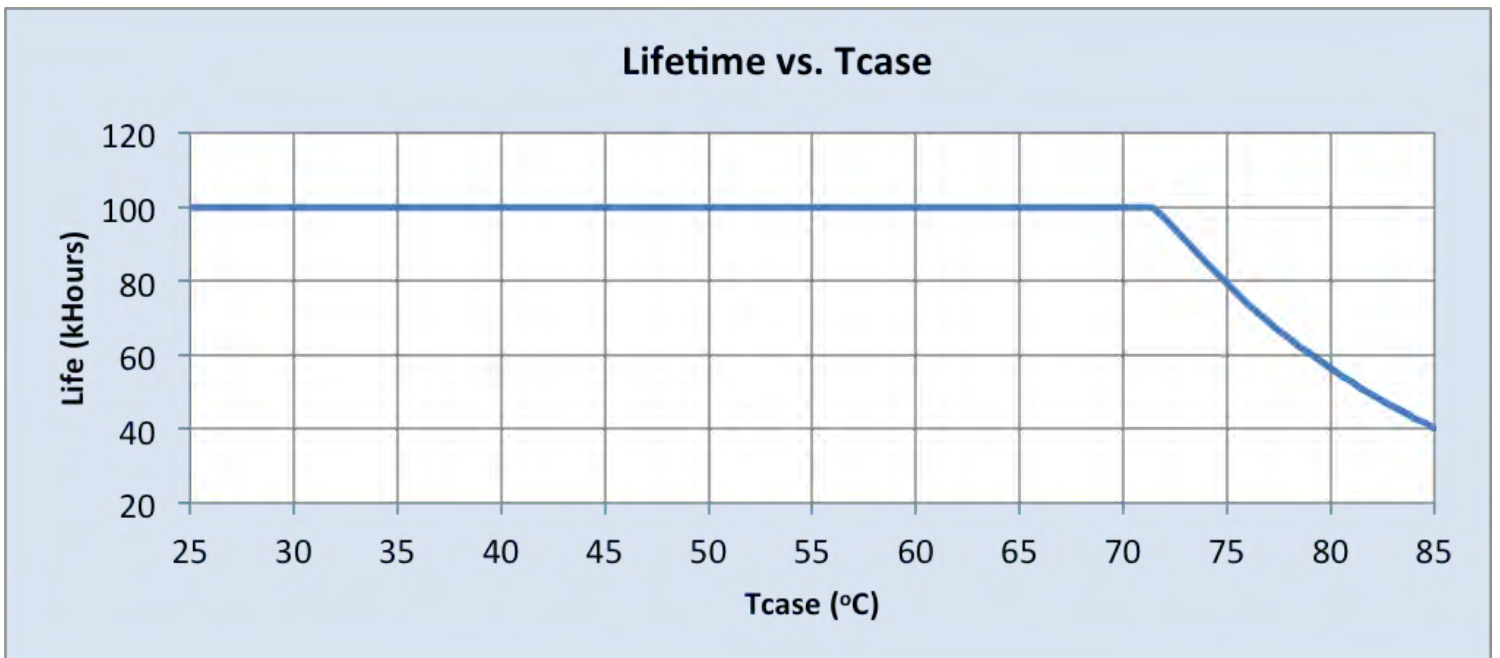

Xitanium 150W 347-480V 0.70A Fixed Output

Inrush Current Info:

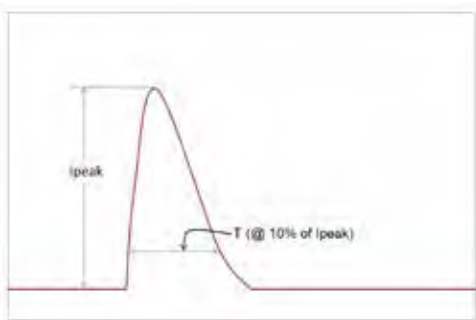

Vin	Ipeak	T (@ 10% of Ipeak)
347 Vrms	57A	196µs
480 Vrms	77A	193µs

Inrush current is measured at peak of the corresponding line voltage, source impedance per NEMA 410.

Lightning Surge Info:

ANSI Surge Type	Differential Mode (L-N)	Common Mode (L-G, N-G, L&N-G)
1.2/50µs Combination Wave (w/t 2Ω)	4kV	4kV

Isolation:

Isolation	Input	Output	Enclosure
Input	NA	2xU+1KV	2xU+1KV
Output	2xU+1KV	NA	2xU+1KV
Enclosure	2xU+1KV	2xU+1KV	NA



© 2014 Koninklijke Philips N.V. All rights reserved.
Philips reserves the right to make changes in specifications and/or to discontinue any product at any time without notice or obligation and will not be liable for any consequences resulting from the use of this publication.
philips.com/leddrivers



Philips Lighting North America Corporation
10275 W. Higgins Road, Rosemont IL 60018
Tel: 800-322-2086 Fax: 888-423-1882
Customer/Technical Service: 800-372-3331
OEM Support: 866-915-5886

Imported by: Philips Lighting
A division of Philips Electronics Ltd.
281 Hillmount Rd, Markham, ON, Canada L6C 2S3
Tel. 800-668-9008