



AR111 18.5W

OUTPUT RANGE: VIVID SERIES	930 - 1040 lumen
OUTPUT RANGE: BRILLIANT SERIES	1190 - 1280 lumen
BEAM ANGLE RANGE	9°, 25°, 36°
COLOR TEMPERATURE RANGE	2700K, 3000K, 4000K
APPLICATION	Halogen replacement for indoor & outdoor applications



POINT SOURCE OPTICS

Exceptional beam control enables unique 9° narrow spot and smooth uniform beams

Single light source, single crisp shadow

VP₃ VIVID COLOR AND VP₃ NATURAL WHITE

VIVID series provides accurate color rendering across the visible spectrum from 400nm to 700nm, with CRI/95, R9/95, Rf/90, Rg/100

Whiteness rendering matches or exceeds that of halogen and incandescent sources at 2700K and 3000K

ENERGY EFFICIENCY AND LONG LIFE

85% more energy efficient than standard halogen lamps

Typical payback of one year or less

Rated lifetime to L70: 35,000hrs

Warranty: 3yrs or 25,000hrs whichever comes first

Detailed warranty information available at sora.com/resources/legal

CERTIFICATIONS

UL/CUL Class 2 and non-Class 2, FCC Title 47 Part 15B, RoHS, CE



RoHS

HIGHLY COMPATIBLE

Narrow spot compatible with Soraa SNAP System accessories

Thermally and geometrically compatible with standard fixtures and suitable for damp locations

Suitable for fully enclosed fixtures. Can be used with front glass cover

Works with trailing edge and leading edge phase cut dimmers, 12V AC magnetic and electronic transformers and 12V DC transformers (see www.sora.com/resources)

INTENDED USE AND APPLICATIONS

Intended for use in AR111 compatible recessed downlights, track lighting and other indoor and outdoor applications

Soraa lamps are designed to safely turn down in any thermal environment not conducive to minimum airflow or proper ventilation

GENERAL SPECIFICATIONS

Form Factor

Width: 111mm (4.37")

Height: 57mm (2.24")

Weight: 250g

Operating Temperature

Minimum: -40°C (ambient)

Typical: 70°C - 80°C (base)

Maximum: 90°C (base)

Electrical

Wattage: 18.5W

Power factor: 0.92

Voltage: 12V +/- 1.2V

Frequency: 50/60Hz

Dimming and Flicker

Dimmable to <20%

Flicker Index < 0.1

Percent Flicker: 28%

DIMENSIONS

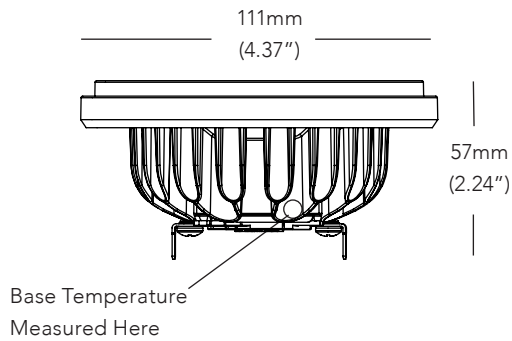

COLOR RENDERING

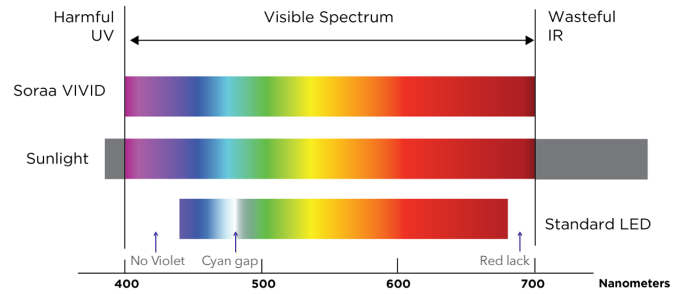

9 DEGREE BEAM

Beam Dia at 50% CBCP (ft)	Field Dia at 10% CBCP (ft)	Foot-candles (% of CBCP)
0.5	0.8	8.6%
0.9	1.7	2.5%
1.4	2.5	1.2%
1.9	3.4	0.7%
2.4	4.2	0.4%

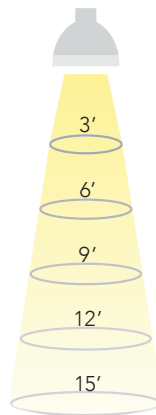

25 DEGREE BEAM

Beam Dia at 50% CBCP (ft)	Field Dia at 10% CBCP (ft)	Foot-candles (% of CBCP)
1.3	2.2	8.6%
2.7	4.4	2.5%
4.0	6.6	1.2%
5.3	8.7	0.7%
6.7	10.9	0.4%

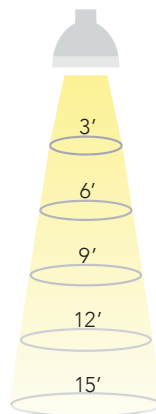

36 DEGREE BEAM

Beam Dia at 50% CBCP (ft)	Field Dia at 10% CBCP (ft)	Foot-candles (% of CBCP)
1.9	3.5	8.6%
3.9	6.9	2.5%
5.8	10.4	1.2%
7.8	13.9	0.7%
9.7	17.3	0.4%

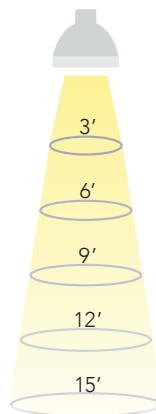

Note: Footcandles may be calculated by multiplying the CBCP of the desired model number by the percentage in the tables above

SPECIFICATIONS BY MODEL NUMBER* SORAA LED AR111 18.5W

Model #	Product Code	CCT (K)	Beam Angle	Field Angle	CBCP (Cd)	Halogen Equivalent	Total Flux (Lm)	Efficacy (Lm/W)	McA	SNAP
VIVID SERIES										
SR111-18-09D-927-03	00869	2700	9	16	22400	75	930	50	3	YES
SR111-18-25D-927-03	00871	2700	25	40	5020	75	930	50	3	-
SR111-18-36D-927-03	00873	2700	36	60	2320	75	930	50	3	-
SR111-18-09D-930-03	00885	3000	9	16	24100	75	1000	54	3	YES
SR111-18-25D-930-03	00887	3000	25	40	5400	75	1000	54	3	-
SR111-18-36D-930-03	00889	3000	36	60	2500	75	1000	54	3	-
SR111-18-09D-940-03	00901	4000	9	16	25060	75	1040	56	4	YES
SR111-18-25D-940-03	00903	4000	25	40	5600	75	1040	56	4	-
SR111-18-36D-940-03	00905	4000	36	60	2600	75	1040	56	4	-
BRILLIANT SERIES										
SR111-18-09D-827-03	00877	2700	9	16	28660	100	1190	64	3	YES
SR111-18-25D-827-03	00879	2700	25	40	6420	100	1190	64	3	-
SR111-18-36D-827-03	00881	2700	36	60	2960	100	1190	64	3	-
SR111-18-09D-830-03	00893	3000	9	16	30840	100	1280	69	3	YES
SR111-18-25D-830-03	00895	3000	25	40	6900	100	1280	69	3	-
SR111-18-36D-830-03	00897	3000	36	60	3200	100	1280	69	3	-

CCT: Correlated Color Temperature **McA:** White Point Accuracy in McA step **SNAP:** SORAA SNAP System Compatible

*Specifications are at stable warm operating conditions (25°C ambient)

SERIES/CCT

COLOR ACCURACY

WHITENESS INDEX

SPECTRAL POWER DISTRIBUTION

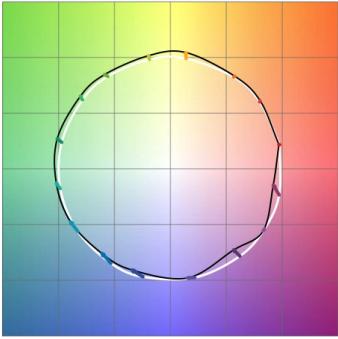
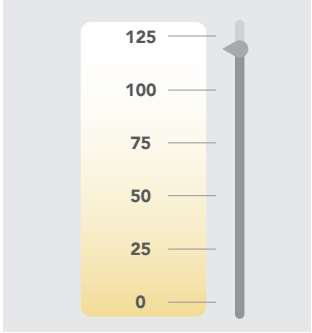
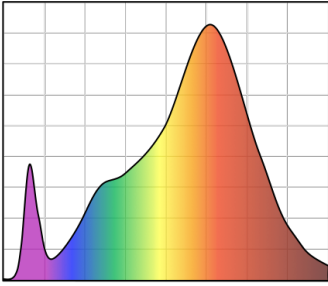
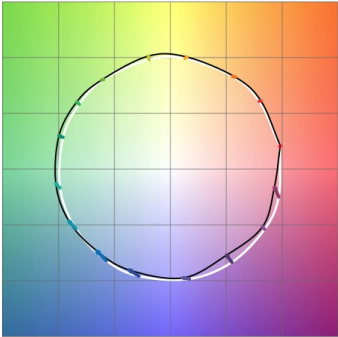
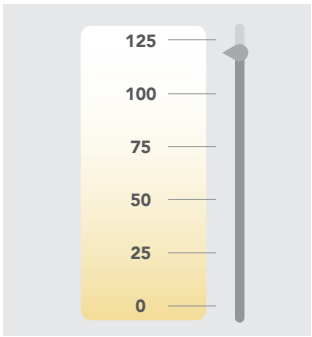
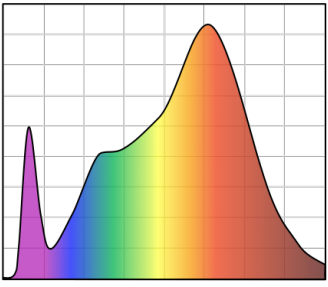
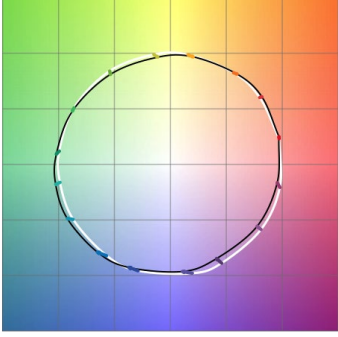
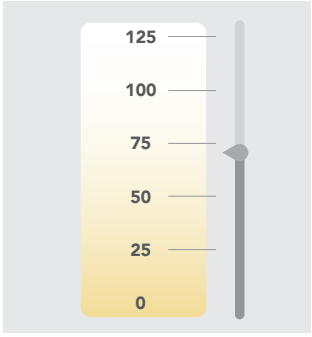
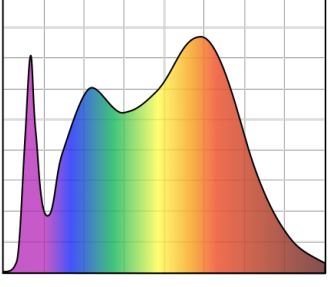
<p>VIVID 2700K</p>	 <p>Rf: 90, Rg: 100, Rfh1: 95</p>	 <p>Rw: 120</p>	 <p>380 Wavelength (nm) 780</p> <p>CRI: 95, R9: 95</p>
<p>VIVID 3000K</p>	 <p>Rf: 90, Rg: 100, Rfh1: 95</p>	 <p>Rw: 120</p>	 <p>380 Wavelength (nm) 780</p> <p>CRI: 95, R9: 95</p>
<p>VIVID 4000K</p>	 <p>Rf: 90, Rg: 100, Rfh1: 95</p>	 <p>Rw: 70</p>	 <p>380 Wavelength (nm) 780</p> <p>CRI: 95, R9: 95</p>

SERIES/CCT

COLOR ACCURACY

WHITENESS INDEX

SPECTRAL POWER DISTRIBUTION

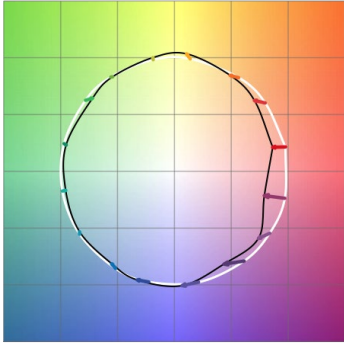
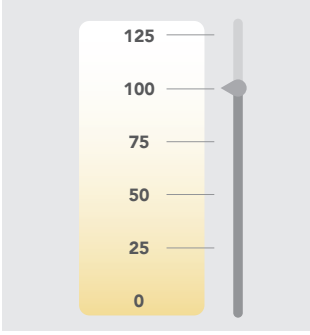
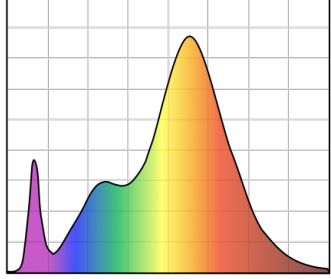
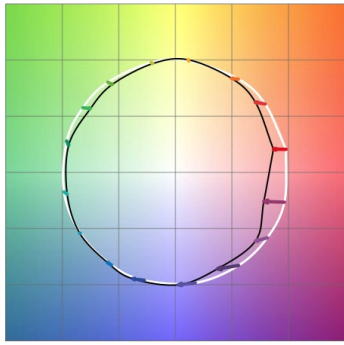
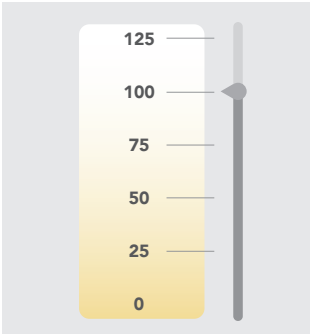
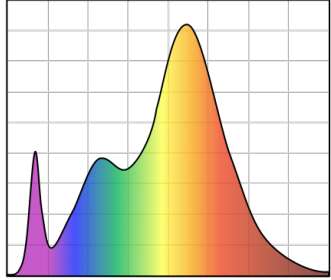
<p>BRILLIANT 2700K</p>	 <p>Rf: 85, Rg: 92, Rfh1: 77</p>	 <p>Rw: 100</p>	 <p>Wavelength (nm) 380 780</p> <p>CRI: 85, R9: >0</p>
<p>BRILLIANT 3000K</p>	 <p>Rf: 85, Rg: 92, Rfh1: 77</p>	 <p>Rw: 100</p>	 <p>Wavelength (nm) 380 780</p> <p>CRI: 85, R9: >0</p>

Rf: TM-30 metric measuring color fidelity (whether colors are similar to those under natural light). Rf is a more accurate version of the CRI Ra. Rf is 100 for natural light.
 Rg: TM-30 metric measuring color gamut (whether colors are more saturated than under natural light). Rg is 100 for natural light.
 Rfh1: TM-30 metric measuring color fidelity for red tones. Rfh1 is a more accurate version of the CRI R9. Rfh1 is 100 for natural light.
 Rw: Soraa-developed metric to measure white fidelity. Rw measures the magnitude of excitation of whitening agents within whites. Rw is about 100 for natural light.