

PAR30S 18.5W



OUTPUT RANGE: VIVID SERIES	930 - 1040 lumen
OUTPUT RANGE: BRILLIANT SERIES	1190 - 1280 lumen
BEAM ANGLE RANGE	9°, 25°, 36°, 60°
COLOR TEMPERATURE RANGE	2700K, 3000K, 4000K
APPLICATION	Halogen replacement for indoor & outdoor applications



POINT SOURCE OPTICS

Exceptional beam control enables unique 9° narrow spot and smooth uniform beams

Single light source, single crisp shadow

VP₃ VIVID COLOR AND VP₃ NATURAL WHITE

VIVID series provides accurate color rendering across the visible spectrum from 400nm to 700nm, with CRI/95, R9/95, Rf/90, Rg/100

Whiteness rendering matches or exceeds that of halogen and incandescent sources at 2700K and 3000K

ENERGY EFFICIENCY AND LONG LIFE

85% more energy efficient than standard halogen lamps

Typical payback of one year or less

Rated lifetime to L70: 35,000hrs

Warranty: 3yrs or 25,000hrs whichever comes first

Detailed warranty information available at soraa.com/resources/legal

CERTIFICATIONS

RoHS, CE, UL/CUL, FCC Title 47 Part 15B



HIGHLY COMPATIBLE

Narrow spot compatible with Soraa SNAP System accessories

Thermally and geometrically compatible with standard fixtures and suitable for damp locations

Suitable for fully enclosed fixtures. Can be used with front glass cover

Works with trailing edge and leading edge phase cut dimmers (see www.soraa.com/resources)

INTENDED USE AND APPLICATIONS

Intended for use in PAR30S compatible recessed downlights, track lighting and other indoor and outdoor applications

Soraa lamps are designed to safely turn down in any thermal environment not conducive to minimum airflow or proper ventilation

GENERAL SPECIFICATIONS

Form Factor	Operating Temperature	Electrical	Dimming and Flicker
Width: 96mm (3.78")	Minimum: -40°C (ambient)	Wattage: 18.5W	Dimmable to <20%
Height: 82mm (3.23")	Typical: 70°C - 80°C (base)	Power factor: 0.95	Flicker Index: <0.1
Weight: 269g	Maximum: 90°C (base)	Voltage: 120V +/- 12V	Percent Flicker: 28%*
		Frequency: 50/60Hz	

* These Soraa lamps are certified to California's demanding JA8 standard, which requires <30% flicker

DIMENSIONS

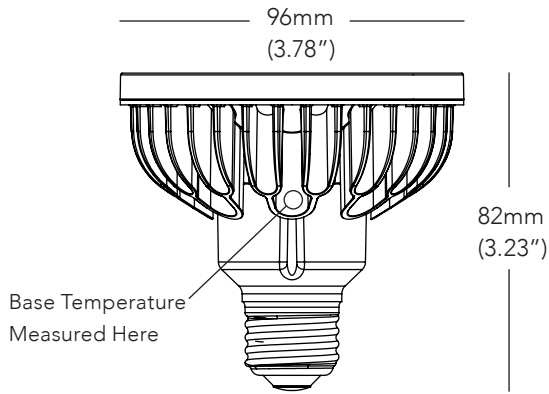

COLOR RENDERING

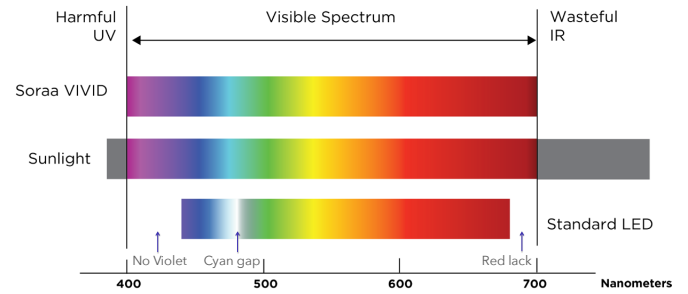

9 DEGREE BEAM

Beam Dia at 50% CBCP (ft)	Field Dia at 10% CBCP (ft)	Foot-candles (% of CBCP)
0.5	0.8	8.6%
0.9	1.7	2.5%
1.4	2.5	1.2%
1.9	3.4	0.7%
2.4	4.2	0.4%

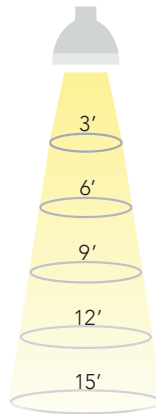

25 DEGREE BEAM

Beam Dia at 50% CBCP (ft)	Field Dia at 10% CBCP (ft)	Foot-candles (% of CBCP)
1.3	2.2	8.6%
2.7	4.4	2.5%
4.0	6.6	1.2%
5.3	8.7	0.7%
6.7	10.9	0.4%

60 DEGREE BEAM

Beam Dia at 50% CBCP (ft)	Field Dia at 10% CBCP (ft)	Foot-candles (% of CBCP)
1.9	3.5	8.6%
3.9	6.9	2.5%
5.8	10.4	1.2%
7.8	13.9	0.7%
9.7	17.3	0.4%

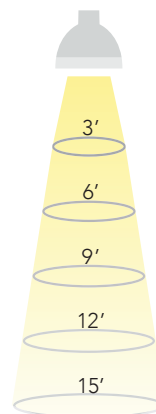

Beam Dia at 50% CBCP (ft)	Field Dia at 10% CBCP (ft)	Foot-candles (% of CBCP)
3.5	6.0	8.6%
6.9	12.0	2.5%
10.4	18.0	1.2%
13.9	24.0	0.7%
17.3	30.0	0.4%

Note: Footcandles may be calculated by multiplying the CBCP of the desired model number by the percentage in the tables above

SPECIFICATIONS BY MODEL NUMBER* SORAA LED PAR30S 18.5W

Model #	Product Code	CCT (K)	Beam Angle	Field Angle	CBCP (Cd)	Halogen Equivalent	Total Flux (Lm)	Efficacy (Lm/W)	McA	JA8-2016	SNAP
VIVID SERIES											
SP30S-18-09D-927-03	00821	2700	9	16	17200	100	930	50	3	YES	YES
SP30S-18-25D-927-03	00823	2700	25	40	5020	100	930	50	3	YES	-
SP30S-18-36D-927-03	00825	2700	36	60	2320	100	930	50	3	YES	-
SP30S-18-60D-927-03	00827	2700	60	90	1020	100	930	50	3	YES	-
SP30S-18-09D-930-03	00837	3000	9	16	18500	100	1000	54	3	YES	YES
SP30S-18-25D-930-03	00839	3000	25	40	5400	100	1000	54	3	YES	-
SP30S-18-36D-930-03	00841	3000	36	60	2500	100	1000	54	3	YES	-
SP30S-18-60D-930-03	00843	3000	60	90	1100	100	1000	54	3	YES	-
SP30S-18-09D-940-03	00853	4000	9	16	19240	100	1040	56	4	NA	YES
SP30S-18-25D-940-03	00855	4000	25	40	5600	100	1040	56	4	NA	-
SP30S-18-36D-940-03	00857	4000	36	60	2600	100	1040	56	4	NA	-
SP30S-18-60D-940-03	00859	4000	60	90	1140	100	1040	56	4	NA	-
BRILLIANT SERIES											
SP30S-18-09D-827-03	00829	2700	9	16	22000	120	1190	64	3	NA	YES
SP30S-18-25D-827-03	00831	2700	25	40	6420	120	1190	64	3	NA	-
SP30S-18-36D-827-03	00833	2700	36	60	2960	120	1190	64	3	NA	-
SP30S-18-60D-827-03	00835	2700	60	90	1300	120	1190	64	3	NA	-
SP30S-18-09D-830-03	00845	3000	9	16	23680	120	1280	69	3	NA	YES
SP30S-18-25D-830-03	00847	3000	25	40	6900	120	1280	69	3	NA	-
SP30S-18-36D-830-03	00849	3000	36	60	3200	120	1280	69	3	NA	-
SP30S-18-60D-830-03	00851	3000	60	90	1400	120	1280	69	3	NA	-

CCT: Correlated Color Temperature **McA:** White Point Accuracy in McA step **SNAP:** SORAA SNAP System Compatible

*Specifications are at stable warm operating conditions (25°C ambient)

SERIES/CCT

COLOR ACCURACY

WHITENESS INDEX

SPECTRAL POWER DISTRIBUTION

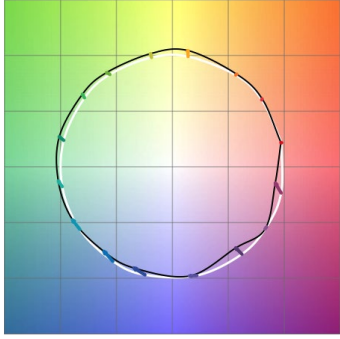
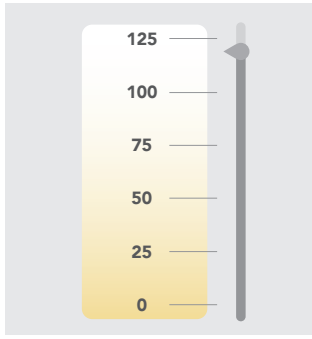
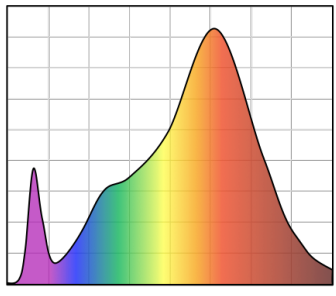
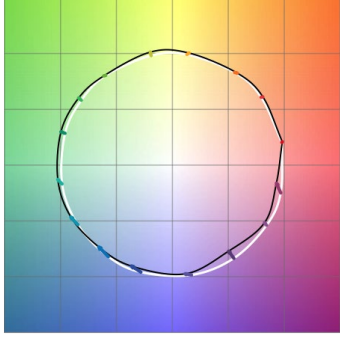
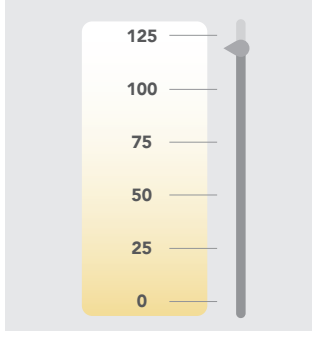
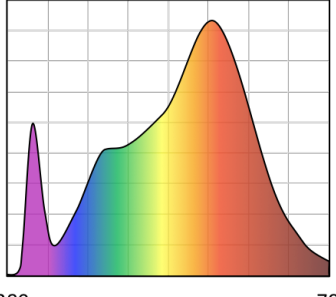
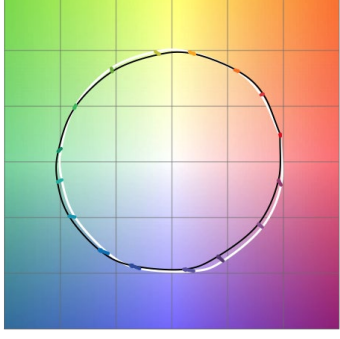
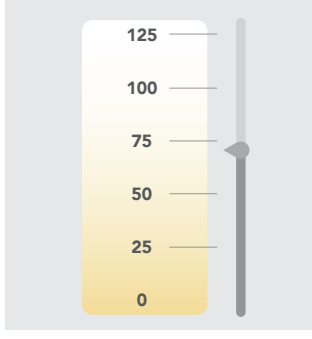
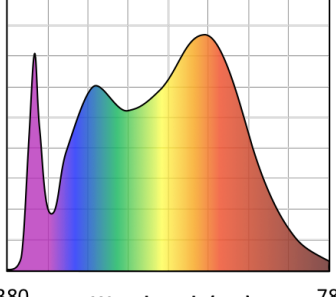
<p>VIVID 2700K</p>	 <p>Rf: 90, Rg: 100, Rfh1: 95</p>	 <p>Rw: 120</p>	 <p>380 Wavelength (nm) 780</p> <p>CRI: 95, R9: 95</p>
<p>VIVID 3000K</p>	 <p>Rf: 90, Rg: 100, Rfh1: 95</p>	 <p>Rw: 120</p>	 <p>380 Wavelength (nm) 780</p> <p>CRI: 95, R9: 95</p>
<p>VIVID 4000K</p>	 <p>Rf: 90, Rg: 100, Rfh1: 95</p>	 <p>Rw: 70</p>	 <p>380 Wavelength (nm) 780</p> <p>CRI: 95, R9: 95</p>