

# PAR20 5.4W



---

<b>OUTPUT RANGE: VIVID SERIES</b>	245 - 265 lumen
<b>OUTPUT RANGE: BRILLIANT SERIES</b>	315 - 335 lumen
<b>BEAM ANGLE RANGE</b>	8°, 25°, 36°
<b>COLOR TEMPERATURE RANGE</b>	2700K, 3000K
<b>APPLICATION</b>	Halogen replacement for indoor & outdoor applications

---



## POINT SOURCE OPTICS

Exceptional beam control enables unique 8° narrow spot and smooth uniform beams

Single light source, single crisp shadow

## VP<sub>3</sub> VIVID COLOR & VP<sub>3</sub> NATURAL WHITE

VIVID series provides accurate color rendering across the visible spectrum from 400nm to 700nm, with CRI/95, R9/95, Rf/90, Rg/100

Whiteness rendering matches or exceeds that of halogen and incandescent sources at 2700K and 3000K

## ENERGY EFFICIENCY & LONG LIFE

85% more energy efficient than standard halogen lamps

Typical payback of one year or less

Rated lifetime of 35,000 hours. 3 year warranty

## CERTIFICATIONS

RoHS, CE, UL/CUL, FCC Title 47 Part 15B



## HIGHLY COMPATIBLE

Narrow spot compatible with Soraa SNAP System accessories

Thermally and geometrically compatible with standard fixtures and suitable for damp locations

Works with trailing edge and leading edge phase cut dimmers

## INTENDED USE AND APPLICATIONS

Intended for use in PAR20 compatible recessed downlights, track lighting and other indoor and outdoor applications

Soraa lamps are designed to safely turn down in any thermal environment not conducive to minimum airflow or proper ventilation

## GENERAL SPECIFICATIONS

---

Form Factor	Operating Temperature	Electrical	Dimming and Flicker
Width: 64mm (2.52")	Minimum: -40°C (ambient)	Wattage: 5.4W	Dimmable to <20%
Height: 77mm (3.04")	Typical: 60°C - 70°C (base)	Power factor: 0.92	Flicker Index: <0.10
Weight: 160g	Maximum: 80°C (base)	Voltage: 120V +/- 12V	Percent Flicker: 23%
		Frequency: 50/60Hz	

## DIMENSIONS

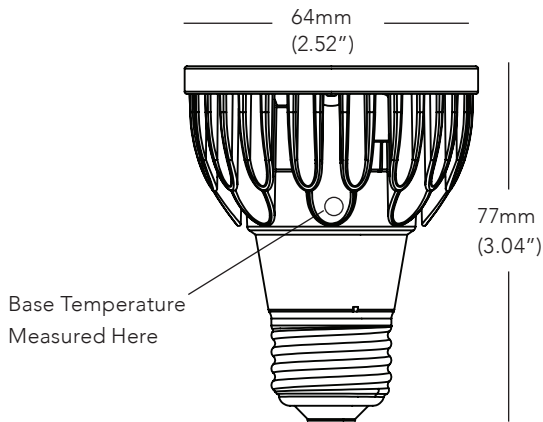

## COLOR RENDERING

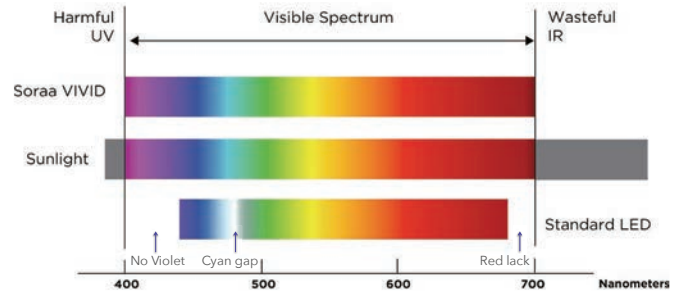

## 8 DEGREE BEAM

Beam Dia at 50% CBCP (ft)	Field Dia at 10% CBCP (ft)	Foot-candles (% of CBCP)
0.4	1.1	11.1%
0.8	2.1	2.8%
1.3	3.2	1.2%
1.7	4.2	0.7%
2.1	5.3	0.4%

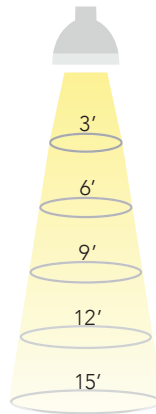

## 25 DEGREE BEAM

Beam Dia at 50% CBCP (ft)	Field Dia at 10% CBCP (ft)	Foot-candles (% of CBCP)
1.3	2.2	11.1%
2.7	4.4	2.8%
4.0	6.6	1.2%
5.3	8.7	0.7%
6.7	10.9	0.4%

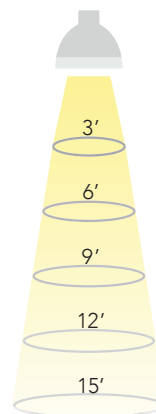

## 36 DEGREE BEAM

Beam Dia at 50% CBCP (ft)	Field Dia at 10% CBCP (ft)	Foot-candles (% of CBCP)
1.9	3.5	11.1%
3.9	6.9	2.8%
5.8	10.4	1.2%
7.8	13.9	0.7%
9.7	17.3	0.4%

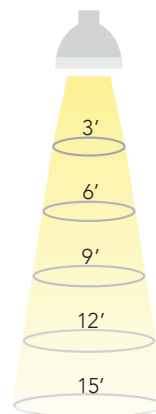

Note: Footcandles may be calculated by multiplying the CBCP of the desired model number by the percentage in the tables above

## SPECIFICATIONS BY MODEL NUMBER\* SORAA LED PAR20 5.4W

Model #	Product Code	CCT (K)	Beam Angle	Field Angle	CBCP (Cd)	Halogen Equivalent	Total Flux (Lm)	Efficacy (Lm/W)	McA	Energy Star	SNAP
<b>VIVID SERIES</b>											
SP20-05-08D-927-03	01659	2700	8	20	6360	50	245	45	3	-	YES
SP20-05-25D-927-03	01951	2700	25	40	1280	50	245	45	3	-	-
SP20-05-36D-927-03	01953	2700	36	60	600	50	245	45	3	-	-
SP20-05-08D-930-03	01661	3000	8	20	6880	50	265	49	3	-	YES
SP20-05-25D-930-03	01955	3000	25	40	1400	50	265	49	3	-	-
SP20-05-36D-930-03	01957	3000	36	60	660	50	265	49	3	-	-
<b>BRILLIANT SERIES</b>											
SP20-05-08D-827-03	01647	2700	8	20	8180	60	315	58	3	-	YES
SP20-05-25D-827-03	01649	2700	25	40	1660	60	315	58	3	-	-
SP20-05-36D-827-03	01651	2700	36	60	780	60	315	58	3	-	-
SP20-05-08D-830-03	01653	3000	8	20	8700	60	335	62	3	-	YES
SP20-05-25D-830-03	01655	3000	25	40	1760	60	335	62	3	-	-
SP20-05-36D-830-03	01657	3000	36	60	820	60	335	62	3	-	-

**CCT:** Correlated Color Temperature **McA:** White Point Accuracy in McA step **SNAP:** SORAA SNAP System Compatible

\*Specifications are at stable warm operating conditions (25°C ambient)

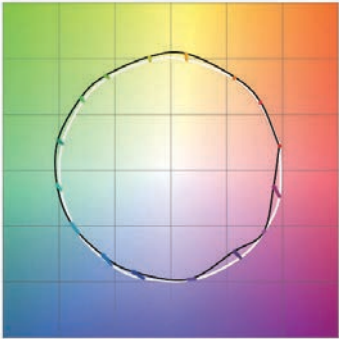
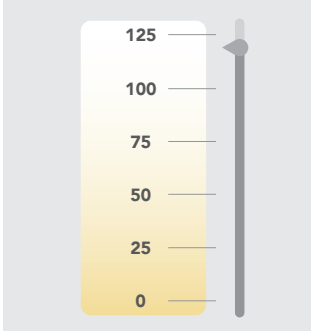
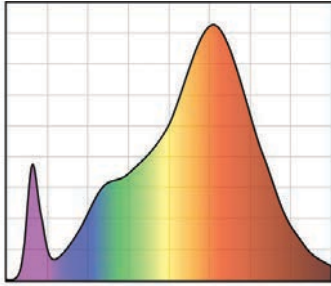
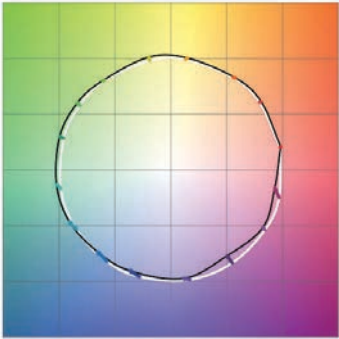
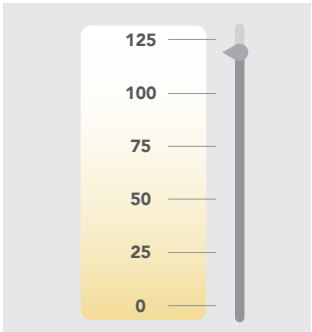
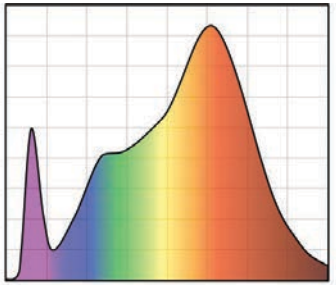
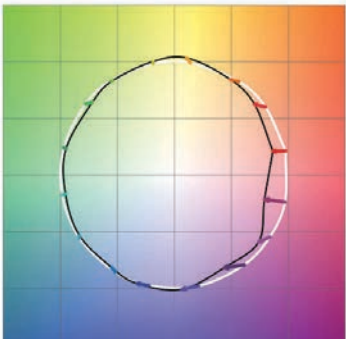
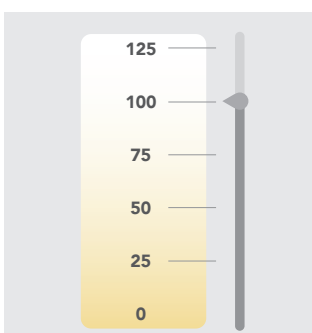
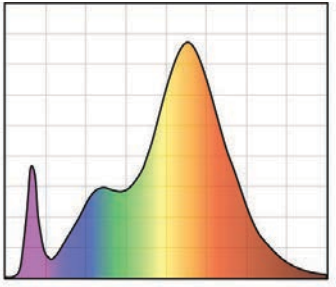
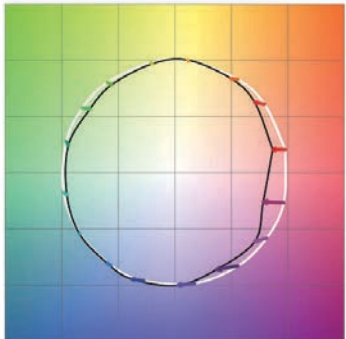
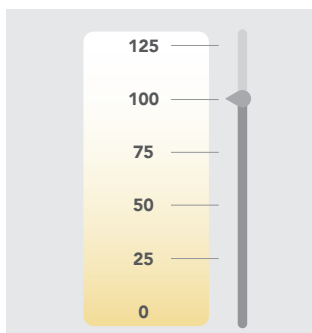
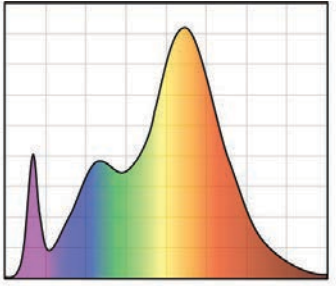
SERIES/CCT	COLOR ACCURACY	WHITENESS INDEX	SPECTRAL POWER DISTRIBUTION
<b>VIVID 2700K</b>	 <b>Rf: 90, Rg: 100, Rfh1: 95</b>	 <b>Rw: 120</b>	 <b>CRI: 95, R9: 95</b>
<b>VIVID 3000K</b>	 <b>Rf: 90, Rg: 100, Rfh1: 95</b>	 <b>Rw: 120</b>	 <b>CRI: 95, R9: 95</b>
<b>BRILLIANT 2700K</b>	 <b>Rf: 85, Rg: 92, Rfh1: 77</b>	 <b>Rw: 100</b>	 <b>CRI: 85, R9: &gt;0</b>
<b>BRILLIANT 3000K</b>	 <b>Rf: 85, Rg: 92, Rfh1: 77</b>	 <b>Rw: 100</b>	 <b>CRI: 85, R9: &gt;0</b>

Rf: TM-30 metric measuring color fidelity (whether colors are similar to those under natural light). Rf is a more accurate version of the CRI Ra. Rf is 100 for natural light.  
Rg: TM-30 metric measuring color gamut (whether colors are more saturated than under natural light). Rg is 100 for natural light.  
Rfh1: TM-30 metric measuring color fidelity for red tones. Rfh1 is a more accurate version of the CRI R9. Rfh1 is 100 for natural light.  
Rw: Soraa-developed metric to measure white fidelity. Rw measures the magnitude of excitation of whitening agents within whites. Rw is about 100 for natural light.