

Maestro® Dual Technology Sensor Switch

The Maestro® Dual Technology (Dual Tech) Occupancy Sensor Switch applies our exclusive XCT™ Technology to the ultrasonic as well as the passive infrared technology in this sensor to create a product that can detect very fine motion, such as typing. This product also includes all of the great features found in the rest of the Maestro® sensor family, including: adaptive relay switching, smart ambient light detection, and simple button presses for changing settings. The Maestro® Dual Tech Occupancy Sensor Switch is available in single-circuit and dual-circuit versions.

The single-circuit versions (MS-A102, MS-B102) can be used to meet many of the Title 20/24, ASHRAE 90.1, and IECC code requirements such as “automatic shutoff”. The dual-circuit versions (MS-A202, MS-B202) can be used to meet many of the Title 20/24, ASHRAE 90.1, and IECC code requirements such as “automatic shutoff” and “multi-level lighting control”. To find some examples of code-specific applications, visit www.lutron.com/energycodes

Features

- XCT™ Technology for major, minor, fine, and very fine motion detection
- 180° sensor field-of-view
- Tamper-resistant PIR lens
- Up to 900 ft² (81 m²) major motion coverage and 400 ft² (36 m²) minor motion coverage
- Two Ambient Light Detect (ALD) options:
 - Learning ALD Mode:
 - Uses adaptive algorithm.
 - Sensor learns user’s preferred light level over time.
 - Fixed ALD mode:
 - Four selectable light level thresholds: Hi, Med, Low, Min
- Occupancy models (MS-A102-XX, MS-B102-XX, MS-A202-XX, MS-B202-XX) can be set to Auto-ON/Auto-OFF or Manual-ON/Auto-OFF per circuit
- Dual-circuit models (MS-A202, MS-B202) meet Title 24 requirements for multi-level lighting control.
- Single-circuit “Vacancy” models (MS-A102-V-XX, MS-B102-V-XX) available to meet Title 24/Title 20 requirements for vacancy sensors.
- Adjustable timeout for each circuit (1, 5, 15, or 30 minutes)
- Sensitivity adjustment
 - PIR (Hi, Med, Low, Min)
 - Ultrasonic (Hi, Med, Low, Off)
- Switches all lighting loads: incandescent, halogen, ELV, MLV, CFL, LED, magnetic fluorescent, electronic fluorescent
- Switches fan loads at 120 V~
- MS-B102, MS-B102-V work with Maestro® accessory switches in multi-location applications
- MS-A models DO NOT require neutral wiring, while the MS-B models DO require neutral wiring.

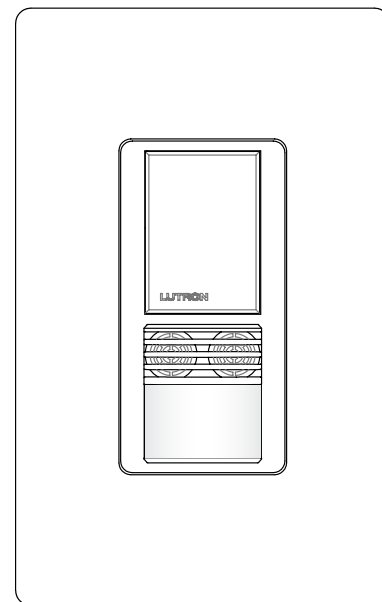

MS-A102-XX (Occupancy model)
 MS-A102-V-XX (Vacancy model)
 MS-B102-XX (Occupancy model)
 MS-B102-V-XX (Vacancy model)

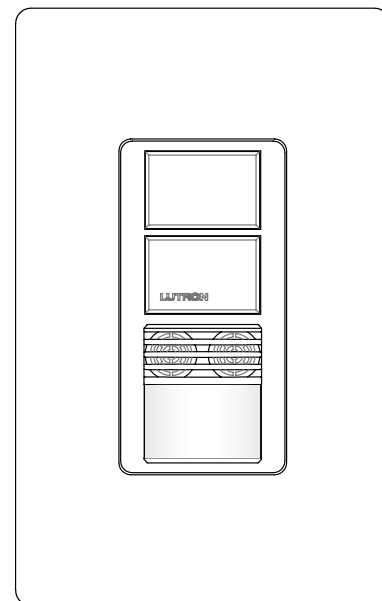

MS-A202-XX (Occupancy model)
 MS-B202-XX (Occupancy model)

Notes:

- “XX” in the model number represents color/finish code. See **Colors and Finishes** at end of document.
- Wallplate not included.

Job Name:	Model Numbers:	
<input type="text"/>	<input type="text"/>	<input type="text"/>
Job Number:	<input type="text"/>	<input type="text"/>

Specifications

Regulatory Approvals

- UL® Listed to U.S. and Canadian safety requirements (applies only to MS-B102, MS-B102-V, MS-B202)
- NOM certified
- Title 20/24 certified lighting control device
 - Complies with Title 20 and Title 24 section 110.9

Power/Load Control

- 120–277 V~ 50/60 Hz

Key Design Features

- Dual Sensing Technology
- Switches all lighting loads
- 6 A of lighting load per circuit at 120–277 V~
- 4.4 A (1/6 HP) of fan load per circuit at 120 V~
- Crush/tamper resistant lens
- Smart Ambient Light Detection (ALD)
- Fixed Ambient Light Detection
- Adaptive zero-cross switching algorithm for extended relay life (patent pending)
- XCT™ Technology for major, minor, fine, and very fine motion detection
- Programmable Circuit Swapping eliminates need for rewiring to reassign circuits after installation of a dual-circuit product. (patent pending)
- Product ground current does not exceed 0.5 mA

Environment

- Ambient operating temperature: 32 °F to 104 °F (0 °C to 40 °C), 0%–90% humidity, non-condensing. Indoor use only.

Warranty

- 5-Year Limited Warranty. For additional Warranty information, please visit www.lutron.com/TechnicalDocumentLibrary/Sensor_Warranty.pdf

Sensor Detection

Lutron® Dual Tech sensors operate by triggering initial occupancy using PIR technology, and maintain occupancy using both ultrasonic and PIR technology.

Advanced Features

Switching

- Adaptive zero-cross switching—maximizes relay life by switching at the point of minimum energy on the AC power curve (patent pending). Actively adapts to variations in relay timing.

Additional Information on Sensors

- For single-circuit PIR Maestro® Occupancy Sensor Switch models, please see Lutron® P/N 369666
- For Maestro® Occupancy Sensor C•L® Dimmer models, please see Lutron® P/N 369748
- For dual-circuit PIR Maestro Occupancy Sensor Switch, please see Lutron® P/N 369758
- For more information, please see www.lutron.com/occvacsensors
- Lutron Technical Hotline: 1.800.523.9466.

Job Name: <input style="width: 90%; height: 20px;" type="text"/>	Model Numbers: <input style="width: 95%; height: 20px;" type="text"/>	
Job Number: <input style="width: 80%; height: 20px;" type="text"/>	<input style="width: 95%; height: 20px;" type="text"/>	<input style="width: 95%; height: 20px;" type="text"/>

Custom Settings

Default settings shown in bold

- Timeout

- 30 min
- **15 min**
- 5 min
- 1 min

Mode - Sensor Modes

Lights automatically turn off in all sensor modes

- **Occ -Occupancy mode (No ALD)**^{1,2,3}
- Lrn - Occupancy with learning ALD mode
- Fixd - Occupancy with fixed ALD mode
- Vac - Vacancy mode (No ALD)^{2,3}

¹ MS-A102-XX, MS-B102-XX default is Occ
² MS-A102-V-XX, MS-B102-V-XX is locked as Vac
³ MS-A202-XX, MS-B202-XX defaults are: Circuit 1 - Occ, Circuit 2 - Vac

- Ultrasonic Sensitivity

- High
- **Med**
- Low
- Off

PIR - Passive Infrared Sensitivity

- **High**
- Med
- Low
- Min

Additional Settings

Fixed ALD Light Level

- Hi
- Med
- **Low***
- Min

* "Low" is the default setting for any sensor that is set by the user to: Occupancy with fixed ALD mode

Off-While-Occupied

- **Enabled**
- Disabled

Walk-Thru Mode

- Enabled
- **Disabled**

Custom Settings - Details

Ambient Light Detection (ALD) mode

Lights turn on only when natural light in the room is below the set threshold.

- **Learning:** The ambient light threshold adjusts to the user's preference via manual interaction with the sensor switch.
- **Fixed:** Choose a fixed ALD light level from four pre-set options: High, Medium, Low, and Minimum

Manual Off-While-Occupied Options

ENABLED (default setting)

- When the sensor switch is manually turned off, the sensor switch will not turn the lights back on automatically while the room is occupied.
- Once the room is vacated, the Auto-On feature returns to normal operation after the timeout period has expired.
- This may be the preference in conference rooms or classrooms while viewing presentations. This feature requires motions to keep the lights off.

DISABLED

- When the sensor switch is manually turned off, the Auto-On feature will return to normal operation after 25 seconds.
- This may be the preference in a restroom if the user always wants the lights to turn on upon entering and the lights to turn off when the room is vacant.

Walk-Thru Mode

ENABLED¹

- If motion is not detected within 3 minutes after initial occupancy, the lights will turn off after 3 minutes, instead of the current timeout.
- This setting may be the preference in commercial applications where personnel may briefly trigger sensors during non-working hours.

DISABLED (default setting)

- When motion is detected, the lights will ALWAYS remain on for the entire timeout duration, regardless of the duration of occupancy detection.

¹ 1 minute timeout would be overridden if walk-thru mode is also ENABLED

Job Name:	Model Numbers:	
<input type="text"/>	<input type="text"/>	<input type="text"/>
Job Number:	<input type="text"/>	<input type="text"/>

Load Type and Capacity

Control	Neutral Connection Required	Vacancy Only	Number of Circuits	Voltage / Load Type / Maximum Load (Anywhere in Gang) ¹	Minimum Load	3-Way with Mechanical Switch	Multi-Location with Accessory Switch
MS-A102			1	120 - 277 V~ Lighting 6 A ² 120 V~ Fan 4.4 A (1/6 HP) ³	0 A		
MS-A102-V		✓	1		0 A		
MS-A202			2		0 A		
MS-B102	✓		1		0 A	✓	✓
MS-B102-V	✓	✓	1		0 A	✓	✓
MS-B202	✓		2		0 A	✓	

¹ Ratings shown are per circuit.

² Sensor Switch Load Type: Designed for use with permanently installed incandescent, halogen, MLV, ELV, CFL, LED, magnetic fluorescent, and electronic fluorescent lighting loads.

³ When controlling light and fan loads simultaneously on a single-circuit, maximum load capacity per circuit is 4.4 A at 120 V~.

Sensor Switch Placement

- The sensor switch performs better with an unobstructed view of room occupants.
- Hot objects and moving air currents can affect the performance of the sensor switch. The sensor switch performs best when located 6 ft (1.8 m) or more away from hot objects or moving air currents.
- The PIR performance depends on a temperature differential between the ambient room temperature and that of room occupants. Warmer rooms may reduce the ability of the sensor switch to detect occupants.
- The ultrasonic performance can be affected by air currents and moving objects. Consider the effects of fans, HVAC vents, open windows, or moving objects when installing the sensor switch.
- If the sensor sees a specific area that is not desired (e.g., hallway), Lutron offers a lens mask kit (Lutron® P/N 50013614) that can be ordered through Tech Support (1.800.523.9466). Alternatively, selectively placing opaque tape (e.g., painter’s tape, electrical tape, masking tape) over certain parts of the lens can limit it’s field of vision to block undesired detection areas. Masking the lens may effect ALD performance, but DOES NOT block ultrasonic frequencies.

Definitions

Major motion: movement of a person entering or passing through an area.

Minor motion: movement of a person occupying an area and engaging in small activities (e.g., reaching for a telephone, turning the pages of a book, opening a file folder, picking up a coffee cup).



Fine Motion: movement of a person occupying an area and engaging in very small activities (e.g., reading a magazine).

Very Fine Motion: movement of a person occupying an area and engaging in very small activities (e.g., typing on a keyboard).

Job Name: <input style="width: 90%; height: 20px;" type="text"/>	Model Numbers: <input style="width: 95%; height: 20px;" type="text"/>	
Job Number: <input style="width: 80%; height: 20px;" type="text"/>	<input style="width: 95%; height: 20px;" type="text"/>	<input style="width: 95%; height: 20px;" type="text"/>

Sensor Switch Placement (continued)

NEMA WD7 Coverage

-  Major motion coverage: 900 ft² (81 m²)
-  Minor motion coverage: 400 ft² (36 m²)

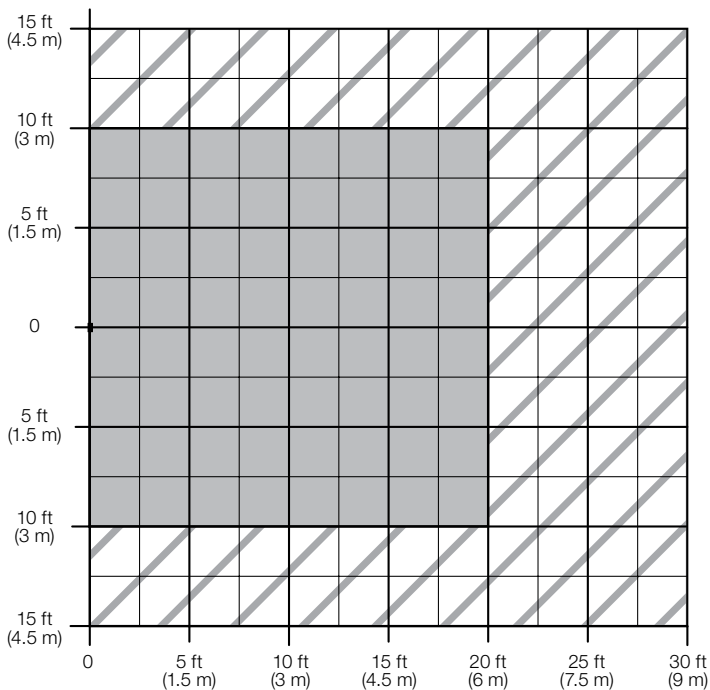

Test Room Dimensions: 37 ft x 38 ft (11.28 m x 11.6 m)
 Test Floor Surface Material: Carpet
 Sensor Coverage Angle: 180 °
 Major motion coverage: Initial trigger motion detection
 Minor motion coverage: Maintained motion detection

Passive Infrared Beam Diagram (For Reference Only)

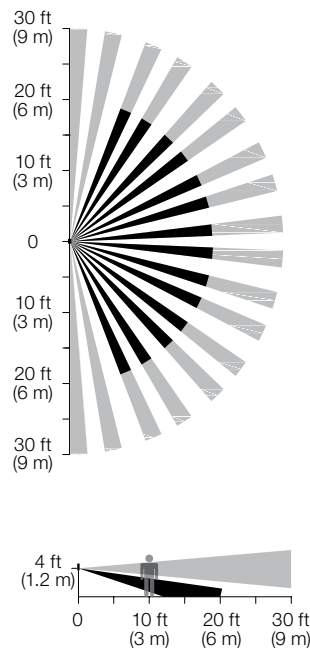

Ultrasonic Coverage (For Reference Only)

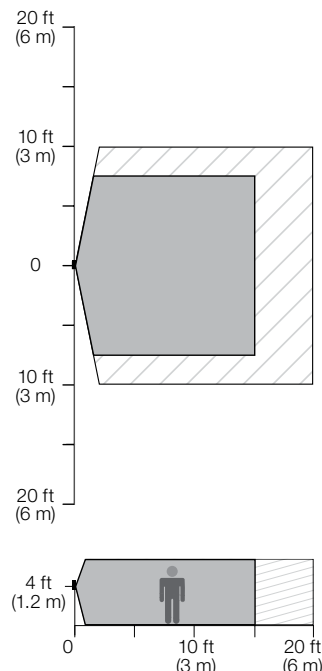

Ultrasonic Frequency: 40 kHz

Job Name:	Model Numbers:	
<input type="text"/>	<input type="text"/>	<input type="text"/>
Job Number:	<input type="text"/>	<input type="text"/>

Dimensions - Single-Circuit MS-A102, MS-A102-V, MS-B102, MS-B102-V

Measurements shown as: in (mm).

Front View

Side View

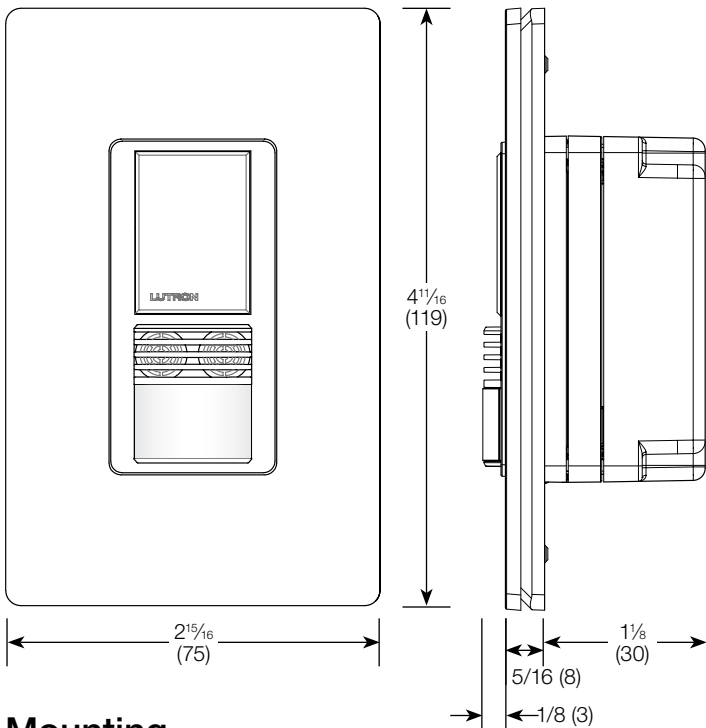

Operation

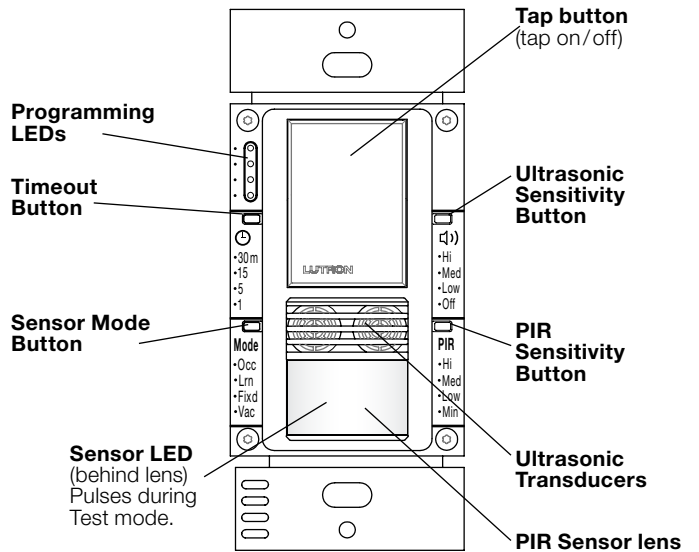

Mounting

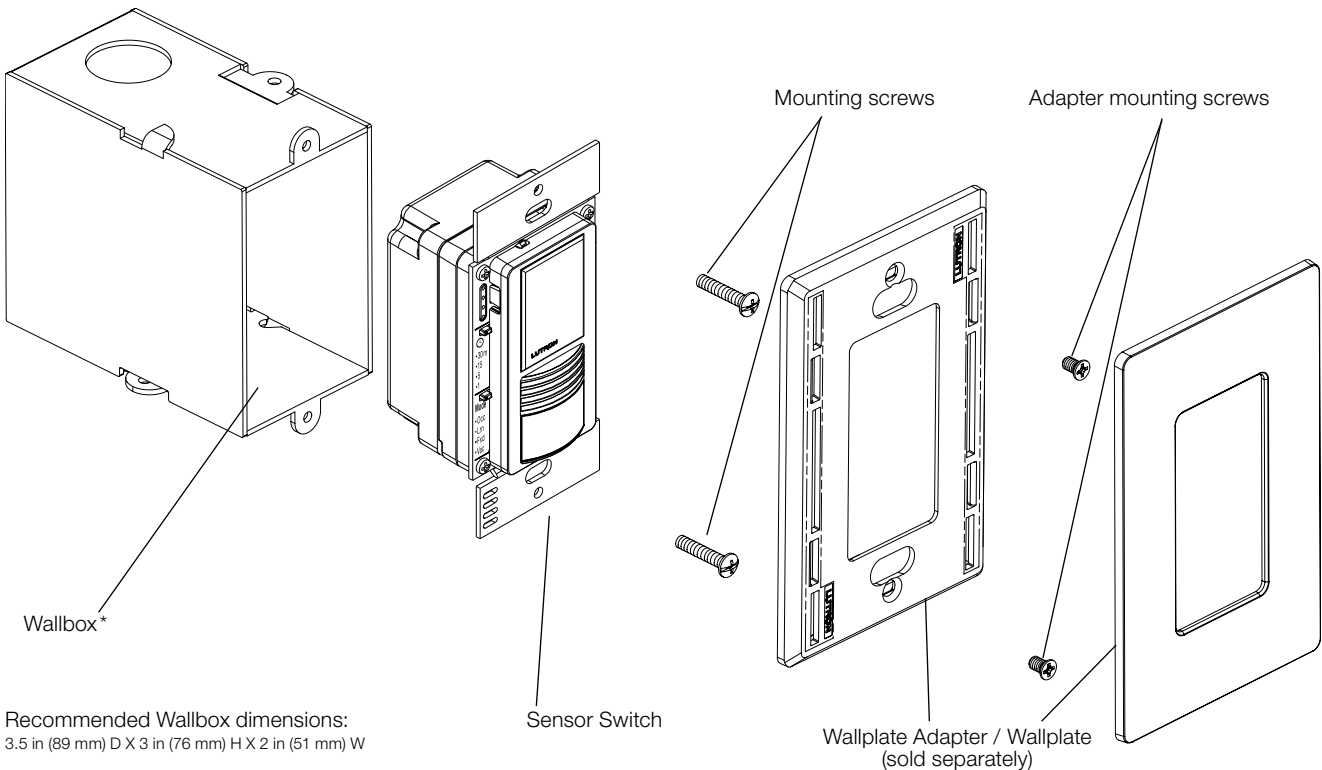

* Recommended Wallbox dimensions:
3.5 in (89 mm) D X 3 in (76 mm) H X 2 in (51 mm) W

Job Name:	Model Numbers:	
<input type="text"/>	<input type="text"/>	<input type="text"/>
Job Number:	<input type="text"/>	<input type="text"/>

Dimensions - Dual-Circuit MS-A202, MS-B202

Measurements shown as: in (mm).

Front View

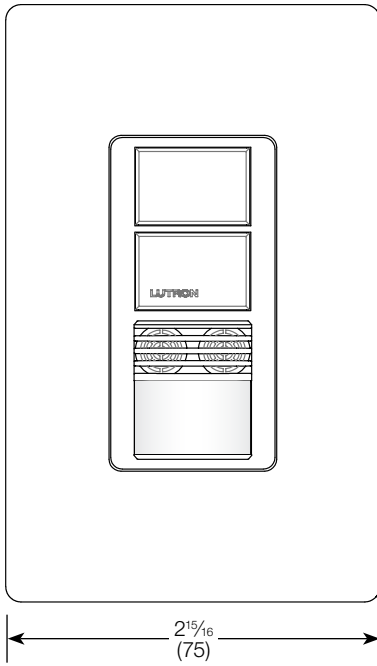

Side View

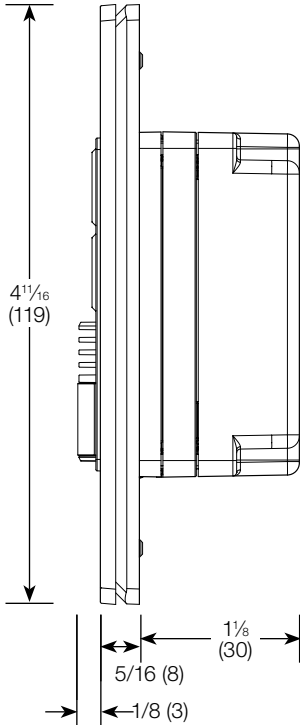

Operation

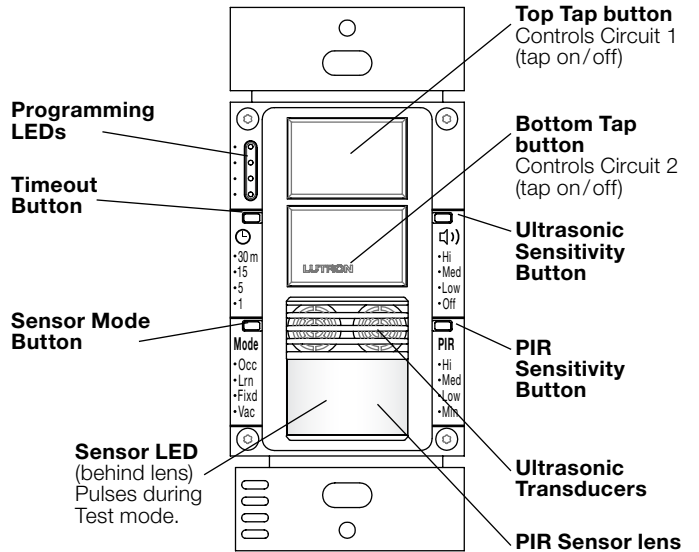

Mounting

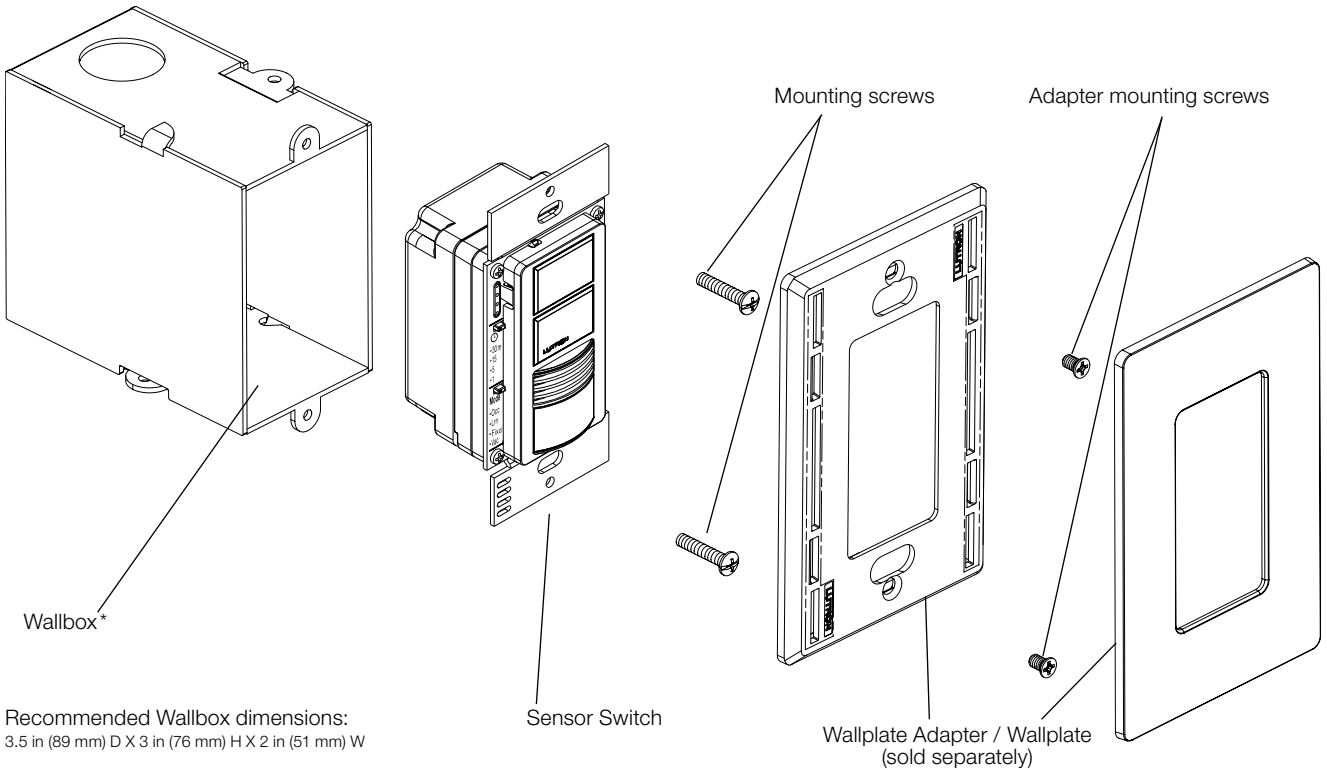

* Recommended Wallbox dimensions:
3.5 in (89 mm) D X 3 in (76 mm) H X 2 in (51 mm) W

Job Name:	Model Numbers:	
<input type="text"/>	<input type="text"/>	<input type="text"/>
Job Number:	<input type="text"/>	<input type="text"/>

Wiring Diagrams - Single-Circuit

Wiring Diagram 1

Single Pole Wiring - Single-Circuit (MS-A102, MS-A102-V)

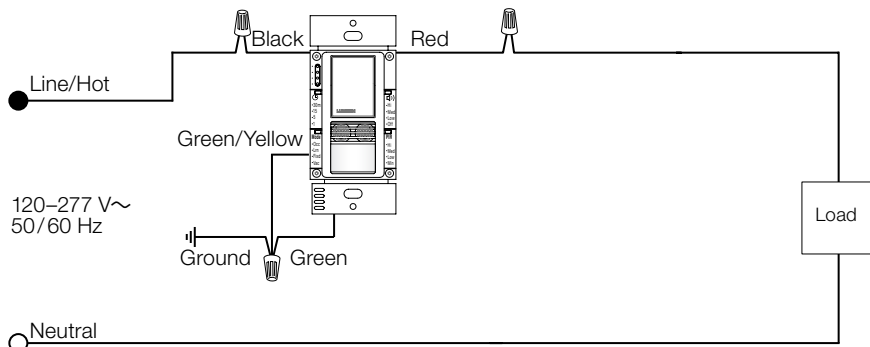

Wiring Diagram 2

Single Pole Wiring - Single-Circuit (MS-B102, MS-B102-V)

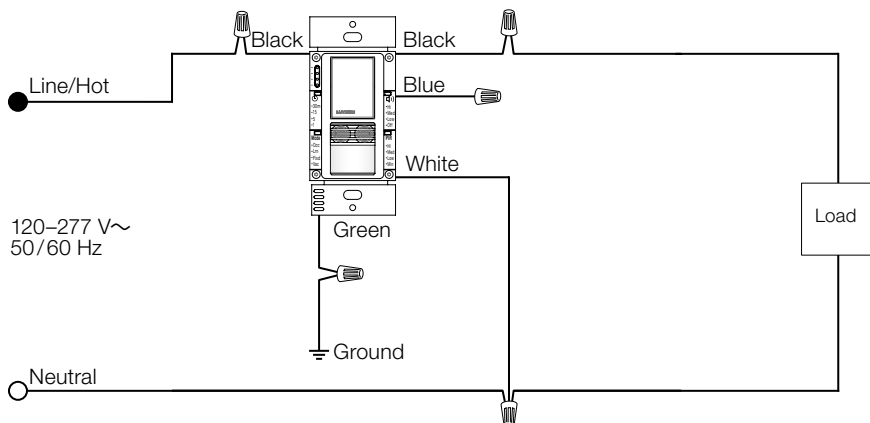

continued on next page...

Job Name:	Model Numbers:	
<input type="text"/>	<input type="text"/>	<input type="text"/>
Job Number:	<input type="text"/>	<input type="text"/>

Wiring Diagram 3

120 V~ Multi-Location Installation with Maestro® Accessory Switches (MS-B102, MSB102-V)

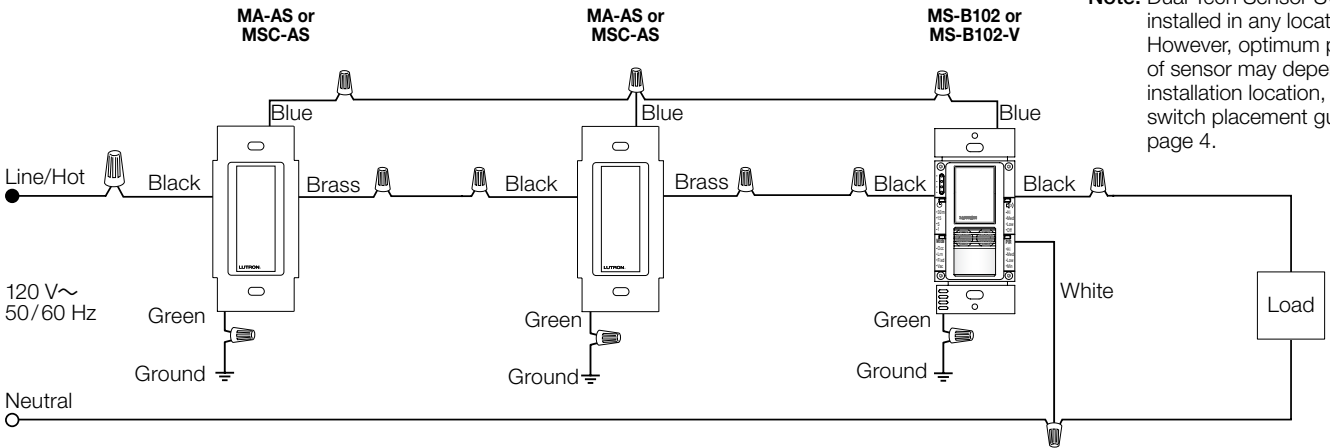

Note: Dual Tech Sensor Switch can be installed in any location. However, optimum performance of sensor may depend upon installation location, see sensor switch placement guidelines on page 4.

Wiring Diagram 4

220/240 V~ Multi-Location Installation with Maestro® Accessory Switches (MS-B102, MSB102-V)

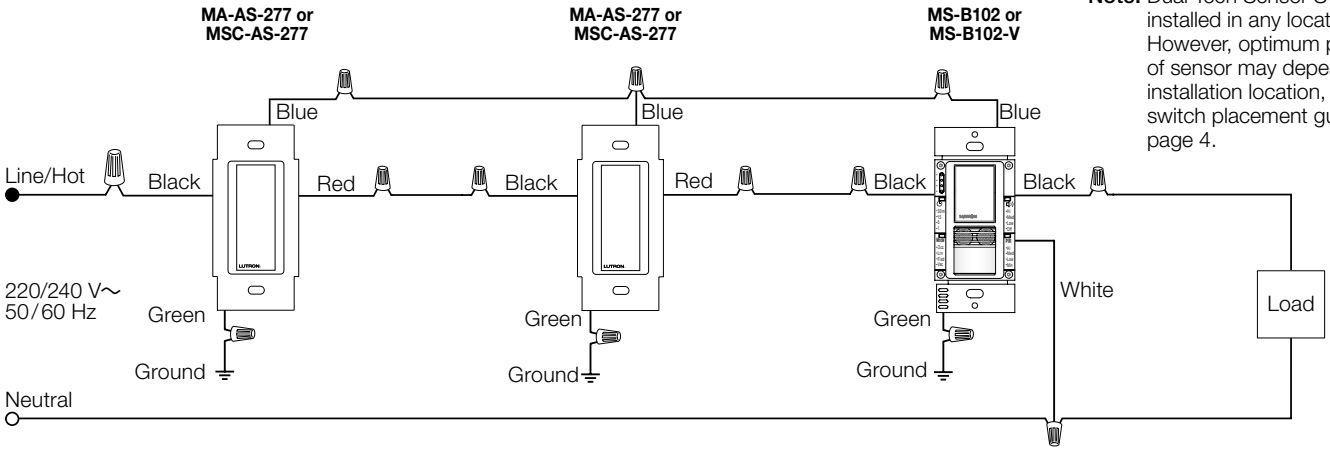

Note: Dual Tech Sensor Switch can be installed in any location. However, optimum performance of sensor may depend upon installation location, see sensor switch placement guidelines on page 4.

Wiring Diagram 5

277 V~ Multi-Location Installation with Maestro® Accessory Switches (MS-B102, MSB102-V)

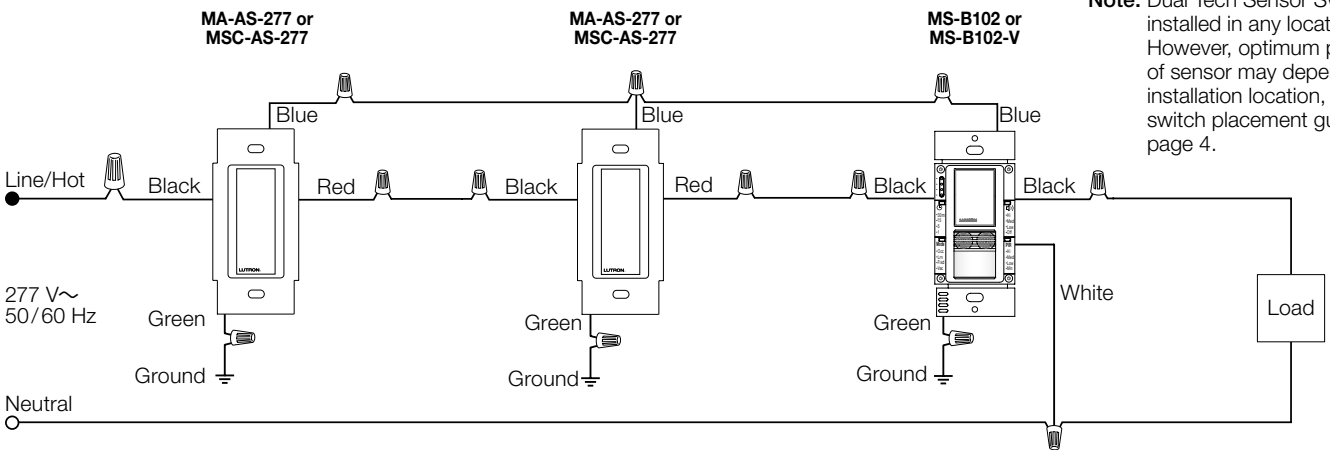

Note: Dual Tech Sensor Switch can be installed in any location. However, optimum performance of sensor may depend upon installation location, see sensor switch placement guidelines on page 4.

Job Name:	Model Numbers:	
<input type="text"/>	<input type="text"/>	<input type="text"/>
Job Number:	<input type="text"/>	<input type="text"/>

Wiring Diagrams - Single-Circuit (continued)

Wiring Diagram 6

3-Way Installation - Single-Circuit (MS-B102, MS-B102-V)

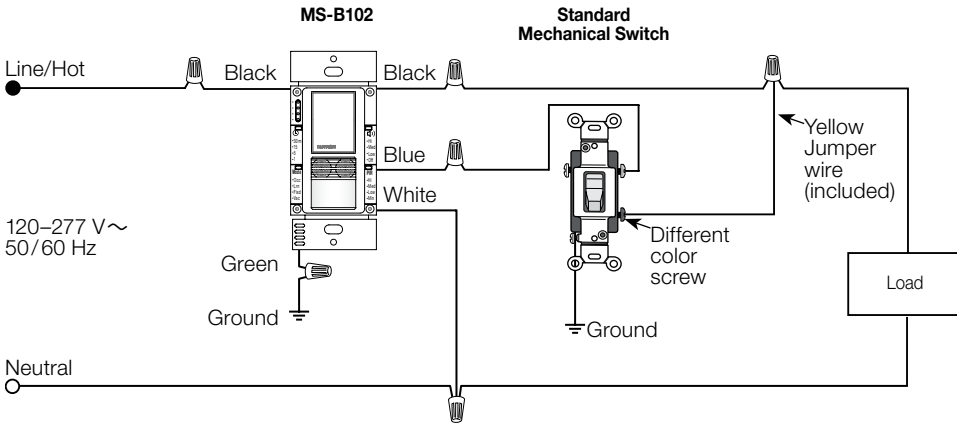

Note: Dual Tech Sensor Switch can be installed in any location. However, optimum performance of sensor may depend upon installation location, see sensor switch placement guidelines on page 4.

3-Way Installation

For retrofit 3-way installations the mechanical switch needs to be rewired as shown in the diagram below after wiring the Dual Tech Sensor Switch. Otherwise the 3-way installation will not work as expected. Single Pole mechanical switches may also be used in a 3-way installation with MS-B102, MS-B102-V and MS-B202 models.

1. Connect Ground: Ensure the bare copper or green ground wire from the wallbox is connected to the green ground screw of the mechanical switch.
2. Tag circuit Common: Your 3-way mechanical switch should have three screw terminals, two of the same color, and one of a different color. Tag the wire that is connected to the screw terminal of a different color.
3. Identify the wire that matches the color of the wire you connected to the blue wire of the Maestro® Dual Technology Occupancy Sensor Switch. Connect this wire to one of the two terminals of the same color.
4. Combine the tagged wire, the remaining wire and yellow jumper wire (included) using a wire connector. Connect the other end of jumper wire to the different color screw.

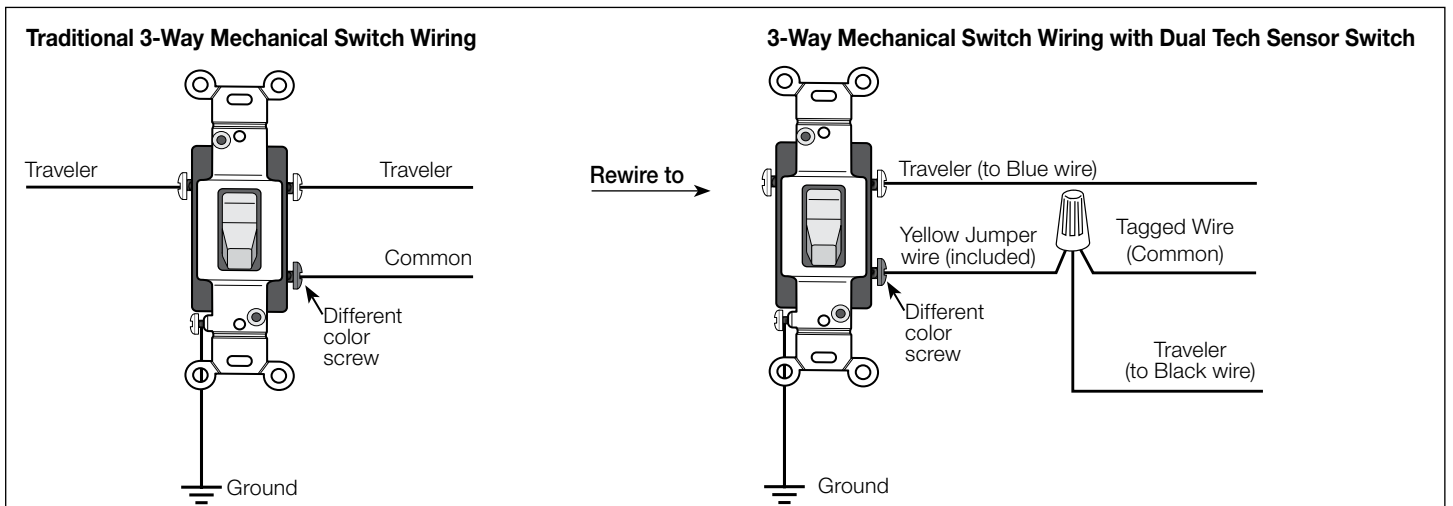

Job Name:	Model Numbers:	
<input type="text"/>	<input type="text"/>	<input type="text"/>
Job Number:	<input type="text"/>	<input type="text"/>

Wiring Diagrams - Dual-Circuit

Wiring Diagram 1

Single Pole, Single Breaker Feed Wiring - Dual-Circuit (MS-A202)

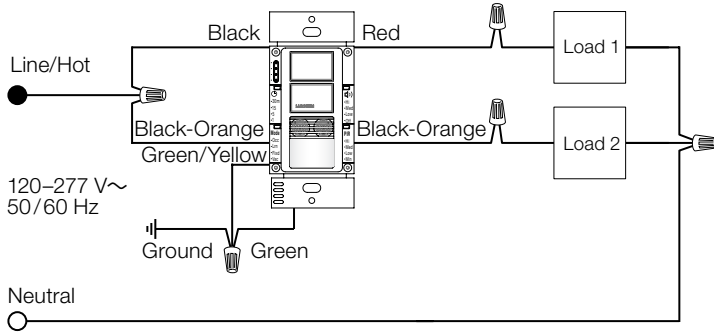

Wiring Diagram 2

Single Pole, Single Breaker Feed Wiring - Dual-Circuit (MS-B202)

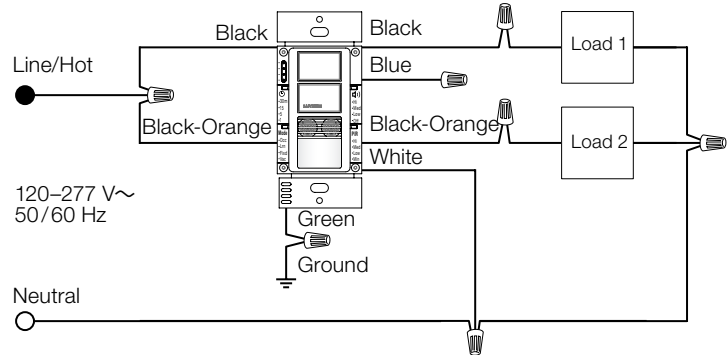

Wiring Diagram 3

Single Pole, Two Breaker Feed Wiring: Dual-Circuit (MS-A202)

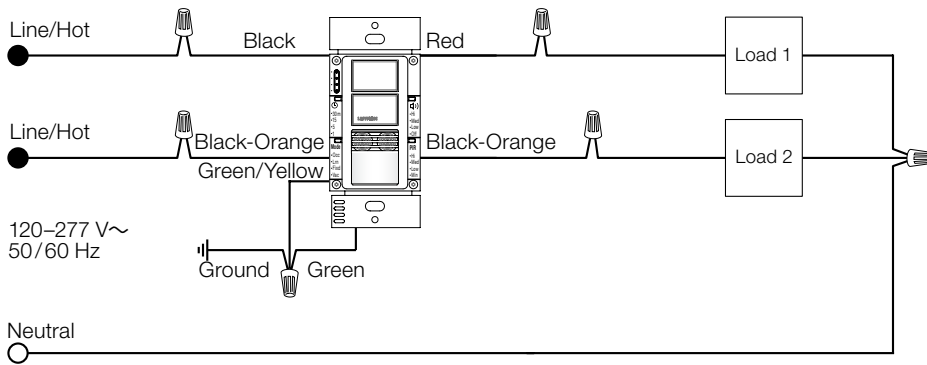

Wiring Diagram 4

Single Pole, Two Breaker Feed Wiring: Dual-Circuit (MS-B202)

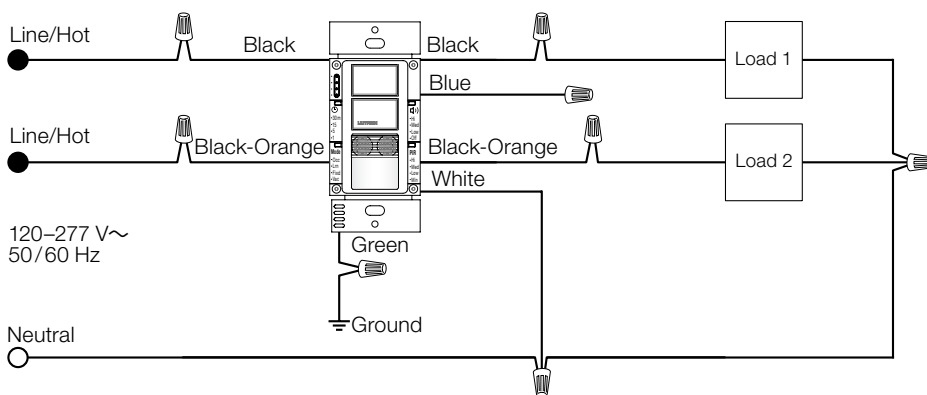

Wiring must comply with NEC® code for wiring multiple branch circuits. Where two or more branch circuits supply devices or equipment on the same yoke, a means to simultaneously disconnect the ungrounded conductors supplying those devices shall be provided at the point at which the branch circuits originate.

continued on next page...

Job Name:	Model Numbers:	
<input type="text"/>	<input type="text"/>	<input type="text"/>
Job Number:	<input type="text"/>	<input type="text"/>

Wiring Diagrams - Dual-Circuit (continued)

Wiring Diagram 5

3-Way Installation, Single Breaker Feed Wiring: Dual-Circuit (MS-B202)

NOTE: Do not use Maestro® accessory switches with MS-B202.

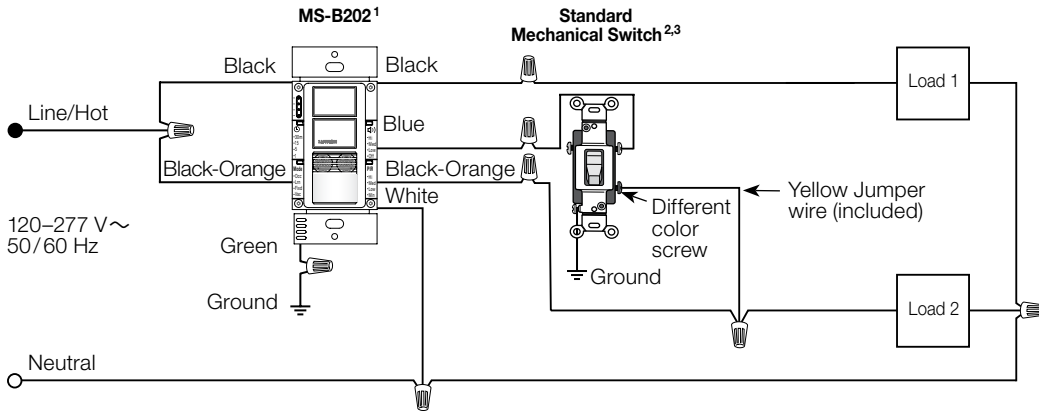

Wiring Diagram 6

3-Way Installation, Two Breaker Feed Wiring: Dual-Circuit (MS-B202)

Wiring must comply with NEC® code for wiring multiple branch circuits. Where two or more branch circuits supply devices or equipment on the same yoke, a means to simultaneously disconnect the ungrounded conductors supplying those devices shall be provided at the point at which the branch circuits originate.

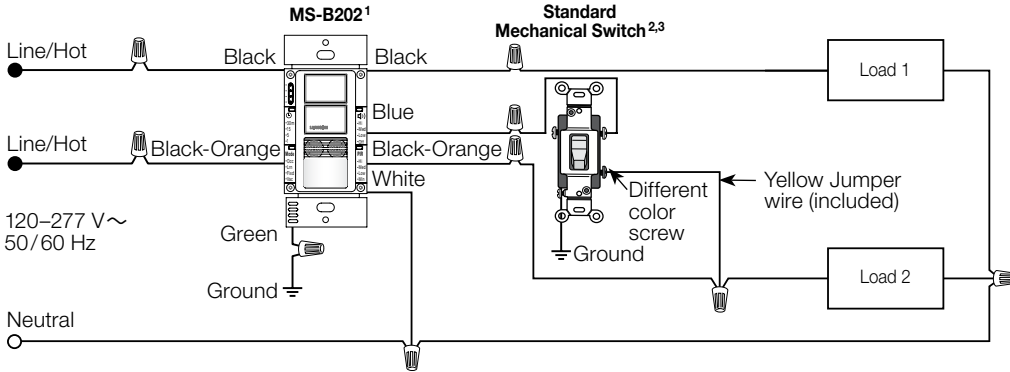

- ¹ Dual Tech Sensor Switch can be installed in any location.
- ² Mechanical switch may be wired to **either** circuit, and will control both. **Do NOT** wire mechanical switch to **both** circuits.
- ³ You may use no more than one mechanical switch with a dual-circuit Dual Tech Sensor Switch.

Job Name:	Model Numbers:	
<input type="text"/>	<input type="text"/>	<input type="text"/>
Job Number:	<input type="text"/>	<input type="text"/>

3-Way Installation

For retrofit 3-way installations the mechanical switch needs to be rewired as shown in the diagram below after wiring the Dual Tech Sensor Switch. Otherwise the 3-way installation will not work as expected. Single-Pole mechanical switches may also be used in a 3-way with MS-B102, MS-B102-V and MS-B202 models.

1. Connect Ground: Ensure the bare copper or green ground wire from the wallbox is connected to the green ground screw of the mechanical switch.
2. Tag circuit Common: Your 3-way mechanical switch should have three screw terminals, two of the same color, and one of a different color. Tag the wire that is connected to the screw terminal of a different color.
3. Identify the wire that matches the color of the wire you connected to the blue wire of the Maestro® Dual Technology Occupancy Sensor Switch. Connect this wire to one of the two terminals of the same color.
4. Combine the tagged wire, the remaining wire and yellow jumper wire (included) using a wire connector. Connect the other end of jumper wire to the different color screw.

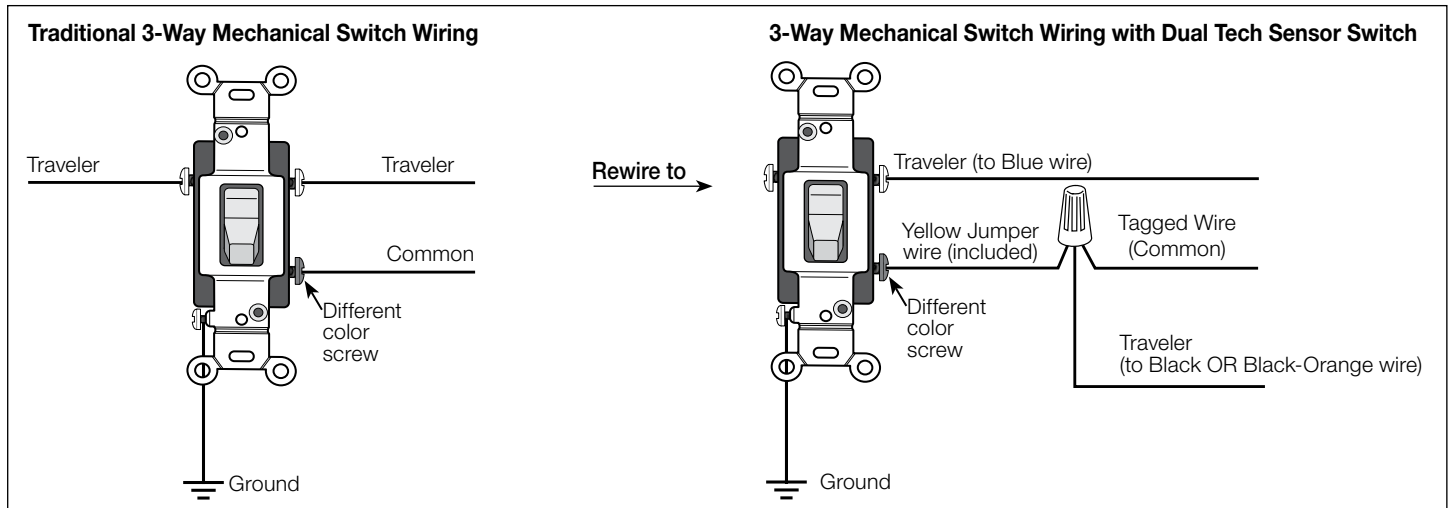

How Loads Operate in 3-Way with Dual-Circuit Sensor Switch (MS-B202)

	Initial Load State		After flipping 3-way mechanical switch	
	Circuit 1	Circuit 2	Circuit 1	Circuit 2
When All Lights are OFF	Off	Off	On	On
When All Lights are ON	On	On	Off	Off
When One Circuit is ON	On	Off	Off	Off
	Off	On	Off	Off

Job Name:	Model Numbers:	
<input type="text"/>	<input type="text"/>	<input type="text"/>
Job Number:	<input type="text"/>	<input type="text"/>

Colors and Finishes

Gloss Finishes

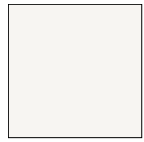

White
WH

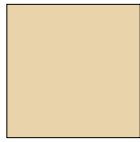

Ivory
IV

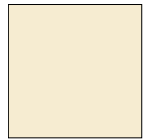

Almond
AL

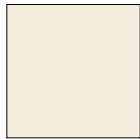

Light Almond
LA

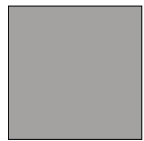

Gray
GR



Brown
BR



Black
BL

Satin Finishes



Hot
HT



Merlot
MR



Plum
PL



Turquoise
TQ



Taupe
TP



Eggshell
ES



Biscuit
BI



Snow
SW



Palladium
PD



Midnight
MN



Sienna
SI



Terracotta
TC

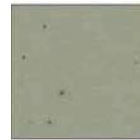

Greenbriar
GB



Bluestone
BG



Mocha Stone
MS



Goldstone
GS



Desert Stone
DS



Stone
ST



Limestone
LS



Sea Glass
SG

- Due to printing limitations, colors and finishes shown cannot be guaranteed to match actual product colors perfectly.
- Color chip keychains are available for more precise color matching:
Gloss Finishes: DG-CK-1
Satin Finishes: SC-CK-1

Job Name: <input type="text"/>	Model Numbers: <input type="text"/>	
Job Number: <input type="text"/>	<input type="text"/>	<input type="text"/>