

# MR16 Series

TrueWhite® LED Lamp

## Product Description

The Cree® MR16 Series TrueWhite® LED Lamp is a true 50W halogen MR16 equivalent that delivers up to 584 lumens of superior 90 CRI with high R9 color quality while achieving up to 67 lumens per watt. This MR16 boasts a slim design to allow universal form and fit into most global MR16 fixtures and is available in a variety of beam angles with a color temperature of 3000K. The Cree MR16 Series TrueWhite® LED Lamp's impressive combination of greater than 80% energy savings and significant maintenance savings make it a perfect solution for track and accent lighting.

## Performance Summary

**Delivered Light Output:** 540 lumens (15D), 580 lumens (25D), 584 lumens (40D)

**Input Power:** 8.7 watts (50W eq)

**CRI:** >90

**CCT:** 3000K

**Beam Angle:** 15°, 25° and 40°

**CBCP:** 4648 (15D), 2473 (25D), 1296 (40D)

**Limited Warranty:** 3 years

**Lifetime:** Designed to last 25,000 hours

**Dimming:** 5%\*

15°



25°



40°

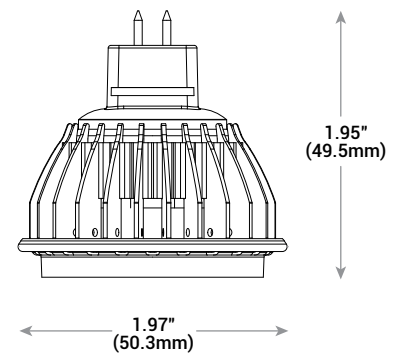

## Ordering Information

Example: MR16-50W-30K-25D

MR16	50W	30K		
Product	Watt Equivalent	CCT	Beam Angle	Base Type
MR16	50W 50 Watt	30K 3000K	15D 15° Spot 25D 25° Flood 40D 40° Wide Flood	Blank GU5.3 Base

\* See [www.cree.com/lighting/products/warranty](http://www.cree.com/lighting/products/warranty) for warranty terms

\* Reference [www.cree.com/lighting](http://www.cree.com/lighting) for recommended dimmers



## MR16 Series

### Product Specifications

#### CREE TRUEWHITE® TECHNOLOGY

A revolutionary way to generate high-quality white light, Cree TrueWhite® Technology is a patented approach that delivers an exclusive combination of 90+ CRI, beautiful light characteristics, and lifelong color consistency, all while maintaining high luminous efficacy – a true no compromise solution.

#### CONSTRUCTION & MATERIALS

- Durable die-cast aluminum housing with lens protects LEDs and optical system
- Fanless housing design and smart thermal circuit design with embedded intelligent software properly monitors the operating temperature range
- Slim housing design meets ANSI form factor for halogen lamps

#### OPTICAL SYSTEM

- Single LED source
- Proprietary in-house designed lens is available in three beam angles of 15° Spot, 25° Flood and 40° Wide Flood
- Lens effectively eliminates surface glare and adds a pleasant touch of soft backlight

#### ELECTRICAL SYSTEM

- Power Factor > 0.9 nominal
- Input Voltage: 12Vac
- Dimming: 5%; see dimmer/transformer compatibility sheet

#### REGULATORY & VOLUNTARY QUALIFICATIONS

- CE Listed
- cULus Listed

15°

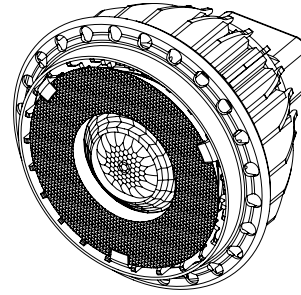

25°

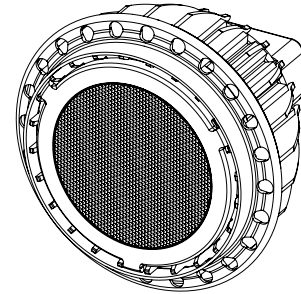

40°

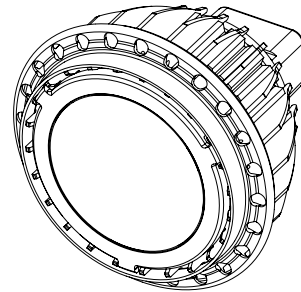

# MR16 Series

## Photometry

MR16-50W-30K-15D  
 BASED ON CESTL REPORT #: PL03761-001

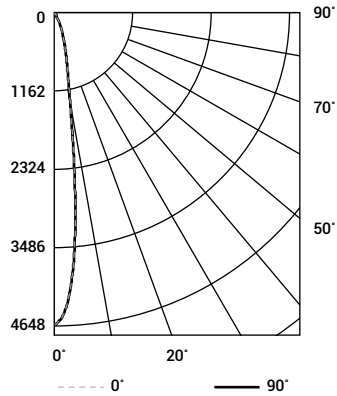

Reference [www.cree.com/lighting](http://www.cree.com/lighting) for detailed photometric data

Zonal Lumen Summary			
Zone	Lumens	% Lamp	Luminaire
0-30	489	N/A	90.6%
0-40	500	N/A	92.6%
0-60	517	N/A	95.8%
0-90	528	N/A	97.9%

Average Luminance Table (cd/m <sup>2</sup> )				
		Horizontal Angle		
		0°	45°	90°
Vertical Angle	45°	18154	18154	18154
	55°	28725	28725	28725
	65°	12316	12316	12316
	75°	16452	16452	16452
	85°	43781	43781	43781

Coefficients Of Utilization - Zonal Cavity Method				
RC %:	80			
RW %:	70	50	30	10
RCR: 0	118	118	118	118
1	114	112	110	108
2	110	106	103	101
3	107	102	98	95
4	103	98	94	91
5	100	95	90	87
6	98	92	87	84
7	95	89	85	82
8	93	86	82	80
9	91	84	80	78
10	89	82	78	76

Effective Floor Cavity Reflectance: 20%

### Illuminance at a Distance

	Center Beam fc	Beam Width
2.0 ft	1,162.1 fc	0.5 ft
4.0 ft	290.5 fc	1.0 ft
6.0 ft	129.1 fc	1.5 ft
8.0 ft	72.6 fc	2.0 ft
10.0 ft	46.5 fc	2.5 ft

MR16-50W-30K-25D  
 BASED ON CESTL REPORT #: PL03762-001

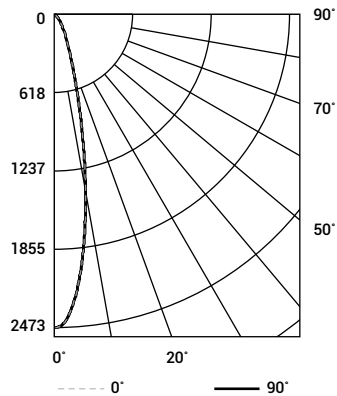

Reference [www.cree.com/lighting](http://www.cree.com/lighting) for detailed photometric data

Zonal Lumen Summary			
Zone	Lumens	% Lamp	Luminaire
0-30	474	N/A	81.9%
0-40	521	N/A	90.0%
0-60	548	N/A	94.6%
0-90	563	N/A	97.2%

Average Luminance Table (cd/m <sup>2</sup> )				
		Horizontal Angle		
		0°	45°	90°
Vertical Angle	45°	42484	42484	42484
	55°	22248	22248	22248
	65°	20087	20087	20087
	75°	25975	25975	25975
	85°	56085	56085	56087

Coefficients Of Utilization - Zonal Cavity Method				
RC %:	80			
RW %:	70	50	30	10
RCR: 0	118	118	118	118
1	113	111	108	106
2	109	104	101	98
3	104	99	94	91
4	100	94	89	86
5	97	90	85	81
6	93	86	81	77
7	90	82	78	74
8	87	79	75	71
9	84	77	72	69
10	82	74	69	66

Effective Floor Cavity Reflectance: 20%



# MR16 Series

## Photometry

MR16-50W-30K-40D

BASED ON CESTL REPORT #: PL03820-001

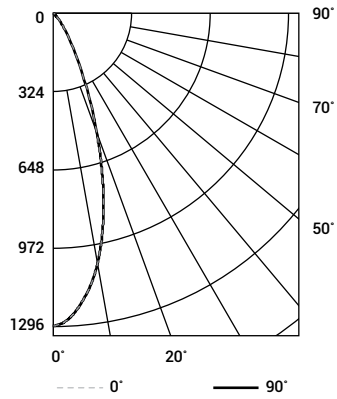

Reference [www.cree.com/lighting](http://www.cree.com/lighting) for detailed photometric data

Zonal Lumen Summary			
Zone	Lumens	% Lamp	Luminaire
0-30	469	N/A	80.8%
0-40	523	N/A	90.1%
0-60	548	N/A	94.4%
0-90	563	N/A	97.0%

Average Luminance Table (cd/m <sup>2</sup> )				
		Horizontal Angle		
		0°	45°	90°
Vertical Angle	45°	33521	33521	33521
	55°	21411	21411	21411
	65°	21137	21137	21137
	75°	22017	22017	22017
	85°	44071	44071	44071

Coefficients Of Utilization - Zonal Cavity Method				
RC %:	80			
RW %:	70	50	30	10
RCR: 0	118	118	118	118
1	113	110	108	106
2	108	103	99	96
3	103	97	93	89
4	99	92	87	83
5	95	87	82	78
6	91	83	77	73
7	87	79	73	70
8	84	75	70	66
9	81	72	67	63
10	78	69	64	61

Effective Floor Cavity Reflectance: 20%