



# PAR30S 12.5W

<b>OUTPUT RANGE: VIVID SERIES</b>	575 - 650 lumen
<b>OUTPUT RANGE: BRILLIANT SERIES</b>	735 - 795 lumen
<b>BEAM ANGLE RANGE</b>	8°, 25°, 36°, 50°
<b>COLOR TEMPERATURE RANGE</b>	2700K, 3000K, 4000K, 5000K
<b>APPLICATION</b>	Halogen replacement for indoor & outdoor applications



## POINT SOURCE OPTICS

Exceptional beam control enables unique 8° narrow spot and smooth uniform beams

Single light source, single crisp shadow

## VP<sub>3</sub> VIVID COLOR & VP<sub>3</sub> NATURAL WHITE

VIVID series provides accurate color rendering across the visible spectrum from 400nm to 700nm, with CRI/95\*, R9/95\*, Rf/90, Rg/100

Whiteness rendering matches or exceeds that of halogen and incandescent sources at 2700K and 3000K

## ENERGY EFFICIENCY & LONG LIFE

85% more energy efficient than standard halogen lamps

Typical payback of one year or less

Rated lifetime of 35,000 hours. 3 year warranty

## CERTIFICATIONS

RoHS, CE, UL/CUL, FCC Title 47 Part 15B



## HIGHLY COMPATIBLE

Narrow spot compatible with Soraa SNAP System accessories

Thermally and geometrically compatible with standard fixtures and suitable for damp locations

Suitable for fully enclosed fixtures. Can be used with front glass cover

Works with trailing edge and leading edge phase cut dimmers (see [www.soraa.com/resources](http://www.soraa.com/resources))

## INTENDED USE AND APPLICATIONS

Intended for use in PAR30S compatible recessed downlights, track lighting and other indoor and outdoor applications

Soraa lamps are designed to safely turn down in any thermal environment not conducive to minimum airflow or proper ventilation

## GENERAL SPECIFICATIONS

Form Factor	Operating Temperature	Electrical	Dimming and Flicker
Width: 96mm (3.78")	Minimum: -40°C (ambient)	Wattage: 12.5W	Dimmable to <20%
Height: 82mm (3.23")	Typical: 60°C - 70°C (base)	Power factor: 0.95	Flicker Index: <0.12
Weight: 269g	Maximum: 80°C (base)	Voltage: 120V +/- 12V	Percent Flicker: 32%
		Frequency: 50/60Hz	

\*Metrics apply to 2700K, 3000K, 4000K. 5000K color metrics are CRI/90, R9/95

## DIMENSIONS

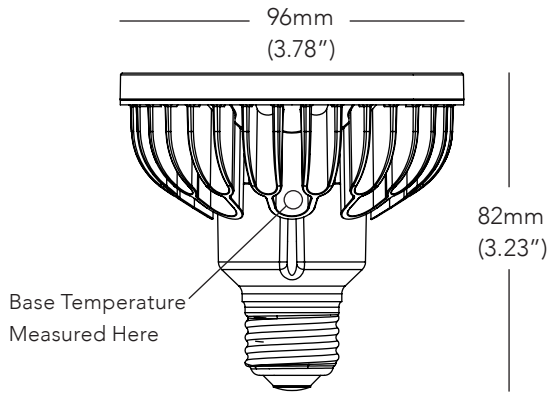

## COLOR RENDERING

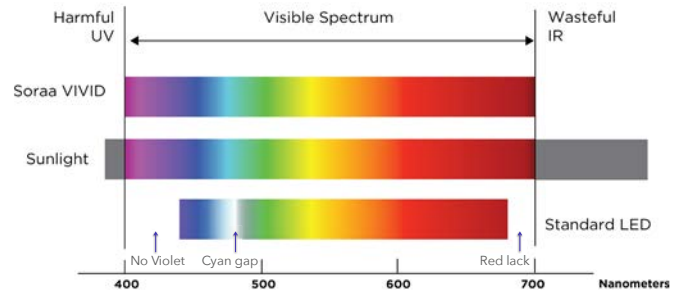

### 8 DEGREE BEAM

Beam Dia at 50% CBCP (ft)	Field Dia at 10% CBCP (ft)	Foot-candles (% of CBCP)
0.2	0.7	6.8%
0.4	1.5	2.3%
0.6	2.2	1.1%
0.8	2.9	0.7%
1.0	3.7	0.4%

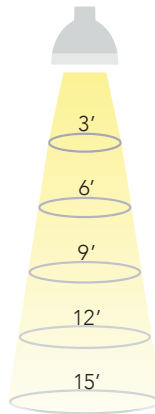

### 25 DEGREE BEAM

Beam Dia at 50% CBCP (ft)	Field Dia at 10% CBCP (ft)	Foot-candles (% of CBCP)
1.3	2.2	6.8%
2.7	4.4	2.3%
4.0	6.6	1.1%
5.3	8.7	0.7%
6.7	10.9	0.4%

### 50 DEGREE BEAM

Beam Dia at 50% CBCP (ft)	Field Dia at 10% CBCP (ft)	Foot-candles (% of CBCP)
2.8	5.0	6.8%
5.6	10.1	2.3%
8.4	15.1	1.1%
11.2	20.1	0.7%
14.0	25.2	0.4%

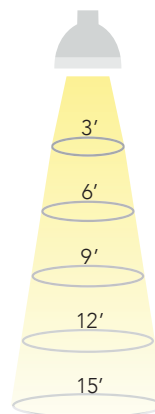

### 36 DEGREE BEAM

Beam Dia at 50% CBCP (ft)	Field Dia at 10% CBCP (ft)	Foot-candles (% of CBCP)
1.9	3.5	6.8%
3.9	6.9	2.3%
5.8	10.4	1.1%
7.8	13.9	0.7%
9.7	17.3	0.4%

Note: Footcandles may be calculated by multiplying the CBCP of the desired model number by the percentage in the tables above

## SPECIFICATIONS BY MODEL NUMBER\* SORAA LED PAR30S 12.5W

Model #	Product Code	CCT (K)	Beam Angle	Field Angle	CBCP (Cd)	Halogen Equivalent	Total Flux (Lm)	Efficacy (Lm/W)	McA	Energy Star	SNAP
<b>VIVID SERIES</b>											
SP30S-12-08D-927-03	01523	2700	8	14	15520	90	575	46	3	-	YES
SP30S-12-25D-927-03	01525	2700	25	40	3100	75	575	46	3	-	-
SP30S-12-36D-927-03	01527	2700	36	60	1420	75	575	46	3	-	-
SP30S-12-50D-927-03	01529	2700	50	80	740	75	575	46	3	-	-
SP30S-12-08D-930-03	01539	3000	8	14	16740	90	620	50	3	-	YES
SP30S-12-25D-930-03	01541	3000	25	40	3340	75	620	50	3	-	-
SP30S-12-36D-930-03	01543	3000	36	60	1540	75	620	50	3	-	-
SP30S-12-50D-930-03	01545	3000	50	80	800	75	620	50	3	-	-
SP30S-12-08D-940-03	01555	4000	8	14	17400	90	645	52	4	-	YES
SP30S-12-25D-940-03	01557	4000	25	40	3480	75	645	52	4	-	-
SP30S-12-36D-940-03	01559	4000	36	60	1600	75	645	52	4	-	-
SP30S-12-50D-940-03	01561	4000	50	80	820	75	645	52	4	-	-
SP30S-12-08D-950-03	01563	5000	8	14	17540	90	650	52	5	-	YES
SP30S-12-25D-950-03	01565	5000	25	40	3500	75	650	52	5	-	-
SP30S-12-36D-950-03	01567	5000	36	60	1620	75	650	52	5	-	-
SP30S-12-50D-950-03	01569	5000	50	80	840	75	650	52	5	-	-
<b>BRILLIANT SERIES</b>											
SP30S-12-08D-827-03	01531	2700	8	14	19840	100	735	59	3	-	YES
SP30S-12-25D-827-03	01533	2700	25	40	3960	90	735	59	3	-	-
SP30S-12-36D-827-03	01535	2700	36	60	1820	90	735	59	3	-	-
SP30S-12-50D-827-03	01537	2700	50	80	940	90	735	59	3	-	-
SP30S-12-08D-830-03	01547	3000	8	14	21460	100	795	64	3	-	YES
SP30S-12-25D-830-03	01549	3000	25	40	4280	90	795	64	3	-	-
SP30S-12-36D-830-03	01551	3000	36	60	1980	90	795	64	3	-	-
SP30S-12-50D-830-03	01553	3000	50	80	1020	90	795	64	3	-	-

**CCT:** Correlated Color Temperature **McA:** White Point Accuracy in McA step **SNAP:** SORAA SNAP System Compatible

\*Specifications are at stable warm operating conditions (25°C ambient)

**SERIES/CCT**

**COLOR ACCURACY**

**WHITENESS INDEX**

**SPECTRAL POWER DISTRIBUTION**

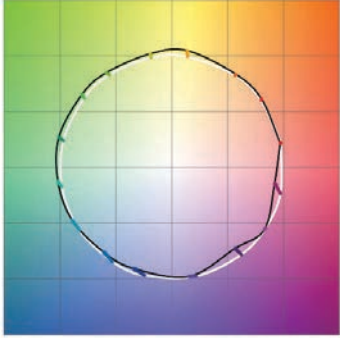
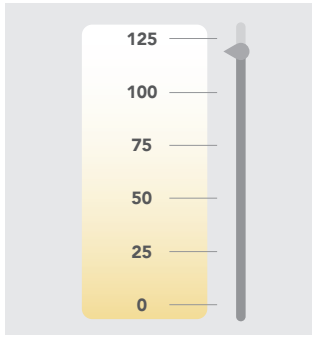
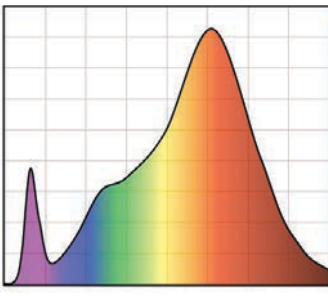
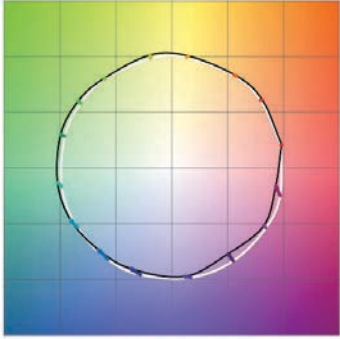
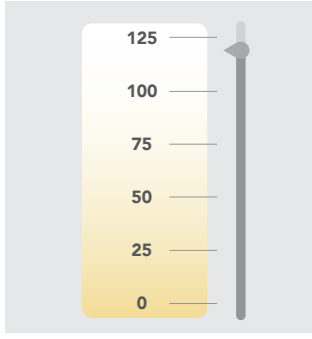
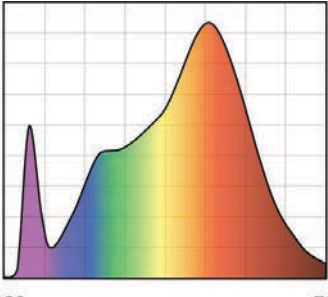
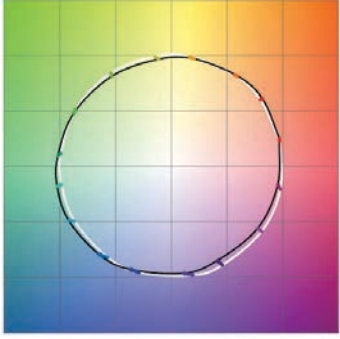
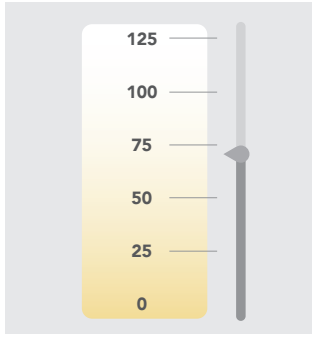
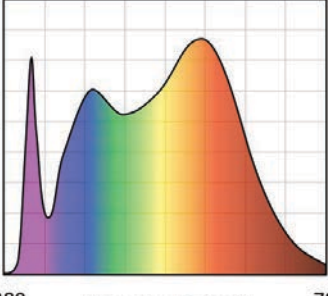
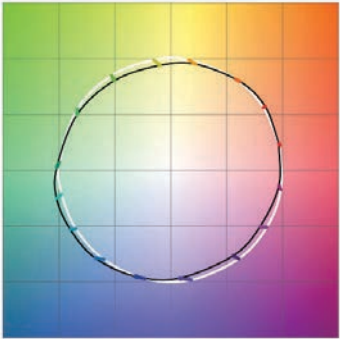
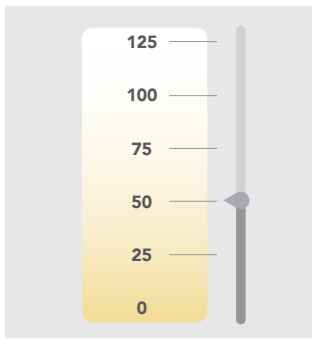
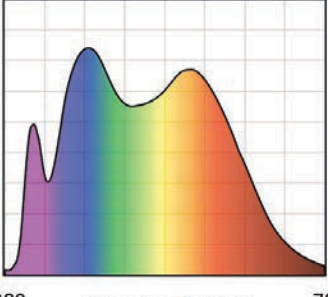
<p><b>VIVID 2700K</b></p>	 <p>Rf: 90, Rg: 100, Rfh1: 95</p>	 <p>Rw: 120</p>	 <p>380 Wavelength (nm) 780</p> <p>CRI: 95, R9: 95</p>
<p><b>VIVID 3000K</b></p>	 <p>Rf: 90, Rg: 100, Rfh1: 95</p>	 <p>Rw: 120</p>	 <p>380 Wavelength (nm) 780</p> <p>CRI: 95, R9: 95</p>
<p><b>VIVID 4000K</b></p>	 <p>Rf: 90, Rg: 100, Rfh1: 95</p>	 <p>Rw: 70</p>	 <p>380 Wavelength (nm) 780</p> <p>CRI: 95, R9: 95</p>
<p><b>VIVID 5000K</b></p>	 <p>Rf: 90, Rg: 100, Rfh1: 95</p>	 <p>Rw: 50</p>	 <p>380 Wavelength (nm) 780</p> <p>CRI: 90, R9: 95</p>

**SERIES/CCT**

**COLOR ACCURACY**

**WHITENESS INDEX**

**SPECTRAL POWER DISTRIBUTION**

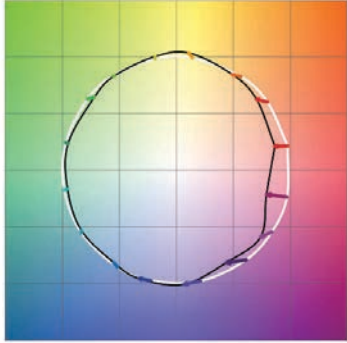
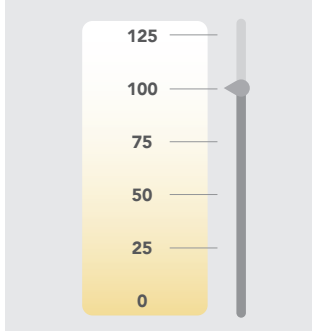
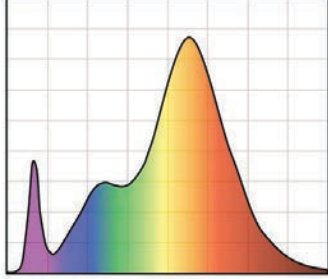
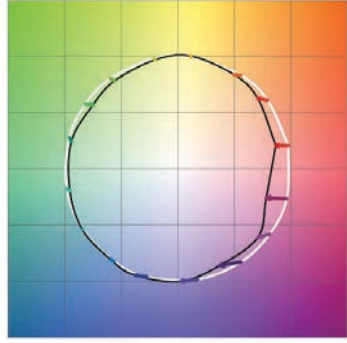
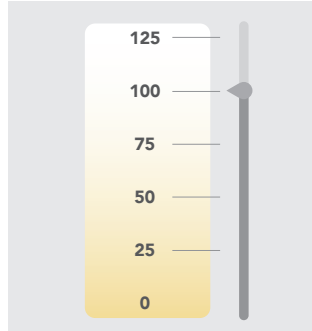
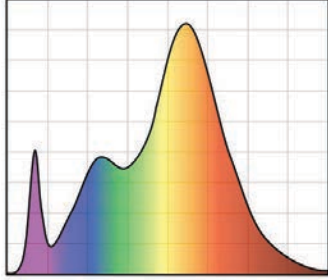
<p><b>BRILLIANT 2700K</b></p>	 <p><b>Rf: 85, Rg: 92, Rfh1: 77</b></p>	 <p><b>Rw: 100</b></p>	 <p><b>Wavelength (nm)</b> 380 780</p> <p><b>CRI: 85, R9: &gt;0</b></p>
<p><b>BRILLIANT 3000K</b></p>	 <p><b>Rf: 85, Rg: 92, Rfh1: 77</b></p>	 <p><b>Rw: 100</b></p>	 <p><b>Wavelength (nm)</b> 380 780</p> <p><b>CRI: 85, R9: &gt;0</b></p>

Rf: TM-30 metric measuring color fidelity (whether colors are similar to those under natural light). Rf is a more accurate version of the CRI Ra. Rf is 100 for natural light.  
 Rg: TM-30 metric measuring color gamut (whether colors are more saturated than under natural light). Rg is 100 for natural light.  
 Rfh1: TM-30 metric measuring color fidelity for red tones. Rfh1 is a more accurate version of the CRI R9. Rfh1 is 100 for natural light.  
 Rw: Soraa-developed metric to measure white fidelity. Rw measures the magnitude of excitation of whitening agents within whites. Rw is about 100 for natural light.