



# Perfect sparkle, easy application

MASTERColour CDM-Rm Elite Mini

Mini, very high-efficiency Ceramic Metal Halide discharge reflector lamp producing crisp white sparkling light with high color rendering

## Benefits

- High-intensity beam of crisp white sparkling light makes merchandise look irresistible
- Easy to install and replace, reducing installation and relamping costs
- Fits in small luminaires which are less visible

## Features

- Crisp white sparkling light
- Excellent color rendering, with extra red
- High efficacy with unparalleled lumen maintenance
- Mini design fitting in open luminaires
- UV-blocking front glass

## Application

- Accent and display lighting in retail
- General and decorative indoor lighting

## Warnings and Safety

- Use only with electronic control gear
- Control gear must include end-of-life protection (IEC61167, IEC 62035).
- A lamp breaking is extremely unlikely to have any impact on your health. If a lamp breaks, ventilate the room for 30 minutes and remove the parts, preferably with gloves. Put them in a sealed plastic bag and take it to your local waste facilities for recycling. Do not use a vacuum cleaner.

**PHILIPS**

Related products



CDM-Rm, 35W/50W, /930, GX10, MR16, 25D/40D



CDM-Rm, 35W, GX10, MR16, 10D



CDM-Rm, 50W, /930, 60D

Dimensional drawing

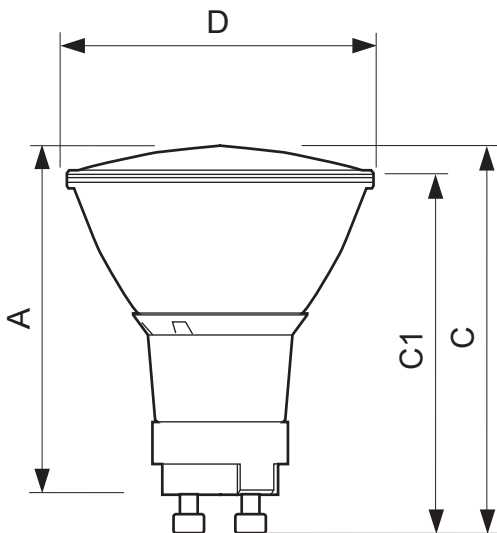

MASTERColour CDM-Rm Elite Mini 50W/930 GX10 MR16 60D

Product	A (Max)	C (Norm)	C (Max)	C1 (Max)	D (Norm)	D (Max)
CDM-Rm 50W/930 GX10 MR16 60D	59	62.75	65.4	60.9	50	51
CDM-Rm 50W/930 GX10 MR16 25D	59	62.75	65.4	60.9	50	51
CDM-Rm 50W/930 GX10 MR16 40D	59	62.75	65.4	60.9	50	51
CDM-Rm 35W/930 GX10 MR16 10D	59	62.75	65.4	60.9	50	51
CDM-Rm 35W/930 GX10 MR16 25D	59	62.75	65.4	60.9	50	51
CDM-Rm 35W/930 GX10 MR16 40D	59	62.75	65.4	60.9	50	51

General Characteristics

Order code	Full product name	Cap-Base	Bulb	Bulb Finish	Operating Position	Life to 5% failures	Life to 10% failures	Life to 20% failures	Life to 50% failures
928193205330	MASTERColour CDM-Rm Elite Mini 50W/930 GX10 MR16 25D	GX10	MR16	-	any	6000 hr	7500 hr	9000 hr	12000 hr
928193305330	MASTERColour CDM-Rm Elite Mini 50W/930 GX10 MR16 40D	GX10	MR16	-	any	6000 hr	7500 hr	9000 hr	12000 hr
928194705330	MASTERColour CDM-Rm Elite Mini 35W/930 GX10 MR16 25D	GX10	MR16	-	any	9000 hr	10000 hr	12000 hr	15000 hr
928194805330	MASTERColour CDM-Rm Elite Mini 35W/930 GX10 MR16 40D	GX10	MR16	-	any	9000 hr	10000 hr	12000 hr	15000 hr
928194605330	MASTERColour CDM-Rm Elite Mini 35W/930 GX10 MR16 10D	GX10	MR16	-	any	9000 hr	10000 hr	12000 hr	15000 hr
928193105330	MASTERColour CDM-Rm Elite Mini 50W/930 GX10 MR16 60D	GX10	MR16	-	any	6000 hr	7500 hr	9000 hr	12000 hr

Installation diagrams

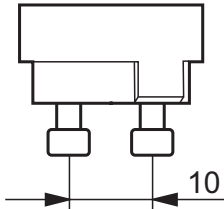
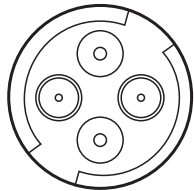

GX10

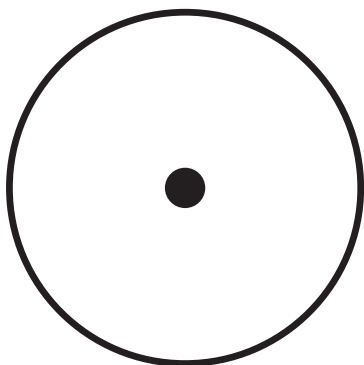

any

Light Technical Characteristics (1/2)

Order code	Full product name	Beam Description	Beam Angle	Luminous Intensity	Color Code	Color Rendering Index	Color Temperature	Luminous Flux Lamp EM	Luminous Flux Lamp EL	Forward Luminous Output	Forward Luminous Efficacy
928193205330	MASTERColour CDM-Rm Elite Mini 50W/930 GX10 MR16 25D	-	25 D	11500 cd	930	87 (min), 90 (nom) Ra8	3000 K	Lm	Lm	3150 (min), 3500 (nom) Lm	70 Lm/W
928193305330	MASTERColour CDM-Rm Elite Mini 50W/930 GX10 MR16 40D	-	40 D	7000 cd	930	87 (min), 90 (nom) Ra8	3000 K	Lm	Lm	3150 (min), 3500 (nom) Lm	70 Lm/W
928194705330	MASTERColour CDM-Rm Elite Mini 35W/930 GX10 MR16 25D	-	25 D	8500 cd	930	90 (min), 91 (nom) Ra8	3000 K	Lm	Lm	2200 (min), 2400 (nom) Lm	61.5 Lm/W
928194805330	MASTERColour CDM-Rm Elite Mini 35W/930 GX10 MR16 40D	-	40 D	4400 cd	930	90 (min), 91 (nom) Ra8	3000 K	Lm	Lm	2200 (min), 2400 (nom) Lm	61.5 Lm/W
928194605330	MASTERColour CDM-Rm Elite Mini 35W/930 GX10 MR16 10D	-	10 D	20000 cd	930	90 (min), 91 (nom) Ra8	3000 K	Lm	Lm	2200 (min), 2400 (nom) Lm	61.5 Lm/W
928193105330	MASTERColour CDM-Rm Elite Mini 50W/930 GX10 MR16 60D	-	60 D	3000 cd	930	87 (min), 90 (nom) Ra8	3000 K	Lm	Lm	3150 (min), 3500 (nom) Lm	70 Lm/W

Light Technical Characteristics (2/2)

Order code	Full product name	LLMF - end nominal lifetime	Forward Lum Maintenance 2000h	Forward Lum Maintenance 4000h	Forward Lum Maintenance 8000h	Forward Lum Maintenance 12000h	Forward Lum Maintenance 15000h	Design Mean Lumens EL	Chromaticity Coordinate X	Chromaticity Coordinate Y
928193205330	MASTERColour CDM-Rm Elite Mini 50W/930 GX10 MR16 25D	87 %	95 %	93 %	90 %	87 %	%	3200 Lm	0.441 -	0.406 -
928193305330	MASTERColour CDM-Rm Elite Mini 50W/930 GX10 MR16 40D	87 %	95 %	93 %	90 %	87 %	%	3200 Lm	0.441 -	0.406 -
928194705330	MASTERColour CDM-Rm Elite Mini 35W/930 GX10 MR16 25D	86 %	95 %	93 %	90 %	87 %	86 %	2200 Lm	0.439 -	0.403 -
928194805330	MASTERColour CDM-Rm Elite Mini 35W/930 GX10 MR16 40D	86 %	95 %	93 %	90 %	87 %	86 %	2200 Lm	0.439 -	0.403 -
928194605330	MASTERColour CDM-Rm Elite Mini 35W/930 GX10 MR16 10D	86 %	95 %	93 %	90 %	87 %	86 %	2200 Lm	0.439 -	0.403 -
928193105330	MASTERColour CDM-Rm Elite Mini 50W/930 GX10 MR16 60D	87 %	95 %	93 %	90 %	87 %	%	3200 Lm	0.441 -	0.406 -

Light technical

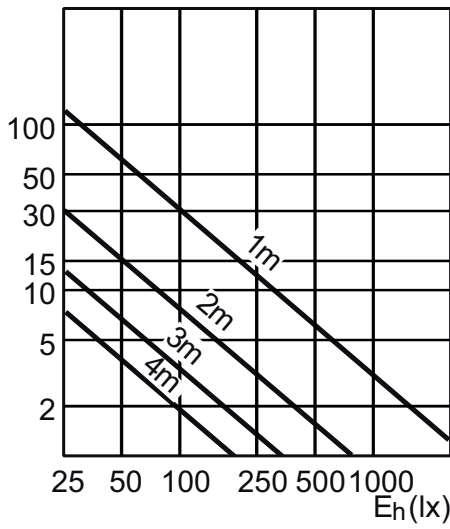

CDM-Rm 50W /930 60D

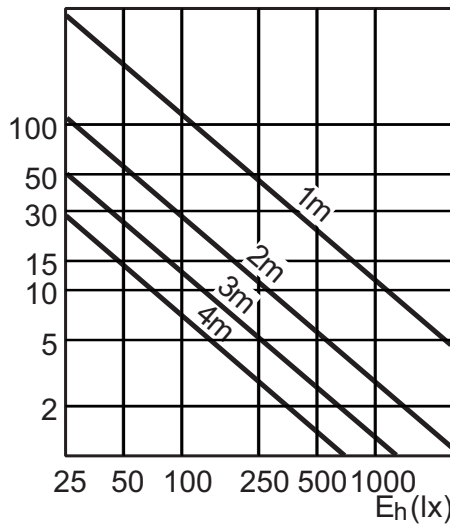

CDM-Rm 50W /930 25D

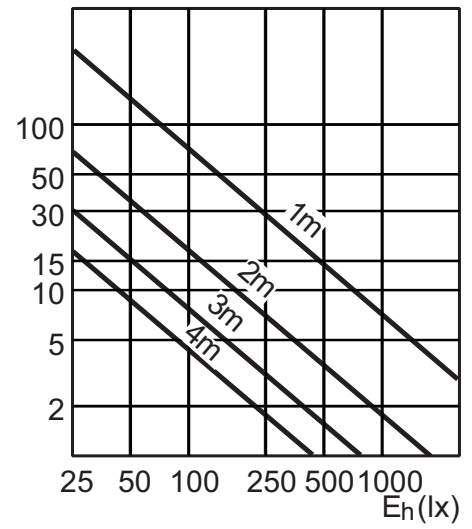

CDM-Rm 50W /930 40D

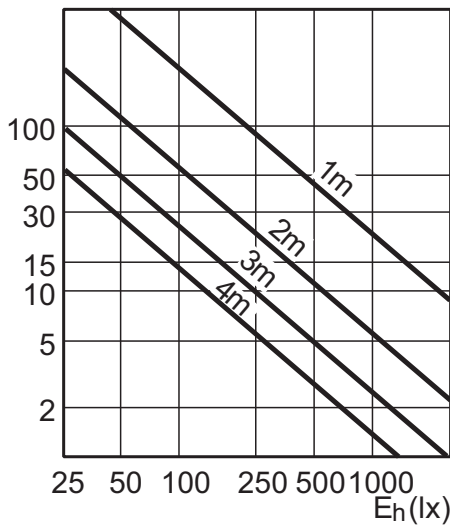

CDM-Rm 35W /930 10D

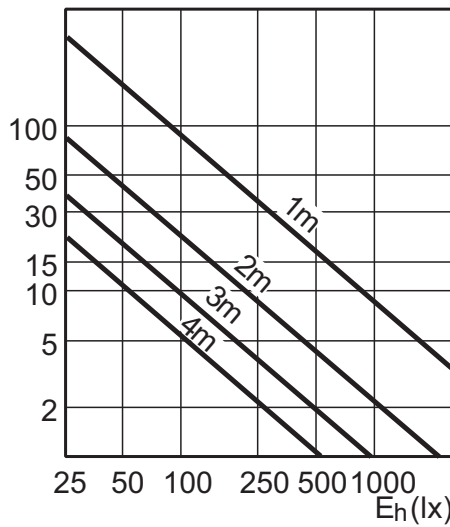

CDM-Rm 35W /930 25D

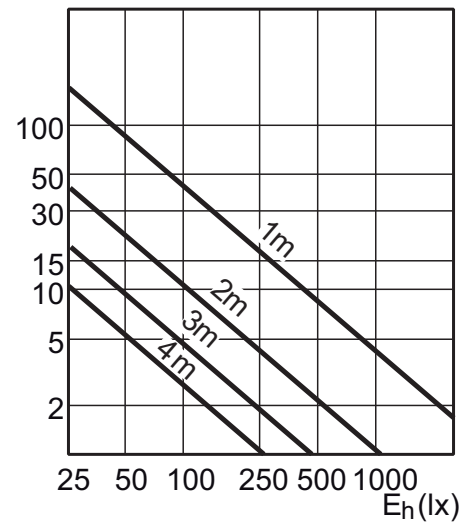

CDM-Rm 35W /930 40D

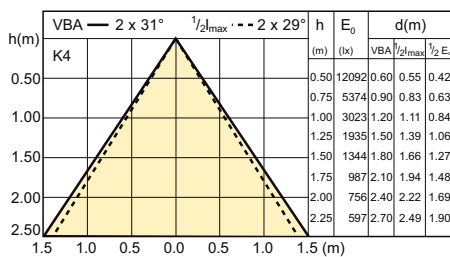

CDM-Rm 50W /930 60D

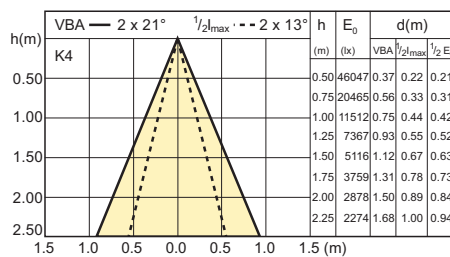

CDM-Rm 50W /930 25D

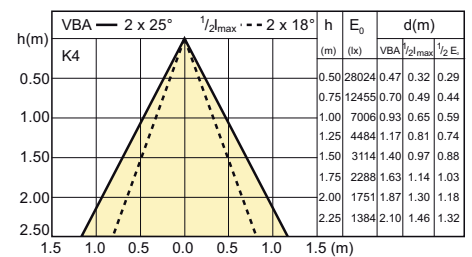

CDM-Rm 50W /930 40D

Light technical

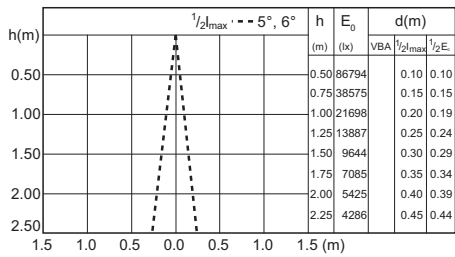

CDM-Rm 35W /930 10D

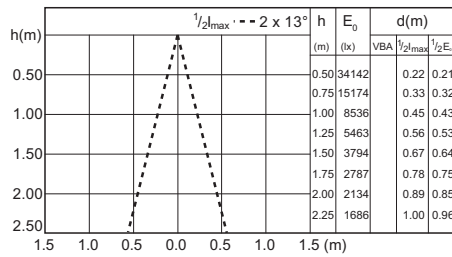

CDM-Rm 35W /930 25D

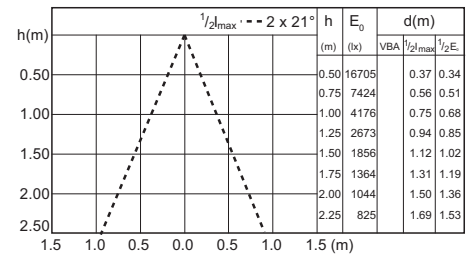

CDM-Rm 35W /930 40D

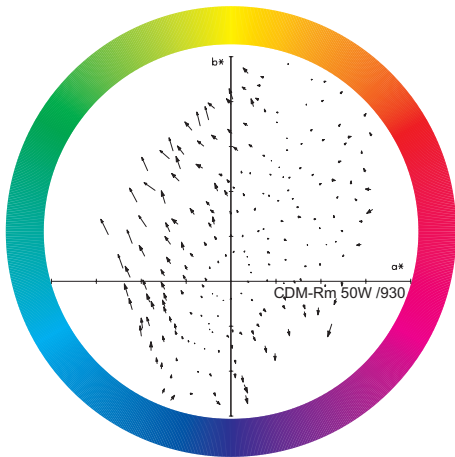

CDM-Rm 50W /930

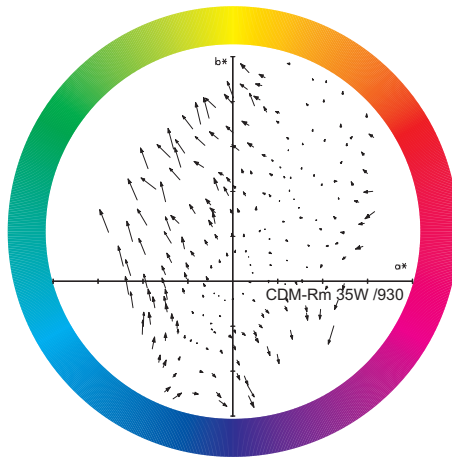

CDM-Rm 35W /930

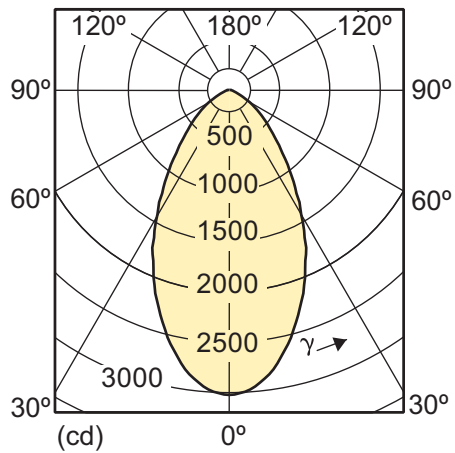

CDM-Rm 50W /930 60D

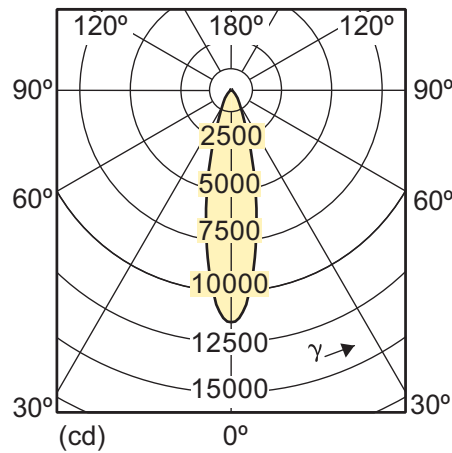

CDM-Rm 50W /930 25D

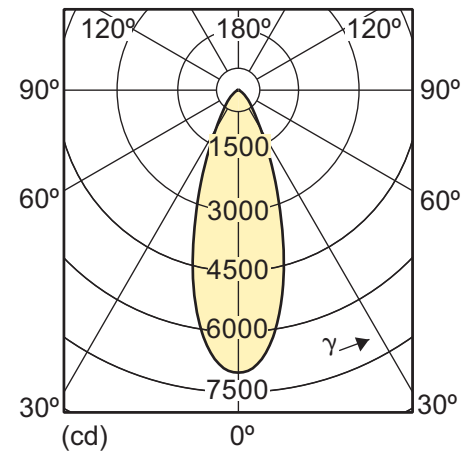

CDM-Rm 50W /930 40D

Light technical

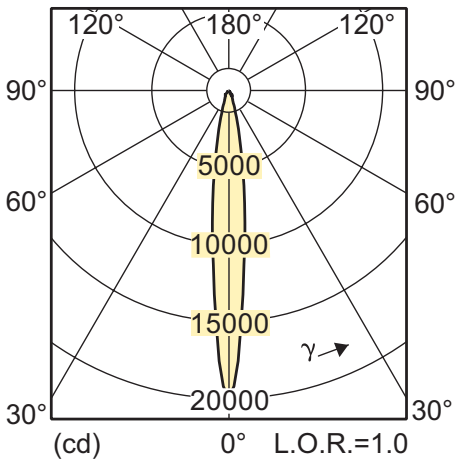

CDM-Rm 35W /930 10D

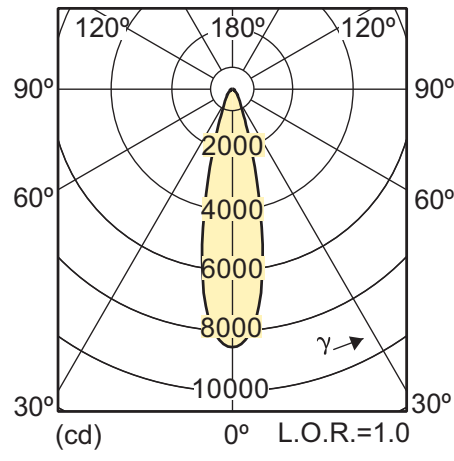

CDM-Rm 35W /930 25D

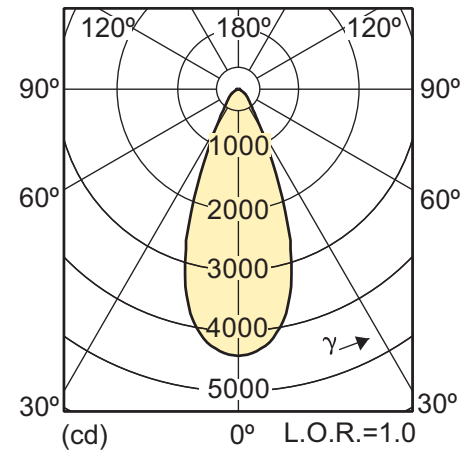

CDM-Rm 35W /930 40D

Electrical Characteristics

Order code	Full product name	Lamp Wattage	Lamp Wattage EM	Lamp Wattage EM 25°C, Rated	Lamp Wattage EL	Lamp Wattage EL 25°C, Rated	Lamp Voltage	Lamp Current EM	Lamp Current EL	Dimmable	Warm-up Time to 60% Light Outp
928193205330	MASTERColour CDM-Rm Elite Mini 50W/930 GX10 MR16 25D	50 W	W	W	50 W	50.0 W	89 V	A	0.575 A	No	120 s
928193305330	MASTERColour CDM-Rm Elite Mini 50W/930 GX10 MR16 40D	50 W	W	W	50 W	50.0 W	89 V	A	0.575 A	No	120 s
928194705330	MASTERColour CDM-Rm Elite Mini 35W/930 GX10 MR16 25D	35 W	W	W	35 W	39.0 W	87 V	A	0.450 A	No	120 s
928194805330	MASTERColour CDM-Rm Elite Mini 35W/930 GX10 MR16 40D	35 W	W	W	35 W	39.0 W	87 V	A	0.450 A	No	120 s
928194605330	MASTERColour CDM-Rm Elite Mini 35W/930 GX10 MR16 10D	35 W	W	W	35 W	39.0 W	87 V	A	0.450 A	No	120 s
928193105330	MASTERColour CDM-Rm Elite Mini 50W/930 GX10 MR16 60D	50 W	W	W	50 W	50.0 W	89 V	A	0.575 A	No	120 s

Performance diagrams

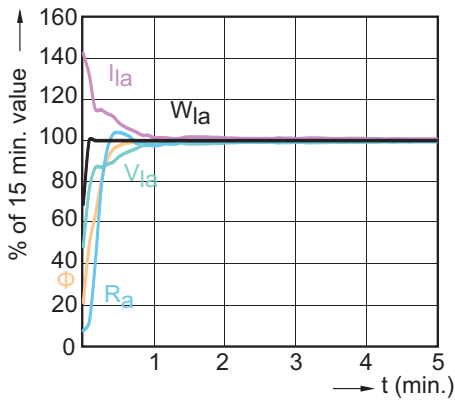

CDM-Rm 50W /930

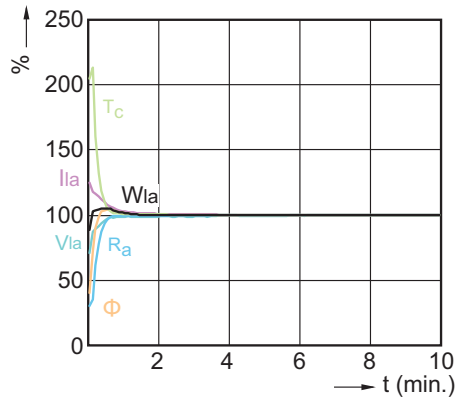

CDM-Rm 35W /930

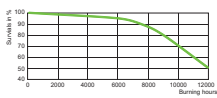

CDM-Rm 50W /930

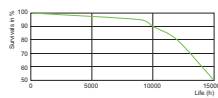

CDM-Rm 35W /930

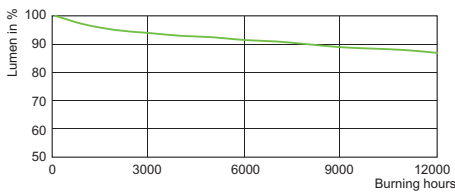

CDM-Rm 50W /930

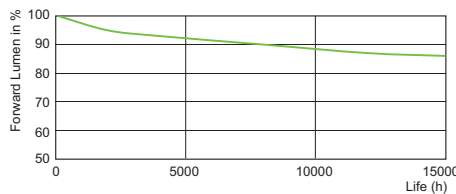

CDM-Rm 35W /930

Environmental Characteristics

Order code	Full product name	Energy Efficiency Label (EEL)	Mercury (Hg) Content	Energy consumption kWh/1000h
928193205330	MASTERColour CDM-Rm Elite Mini 50W/930 GX10 MR16 25D	A	6.4 mg	55 kWh
928193305330	MASTERColour CDM-Rm Elite Mini 50W/930 GX10 MR16 40D	A	6.4 mg	55 kWh
928194705330	MASTERColour CDM-Rm Elite Mini 35W/930 GX10 MR16 25D	A	4.7 mg	43 kWh
928194805330	MASTERColour CDM-Rm Elite Mini 35W/930 GX10 MR16 40D	A	4.7 mg	43 kWh
928194605330	MASTERColour CDM-Rm Elite Mini 35W/930 GX10 MR16 10D	A	4.7 mg	43 kWh
928193105330	MASTERColour CDM-Rm Elite Mini 50W/930 GX10 MR16 60D	A	6.4 mg	55 kWh

Measuring Conditions

Order code	Full product name	Switching cycle
928193205330	MASTERColour CDM-Rm Elite Mini 50W/930 GX10 MR16 25D	1000X
928193305330	MASTERColour CDM-Rm Elite Mini 50W/930 GX10 MR16 40D	1000X
928194705330	MASTERColour CDM-Rm Elite Mini 35W/930 GX10 MR16 25D	1350X
928194805330	MASTERColour CDM-Rm Elite Mini 35W/930 GX10 MR16 40D	1350X
928194605330	MASTERColour CDM-Rm Elite Mini 35W/930 GX10 MR16 10D	1350X
928193105330	MASTERColour CDM-Rm Elite Mini 50W/930 GX10 MR16 60D	1000X

Luminaire Design Requirements

Order code	Full product name	Cap-Base Temperature	Bulb Temperature
928193205330	MASTERColour CDM-Rm Elite Mini 50W/930 GX10 MR16 25D	C	C
928193305330	MASTERColour CDM-Rm Elite Mini 50W/930 GX10 MR16 40D	C	C



Order code	Full product name	Cap-Base Temperature	Bulb Temperature
928194705330	MASTERColour CDM-Rm Elite Mini 35W/930 GX10 MR16 25D	C	C
928194805330	MASTERColour CDM-Rm Elite Mini 35W/930 GX10 MR16 40D	C	C
928194605330	MASTERColour CDM-Rm Elite Mini 35W/930 GX10 MR16 10D	C	C

Order code	Full product name	Cap-Base Temperature	Bulb Temperature
928193105330	MASTERColour CDM-Rm Elite Mini 50W/930 GX10 MR16 60D	C	C



© 2013 Koninklijke Philips N.V. (Royal Philips)  
All rights reserved.

Specifications are subject to change without notice. Trademarks are the property of Koninklijke Philips N.V. (Royal Philips) or their respective owners.

[www.philips.com/lighting](http://www.philips.com/lighting)

2013, November 6  
data subject to change