

MR16 7.5W



OUTPUT RANGE: VIVID SERIES	390 - 455 lumen
OUTPUT RANGE: BRILLIANT SERIES	475 - 525 lumen
BEAM ANGLE RANGE	10°, 25°, 36°
COLOR TEMPERATURE RANGE	2700K, 3000K, 4000K, 5000K
APPLICATION	Halogen replacement for indoor & outdoor applications



POINT SOURCE OPTICS

Exceptional beam control enables unique 10° narrow spot and smooth uniform beams

Single light source, single crisp shadow

VP₃ VIVID COLOR & VP₃ NATURAL WHITE

VIVID series provides accurate color rendering across the visible spectrum from 400nm to 700nm, with CRI/95*, R9/95*, Rf/90, Rg/100

Whiteness rendering matches or exceeds that of halogen and incandescent sources at 2700K and 3000K

ENERGY EFFICIENCY & LONG LIFE

85% more energy efficient than standard halogen lamps

Typical payback of one year or less

Rated lifetime of 35,000 hours. 3 year warranty

CERTIFICATIONS

UL/CUL Class 2 and non-Class 2, FCC Title 47 Part 15B, RoHS, CE



HIGHLY COMPATIBLE

Narrow spot compatible with Soraa SNAP System accessories

Geometrically compatible with standard fixtures and suitable for damp locations

This lamp is suitable for use in fully enclosed fixtures, subject to the maximum heatsink temperature limits stated in this data sheet. A list of qualified enclosed fixtures can be found at www.soraa.com/resources

Works with trailing edge and leading edge phase cut dimmers, 12V AC magnetic and electronic transformers and 12V DC transformers (see www.soraa.com/resources)

INTENDED USE AND APPLICATIONS

Intended for use in MR16 compatible recessed downlights, track lighting and other indoor and outdoor applications

Soraa lamps are designed to safely turn down in any thermal environment not conducive to minimum airflow or proper ventilation

GENERAL SPECIFICATIONS

Form Factor	Operating Temperature	Electrical	Dimming and Flicker
Width: 50.1mm (1.97")	Minimum: -40°C (ambient)	Wattage: 7.5W	Dimmable to <20%
Height: 45.5mm (1.79")	Typical: 85°C - 95°C (base)	Power factor: 0.92	Flicker Index: 0.02
Weight: 47g	Maximum: 100°C (base)	Voltage: 12V +/- 1.2V	Percent Flicker: 5%
		Frequency: 50/60Hz	

*Metrics apply to 2700K, 3000K, 4000K. 5000K color metrics are CRI/90, R9/95

DIMENSIONS

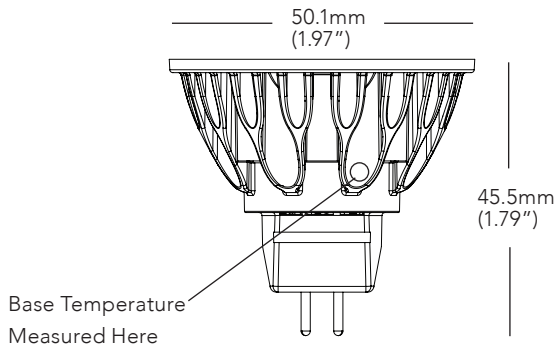

COLOR RENDERING

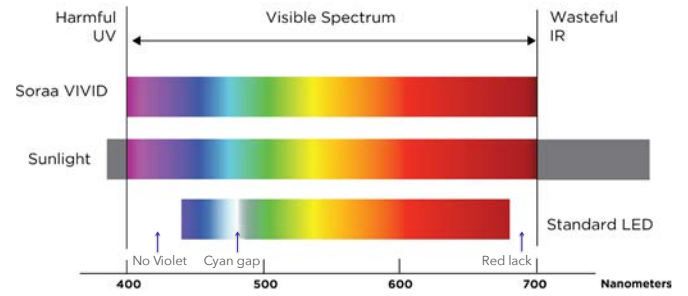

10 DEGREE BEAM

Beam Dia at 50% CBCP (ft)	Field Dia at 10% CBCP (ft)	Foot-candles (% of CBCP)
0.5	1.1	11.1%
1.0	2.1	2.8%
1.6	3.2	1.2%
2.1	4.2	0.7%
2.6	5.3	0.4%

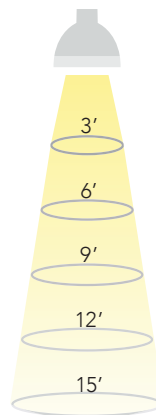

25 DEGREE BEAM

Beam Dia at 50% CBCP (ft)	Field Dia at 10% CBCP (ft)	Foot-candles (% of CBCP)
1.3	2.2	11.1%
2.7	4.4	2.8%
4.0	6.6	1.2%
5.3	8.7	0.7%
6.7	10.9	0.4%

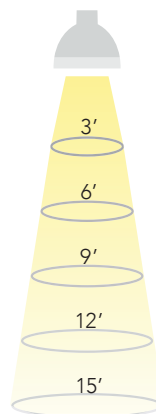

36 DEGREE BEAM

Beam Dia at 50% CBCP (ft)	Field Dia at 10% CBCP (ft)	Foot-candles (% of CBCP)
1.9	3.3	11.1%
3.9	6.5	2.8%
5.8	9.8	1.2%
7.8	13.0	0.7%
9.7	16.3	0.4%

Note: Footcandles may be calculated by multiplying the CBCP of the desired model number by the percentage in the tables above

SPECIFICATIONS BY MODEL NUMBER* SORAA LED MR16 7.5W

Model #	Product Code	CCT (K)	Beam Angle	CBCP (Cd)	Halogen Equivalent	Total Flux (Lm)	Efficacy (Lm/W)	McA	Energy Star	SNAP
VIVID SERIES										
SM16-07-10D-927-03	00919	2700	10	5710	50	390	52	3	YES	YES
SM16-07-25D-927-03	00931	2700	25	2260	50	410	55	3	YES	-
SM16-07-36D-927-03	00943	2700	36	1070	50	410	55	3	YES	-
SM16-07-10D-930-03	00923	3000	10	6000	50	410	55	3	-	YES
SM16-07-25D-930-03	00935	3000	25	2400	50	435	58	3	YES	-
SM16-07-36D-930-03	00947	3000	36	1130	50	435	58	3	YES	-
SM16-07-10D-940-03	00925	4000	10	6290	50	430	57	4	YES	YES
SM16-07-25D-940-03	00937	4000	25	2510	50	455	61	4	YES	-
SM16-07-36D-940-03	00949	4000	36	1190	50	455	61	4	YES	-
SM16-07-10D-950-03	00927	5000	10	6290	50	430	57	5	YES	YES
SM16-07-25D-950-03	00939	5000	25	2510	50	455	61	5	-	-
SM16-07-36D-950-03	00951	5000	36	1190	50	455	61	5	-	-
BRILLIANT SERIES										
SM16-07-10D-827-03	00917	2700	10	6950	50	475	63	3	YES	YES
SM16-07-25D-827-03	00929	2700	25	2760	50	500	67	3	YES	-
SM16-07-36D-827-03	00941	2700	36	1310	50	500	67	3	YES	-
SM16-07-10D-830-03	00921	3000	10	7320	50	500	67	3	-	YES
SM16-07-25D-830-03	00933	3000	25	2900	50	525	70	3	YES	-
SM16-07-36D-830-03	00945	3000	36	1370	50	525	70	3	YES	-

CCT: Correlated Color Temperature **McA:** White Point Accuracy in McA step **SNAP:** SORAA SNAP System Compatible

*Specifications are at stable warm operating conditions (25°C ambient)

SERIES/CCT

COLOR ACCURACY

WHITENESS INDEX

SPECTRAL POWER DISTRIBUTION

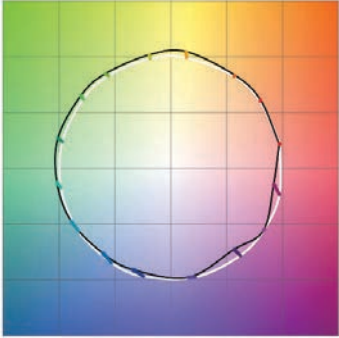
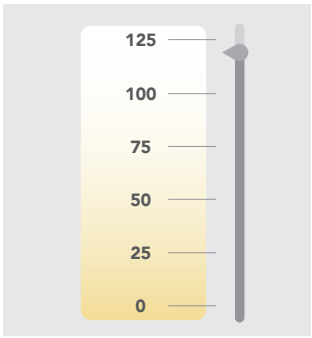
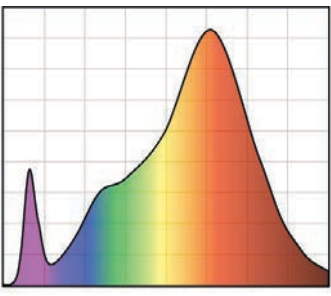
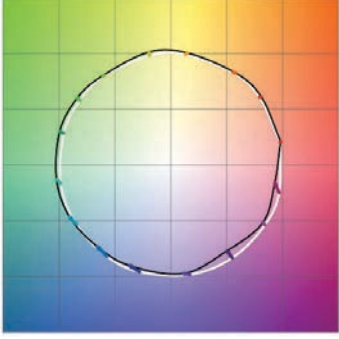
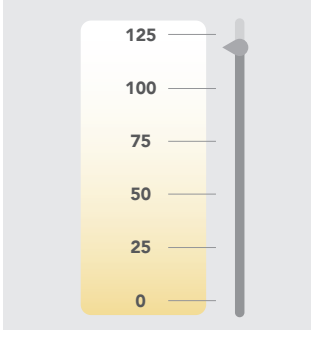
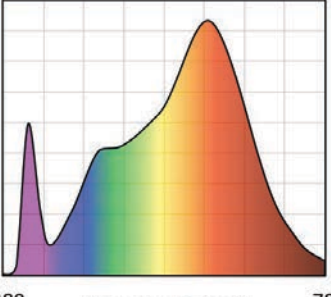
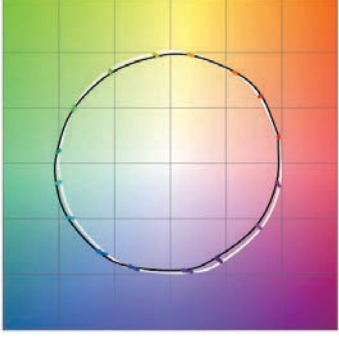
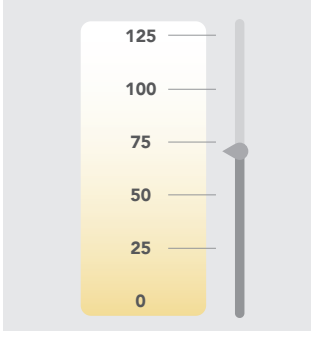
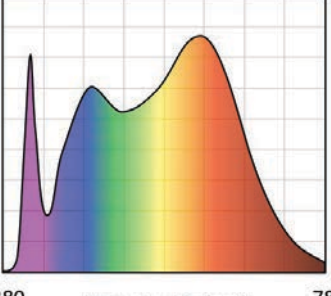
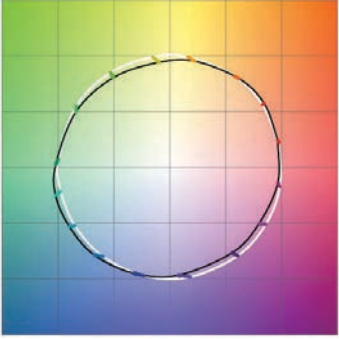
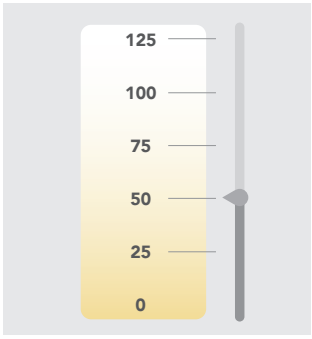
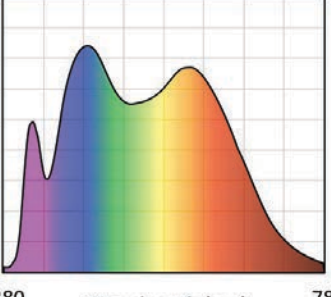
<p>VIVID 2700K</p>	 <p>Rf: 90, Rg: 100, Rfh1: 95</p>	 <p>Rw: 120</p>	 <p>380 Wavelength (nm) 780</p> <p>CRI: 95, R9: 95</p>
<p>VIVID 3000K</p>	 <p>Rf: 90, Rg: 100, Rfh1: 95</p>	 <p>Rw: 120</p>	 <p>380 Wavelength (nm) 780</p> <p>CRI: 95, R9: 95</p>
<p>VIVID 4000K</p>	 <p>Rf: 90, Rg: 100, Rfh1: 95</p>	 <p>Rw: 70</p>	 <p>380 Wavelength (nm) 780</p> <p>CRI: 95, R9: 95</p>
<p>VIVID 5000K</p>	 <p>Rf: 90, Rg: 100, Rfh1: 95</p>	 <p>Rw: 50</p>	 <p>380 Wavelength (nm) 780</p> <p>CRI: 90, R9: 95</p>

SERIES/CCT

COLOR ACCURACY

WHITENESS INDEX

SPECTRAL POWER DISTRIBUTION

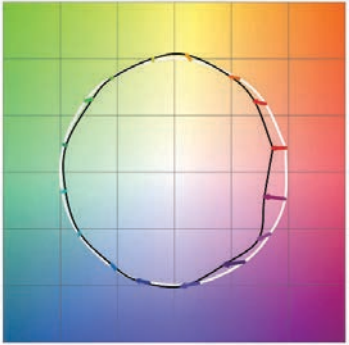
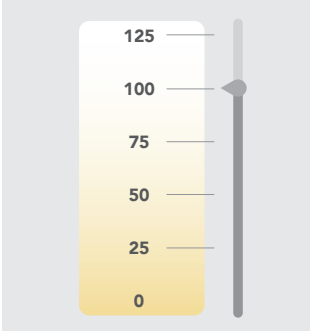
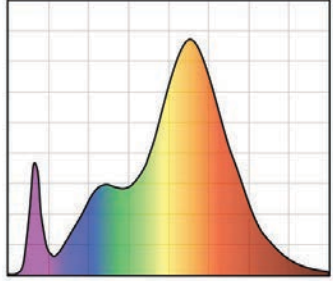
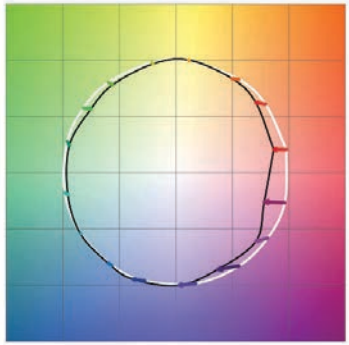
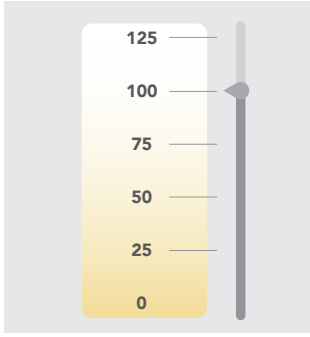
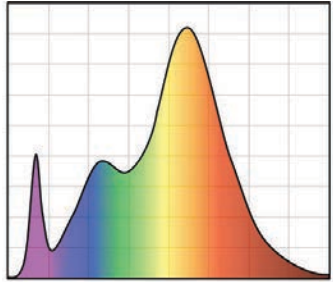
<p>BRILLIANT 2700K</p>	 <p>Rf: 85, Rg: 92, Rfh1: 77</p>	 <p>Rw: 100</p>	 <p>CRI: 85, R9: >0</p>
<p>BRILLIANT 3000K</p>	 <p>Rf: 85, Rg: 92, Rfh1: 77</p>	 <p>Rw: 100</p>	 <p>CRI: 85, R9: >0</p>

Rf: TM-30 metric measuring color fidelity (whether colors are similar to those under natural light). Rf is a more accurate version of the CRI Ra. Rf is 100 for natural light.
 Rg: TM-30 metric measuring color gamut (whether colors are more saturated than under natural light). Rg is 100 for natural light.
 Rfh1: TM-30 metric measuring color fidelity for red tones. Rfh1 is a more accurate version of the CRI R9. Rfh1 is 100 for natural light.
 Rw: Soraa-developed metric to measure white fidelity. Rw measures the magnitude of excitation of whitening agents within whites. Rw is about 100 for natural light.