

ELECTRONIC HID BALLASTS



ELECTRONIC HID



Contents

General Information	4-2
e-Vision®	4-3 to 4-7
DynaVision®	4-8 to 4-10

Corporate Offices
(800) 322-2086

Customer Support/Technical Service
(800) 372-3331 • (+) 1 847 390-5000 (International)

Visit our web site at www.advancetransformer.com



Electronic HID Overview

Just as electronic ballast technology enhanced fluorescent lighting systems, electronic HID ballasts bring significant performance improvements to HID lighting systems:

- Higher efficiency
- Greater lumen maintenance
- Longer lamp life
- Enhanced color control

Low frequency electronic ballasts are recommended by lamp manufacturers to drive the new generation of ceramic, low wattage metal halide lamps. These ceramic lamps have superior color rendition and can potentially maintain that color over the life of the lamps. However, as color is a function of lamp wattage, the ballast must be able to maintain lamp wattage precisely at its rated point throughout the entire life of the lamp. Low frequency electronic HID ballasts such as Advance Transformer's e-Vision® line constantly measure and adjust the wattage, optimizing delivery of the ceramic lamps' superior color properties. This makes metal halide a viable choice for many applications previously lit by either tungsten halogen or incandescent sources, such as retail lighting.

Operational improvements are gained as greater efficiency and cooler running electronic ballasts lead to energy savings. In addition, ballasts run quieter, weigh less and have compact footprints.

Improved lumen maintenance – the lamp/ballast system's ability to minimize light output depreciation over the life of the lamp – is the most fundamental and significant benefit of electronic HID ballasts, especially medium wattage, high frequency ballasts such as Advance's DynaVision® ballast. DynaVision delivers a 30-50% improvement in lumen maintenance over conventional HID systems (magnetic ballasts driving probe-start metal halide lamps) and a 19% improvement over pulse-start systems. Conventional HID systems typically experience a 50-60% fall-off in light output over the published life of the lamp. By maintaining higher light levels across the entire published life of the lamp, electronic HID ballasts reduce the need for frequent re-lamping.

With more maintained lumens the overall fixture count can be significantly reduced. For example, a 400w DynaVision system produces up to 56% more mean lumens over a 400w probe-start system with magnetic ballasts. Taking advantage of this performance benefit, the fixture count can be reduced by up to 36% without sacrificing light levels. Fewer fixtures also lead to much lower operating costs in terms of both energy savings and maintenance.

Dimming (to 50% power) with lighting controls such as relays, occupancy sensors, building management systems (BMS) and, other 0-10V Controls.

The DynaVision ballast also incorporates microprocessor-based technology which provides comprehensive lamp and ballast parameter control and is a solid platform for the future.

e-Vision® LOW FREQUENCY ELECTRONIC HID BALLASTS For Low Wattage HID Lamps

E-HID Lead Wire Information

Wire Color	Function	Lengths Lead (-LF model)	Lengths (-BLS model)	Length Strip
Black	Input Power	11.0" +/- 1.0"	9.0" +3.0"/-2.0"	0.5"
White	Input Power	11.0" +/- 1.0"	9.0" +3.0"/-2.0"	0.5"
Black/White	Lamp Power Selection (IMH50A and IMH100A models only)	11.0" +/- 1.0"	9.0" +3.0"/-2.0"	0.5"
Red	Lamp Base	11.0" +/- 1.0"	9.0" +3.0"/-2.0"	0.5"
Blue	Lamp Screwshell	11.0" +/- 1.0"	9.0" +3.0"/-2.0"	0.5"
Green	Ground	11.0" +/- 1.0"	9.0" +3.0"/-2.0"	0.5"
Orange	Lamp Base	11.0" +/- 1.0"	9.0" +3.0"/-2.0"	0.5"
Brown	Lamp Screwshell	11.0" +/- 1.0"	9.0" +3.0"/-2.0"	0.5"
Yellow	Output for 120V Self Heating Thermal protector	N/A	9.0" +3.0"/-2.0"	0.5"
Gray with Red Stripe	Output for 120V Self Heating Thermal protector	N/A	9.0" +3.0"/-2.0"	0.5"

Key Features	Key Benefits
IntelliVolt® • Operates on either 120 or 277 volts, or any voltage in between, 50 or 60 Hz	<ul style="list-style-type: none"> • Fewer SKUs required in inventory • Broadens the range of applications
Smaller and lighter weight than magnetic HID F-Can ballasts	<ul style="list-style-type: none"> • Compact electronic HID footprints • Provides greater design flexibility
Reduced input watts compared to magnetic systems	<ul style="list-style-type: none"> • Energy Savings; Lower cost of ownership
Low frequency lamp operation	<ul style="list-style-type: none"> • Prevents acoustic resonance in the lamp arc tube • Recommended by lamp manufacturers
Square wave output waveform	<ul style="list-style-type: none"> • Maximizes lamp life
Lamp EOL detection; Safely shuts down system at lamp end of life	<ul style="list-style-type: none"> • Enhanced safety
Thermally protected, internally fused, and output short circuit protected	<ul style="list-style-type: none"> • Safely shuts system down upon abnormal failure or conditions
Excellent lamp wattage regulation • Lamp wattage will change less than .5% with a +/-10% change in line voltage	<ul style="list-style-type: none"> • Better light quality • Optimizes lamp color stability over life • Reduces lamp-to-lamp color variations both initially and during lamp life
Metallic enclosure	<ul style="list-style-type: none"> • Provides enhanced capability for high ambient temperatures by transferring heat away from sensitive internal components
1.0 Ballast Factor	<ul style="list-style-type: none"> • Lamp produces maximum light output over its entire life.

e-Vision Electronic Ballast Catalog Number Explanation

I	ZT	-	MH	-	100	-	A	-	BLS	-	ID	Additional Options: ID = Integral 120V output to supply power to a Self Heating Thermal Protector Blank = None							
<p>Lead Exit / Mounting Options: BLS = Bottom Leads with Studs LF = Leads (side exit) with mounting Feet LFS = Leads (side exit, lead exit from same end) with mounting Feet (RMH-20-K and RMH-39-K Only)</p>																			
<p>Can Material / Size: (Dimensions include mounting feet)</p> <table border="0"> <tr> <td>A = Metal case with dim. 5.5" L x 3.6" W x 1.5" H</td> <td>G = Metal case with dim. 3.9" L x 3.0" W x 1.2" H</td> </tr> <tr> <td>C = Metal case with dim. 8.0" L x 3.6" W x 1.5" H</td> <td>H = Metal case with dim. 6.4" L x 3.7" W x 1.5" H</td> </tr> <tr> <td>D = Metal case with dim. 5.0" L x 3.0" W x 1.5" H</td> <td>J = Metal case with dim. 5.9" L x 1.8" W x 1.2" H</td> </tr> <tr> <td>E = Metal case with dim. 5.5" L x 1.75" W x 1.2" H</td> <td>K = Metal case with dim. 4.75" L x 1.3" W x 1.2" H</td> </tr> </table>												A = Metal case with dim. 5.5" L x 3.6" W x 1.5" H	G = Metal case with dim. 3.9" L x 3.0" W x 1.2" H	C = Metal case with dim. 8.0" L x 3.6" W x 1.5" H	H = Metal case with dim. 6.4" L x 3.7" W x 1.5" H	D = Metal case with dim. 5.0" L x 3.0" W x 1.5" H	J = Metal case with dim. 5.9" L x 1.8" W x 1.2" H	E = Metal case with dim. 5.5" L x 1.75" W x 1.2" H	K = Metal case with dim. 4.75" L x 1.3" W x 1.2" H
A = Metal case with dim. 5.5" L x 3.6" W x 1.5" H	G = Metal case with dim. 3.9" L x 3.0" W x 1.2" H																		
C = Metal case with dim. 8.0" L x 3.6" W x 1.5" H	H = Metal case with dim. 6.4" L x 3.7" W x 1.5" H																		
D = Metal case with dim. 5.0" L x 3.0" W x 1.5" H	J = Metal case with dim. 5.9" L x 1.8" W x 1.2" H																		
E = Metal case with dim. 5.5" L x 1.75" W x 1.2" H	K = Metal case with dim. 4.75" L x 1.3" W x 1.2" H																		
<p>Maximum Lamp Wattage</p> <table border="0"> <tr> <td>20 = 22W Lamp (Philips MiniMaster Color Lamp)</td> <td>39 = 39W Lamp</td> <td>50 = 50W Lamp</td> <td>70W = 70W Lamp</td> </tr> <tr> <td>100 = 100W Lamp</td> <td>150 = 100W Lamp</td> <td>175 = 175W Lamp</td> <td>200W = 200W Lamp</td> </tr> </table> <p>(Some ballasts are dual wattage - See product table)</p>												20 = 22W Lamp (Philips MiniMaster Color Lamp)	39 = 39W Lamp	50 = 50W Lamp	70W = 70W Lamp	100 = 100W Lamp	150 = 100W Lamp	175 = 175W Lamp	200W = 200W Lamp
20 = 22W Lamp (Philips MiniMaster Color Lamp)	39 = 39W Lamp	50 = 50W Lamp	70W = 70W Lamp																
100 = 100W Lamp	150 = 100W Lamp	175 = 175W Lamp	200W = 200W Lamp																
<p>Number of Lamps: Blank = 1 Lamp Operation 2 = (2) Lamp Operation</p>																			
<p>Primary Lamp Type: MH = Metal Halide WSN = Mini whiteSON (100W ONLY) SN = High Pressure Sodium</p>																			
<p>Dimming Scheme: Blank = Fixed Light Output ZT = 0-10V Dimming</p>																			
<p>Input Voltage: I = IntelliVolt (accepts input of 120 thru 277V, 50/60 Hz nominal) R = 120V, 50/60 Hz nominal</p>																			

ELECTRONIC HID
e-Vision®

e-Vision® Electronic Ballast Specifications

Section I - Physical Characteristics

1.0 The electronic ballast shall be furnished with integral, color-coded leads.

Section II - Performance Requirements

- 2.0 The electronic ballast shall be IntelliVolt® and operate from a nominal line voltage range of 120-277 volts, +/-10%, 50/60 Hz.
- 2.1 The electronic ballast input current shall have Total Harmonic Distortion (THD) of less than 15%.
- 2.2 The electronic ballast shall have a Power Factor greater than 90%.
- 2.3 The electronic ballast shall have a lamp end-of-life detection and shutdown circuit.
- 2.4 The electronic ballast shall be Sound Rated A.
- 2.5 The electronic ballast output frequency to the lamps shall be less than 200 Hz to prevent acoustic resonance inside the lamp arc tube and to minimize visible flicker.
- 2.6 The electronic ballast shall provide a "Lamp Current Crest Factor" of less than 1.5.
- 2.7 The electronic ballast shall be thermally protected to shut off when operating temperatures reach unacceptable levels.

Section III - Regulatory Requirements

- 3.0 The electronic ballast shall meet the requirements of the Federal Communications Commission rules and regulations, Title 47 CFR part 18, for Non-Consumer equipment.
- 3.1 The electronic ballast shall be Underwriters Laboratories (UL) Listed and CSA Certified where applicable.

Section IV - Other

- 4.0 The electronic ballast shall not contain Polychlorinated Biphenyl (PCB's).
- 4.1 The electronic ballast shall carry a three-year warranty from the date of manufacture for operation at marked maximum case temperature or less.
- 4.2 The manufacturer shall have a twenty-five year history of producing HID lamp ballasts for the North American market.
- 4.3 The electronic ballast shall be produced in a factory certified to ISO 9002 Quality System Standards

Installation Notes

- 1. Red lead must be connected to center terminal of lamp (for Edison, screw base lamps). Do not connect red or blue lead to neutral or ground.
- 2. Use 4.0 kV pulse rated lampholder. (Except where special lampholder is required, such as 22W Philips Mini MasterColor Lamp).
- 3. Maximum ballast-to-lamp distance is 5 ft. using typical wiring methods and materials. Additional distance up to 15 ft. may be possible using wire between lamp and ballast with a total measured capacitance of 100 picofarads or less. Consult Advance for application assistance.
- 4. Power mains must be cycled off and then on to reset ballast after failed lamps are replaced.

Ballast Hot Spot Location

Hot spot locations differ with each ballast model and are designated on the individual ballast labels. Consult ballast labels and ballast specification sheets for Hot Spot locations.

Enclosure Dimensions, Lead Lengths and Wiring Diagrams

Wiring Diag. 1

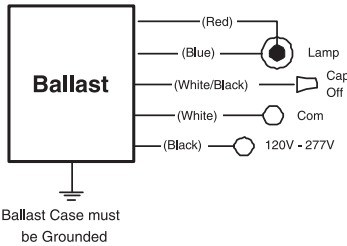

Wiring Diag. 2

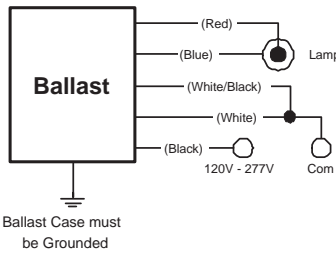

Wiring Diag. 3

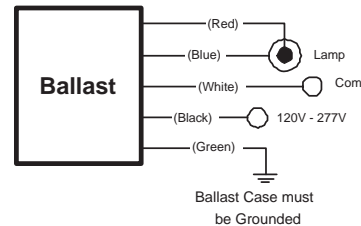

Wiring Diag. 4

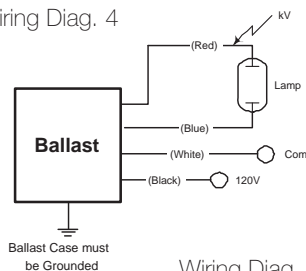

Wiring Diag. 5

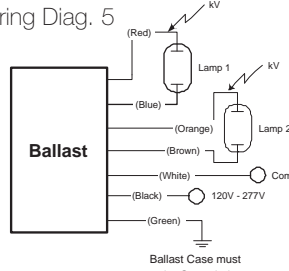

Wiring Diag. 6

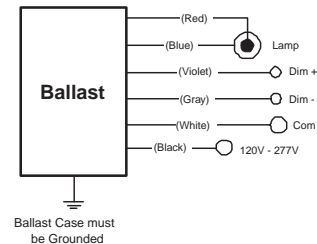

Wiring Diag. 8

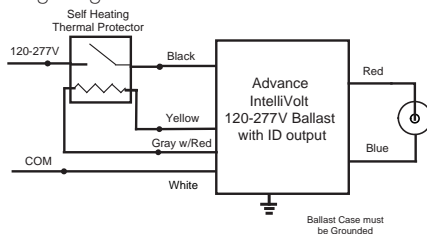

Metal Halide and High Pressure Sodium

Lamp Data		Input Volts	Catalog Number* Note 1	Certifications		Line Current (Amps)	Input Power ANSI (Watts)	Max. Case Temp. Note 6	Wiring Diag.	Fig.	Weight (lb)	Max. Distance to Lamp (ft)	
Number	Watts			UL	CSA								
22 Watt Lamp, Philips Mini MasterColor, ANSI Code M175, Minimum Starting Temp. -20°C/-4°F													
New	1	22	120	RMH-20-K-LF or RMH-20-K-LFS Note 2,8	✓	✓	0.23	26	90°C	4	K	0.5	6
	1	22	120	RMH-20-E-LF RMH-20-E-BLS	✓	✓	0.23	26	70°C	4	E	0.4	6
39 Watt Lamp, ANSI Code M130/C130, Minimum Starting Temp. -30°C/-20°F													
	1	39	120	RMH-39-K-LF or RMH-39-K-LFS Note 2,8,9	✓	✓	0.40	45	90°C	4	K	0.5	6
	1	39	120 277	IMH-39-G-LF or IMH-39-G-BLS	✓	✓	0.39	46	90°C	3	G	0.9	5
					✓	✓	0.18	45					
	1	39	120 277	IMH-39-J-LF	✓	✓	0.39	46	90°C	3	J	0.9	5
					✓	✓	0.18	45					
	1	39	120 277	IMH-50-A-LF or IMH-50-A-BLS Note 3	✓	✓	0.38	45	85°C	1	A	1.4	5
					✓	✓	0.16	44					
	2	39	120 277	IMH-239-A-LF or IMH-239-A-BLS	✓	✓	0.74	89	85°C	5	A	1.7	6
					✓	✓	0.31	89					
50 Watt Lamp, ANSI Code M110, Minimum Starting Temp. -30°C/-20°F													
	1	50	120 277	IMH-50-A-LF or IMH-50-A-BLS Note 3	✓	✓	0.47	56	85°C	2	A	1.4	5
					✓	✓	0.20	55					
70 Watt Lamp, ANSI Code M98 or M143 or M139, Minimum Starting Temp. -30°C/-20°F													
	1	70	120 277	IMH-70-G-LF or IMH-70-G-BLS	✓	✓	0.67	80	90°C	3	G	0.9	5
					✓	✓	0.30	79					
	1	70	120 277	IMH-70-J-LF	✓	✓	0.67	80	90°C	3	J	0.9	5
					✓	✓	0.30	79					
	1	70	120 277	IMH-70-D-LF or IMH-70-D-BLS	✓	✓	0.67	80	85°C	3	D	1.6	5
					✓	✓	0.29	79					
New	1	70	120 277	IMH-70-A-BLS-ID	✓	✓	0.72	86	90°C	8	A	1.6	6
					✓	✓	0.31	84					
	1	70	120 277	IMH-100-A-LF or IMH-100-A-BLS Note 4	✓	✓	0.68	82	85°C	1	A	1.4	5
					✓	✓	0.30	81					

Notes:

- All ballasts are sound rated A, and feature high power factor (>0.9, a ballast factor of 1.0 resettable thermal protection, and a maximum Harmonic Distortion of 15%.
- For RMH-39-K-LF and RMH-20-K-LF input and output lead wires exit on opposite sides of ballast. For RMH-39-K-LFS and RMH-20-K-LFS all lead wires exit the same side of the ballast.
- A dual-wattage ballast for 39W or 50W MH
- A dual-wattage ballast for 70W or 100W MH
- A dual-wattage ballast for 150W or 175W MH
- Maximum case temperature should not be exceeded in the application, as life will be affected and the integral re-settable thermal protector may activate. A lower maximum temperature rating does not imply lesser thermal performance, and can be indicative of a cooler running ballast design. Consult factory for further application assistance.
- Also operates (1) 150W HPS S56 (100V) Lamp
- Also operates the ES16 and ES36 SLI Brightspot lamps
- Also operates the 39W Philips miniMastercolor lamp (ANSI Code C179)

*** Ordering information:**

- LF Side exit leads with mounting feet
- BLS Bottom exit leads with mounting studs

For ballast diagrams see page 4-7

For lead wire information see page 4-2

Metal Halide and High Pressure Sodium

Lamp Data		Input Volts	Catalog Number* Note 1	Certifications		Line Current (Amps)	Input Power ANSI (Watts)	Max. Case Temp. Note 6	Wiring Diag.	Fig.	Weight (lb)	Max. Distance to Lamp (ft)
Number	Watts			UL	CSA							
100 Watt Lamp, ANSI Code M90 or M140, Minimum Starting Temp. -30°C/-20°F												
1	100	120	IMH-100-D-LF or IMH-100-D-BLS	✓	✓	0.92	110	85°C	3	D	1.6	5
		277		✓	✓	0.40	109					
1	100	120	IMH-100-A-LF or IMH-100-A-BLS Note 4	✓	✓	0.93	112	85°C	2	A	1.4	5
		277		✓	✓	0.40	110					
1	100	120	IMH-100-A-BLS-ID	✓	✓	0.96	115	90°C	8	A	1.4	6
		277				0.42	113					
150 Watt Lamp, ANSI Code M102 or M142, Minimum Starting Temp. -30°C/-20°F												
1	150	120	IMH-150-H-LF or IMH-150-H-BLS	✓	✓	1.4	165	85°C	3	H	1.9	5
		277		✓	✓	0.6	161					
1	150	120	IMH-175-C-LF or IMH-175-C-BLS Note 5,7	✓	✓	1.4	169	85°C	1	C	2.5	5
		277		✓	✓	0.6	166					
175 Watt Pulse Start Lamp, ANSI Code M137 or M152 (Pulse Start), Minimum Starting Temp. -30°C/-20°F												
1	175	120	IMH-175-C-LF or IMH-175-C-BLS Note 5	✓	✓	1.7	194	85°C	2	C	2.5	5
		277		✓	✓	0.7	191					
200 Watt Pulse Start Lamp, ANSI Code M136 (Pulse Start), Minimum Starting Temp. -30°C/-20°F												
1	200	120	IMH-200-C-LF	✓	✓	2.0	229	85°C	3	C	2.5	5
		277				1.0	219					
100 Watt Lamp, Philips Mini whiteSON (SDW-TG), ANSI Code S167 (Pulse Start), Min. Starting Temp. -20°C/-4°F												
1	100	120	IWSN-100-C-LF or IWSN-100-C-BLS	✓	✓	0.9	165	85°C	3	C	1.9	5
		277		✓	✓	0.5	161					

New

CONTROLLABLE BALLASTS WITH 0-10V DIMMING INTERFACE

Lamp Data		Input Volts	Catalog Number* Note 1	Certifications		Line Current (Amps)	Input Power ANSI (Watts)	Max. Case Temp. Note 6	Wiring Diag.	Fig.	Weight (lb)	Max. Distance to Lamp (ft)
Number	Watts			UL	CSA							
150 Watt Lamp, ANSI Code M102 or M142, Minimum Starting Temp. -30°C/-20°F												
1	150	120	IZTMH-150-C-LF	✓	✓	1.4	169	85°C	6	C	2.5	5
		277		✓	✓	0.6	166					
150 Watt HPS Lamp, ANSI Code S56 (100V), Minimum Starting Temp. -30°C/-20°F												
1	150	120	IZTSN-150-C-LF	✓	✓	1.4	169	85°C	6	C	2.5	5
		277		✓	✓	0.6	166					

Notes:

- All ballasts are sound rated A, and feature high power factor (>0.9, a ballast factor of 1.0 resettable thermal protection, and a maximum Harmonic Distortion of 15%.
- For RMH-39-K-LF and RMH-20-K-LF input and output lead wires exit on opposite sides of ballast. For RMH-39-K-LFS and RMH-20-K-LFS all lead wires exit the same side of the ballast.
- A dual-wattage ballast for 39W or 50W MH
- A dual-wattage ballast for 70W or 100W MH
- A dual-wattage ballast for 150W or 175W MH
- Maximum case temperature should not be exceeded in the application, as life will be affected and the integral re-settable thermal protector may activate. A lower maximum temperature rating does not imply lesser thermal performance, and can be indicative of a cooler running ballast design. Consult factory for further application assistance.
- Also operates (1) 150W HPS S56 (100V) Lamp
- Also operates the ES16 and ES36 SLI Brightspot lamps
- Also operates the 39W Philips miniMastercolor lamp

* Ordering information:
-LF Side exit leads with mounting feet
-BLS Bottom exit leads with mounting studs

For ballast diagrams see page 4-7

For lead wire information see page 4-2



e-Vision® LOW FREQUENCY ELECTRONIC HID BALLASTS

For Low Wattage Metal Halide Lamps

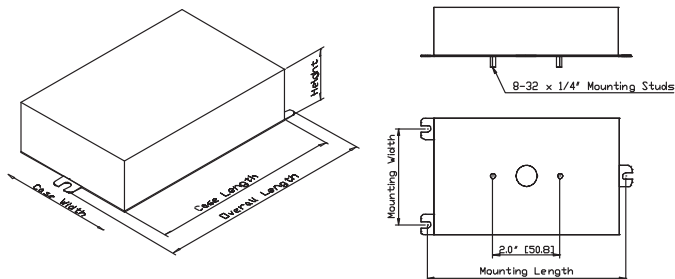

Case Figure	Overall Length	Case Length	Case Width	Height	Mounting Length	Mounting Width
A	140mm [5.5"]	120mm [4.7"]	92mm [3.6"]	38mm [1.5"]	132mm [5.2"]	73mm [2.9"]
C	204mm [8.0"]	184mm [7.2"]	92mm [3.6"]	38mm [1.5"]	195mm [7.7"]	73mm [2.9"]
H	161mm [6.3"]	144mm [5.7"]	92mm [3.6"]	38mm [1.5"]	152mm [6.0"]	73mm [2.9"]

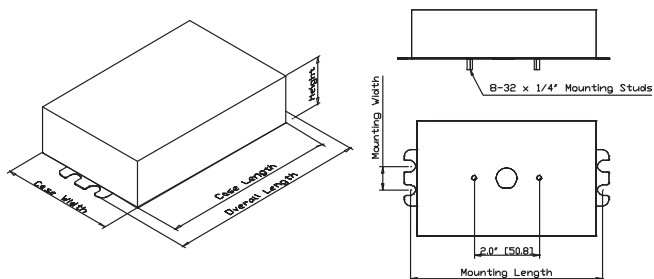

Case Figure	Overall Length	Case Length	Case Width	Height	Mounting Length	Mounting Width
D	128mm [5.0"]	108mm [4.3"]	77mm [3.0"]	38mm [1.5"]	118mm [4.6"]	19mm [0.7"]

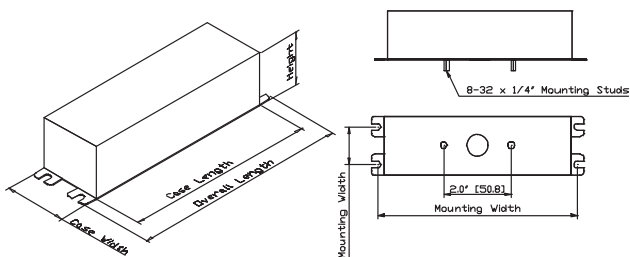

Case Figure	Overall Length	Case Length	Case Width	Height	Mounting Length	Mounting Width
E	140mm [5.5"]	127mm [5.0"]	44mm [1.7"]	30mm [1.2"]	135mm [5.3"]	26mm [1.0"]
J	149mm [5.9"]	140mm [5.5"]	46mm [1.8"]	30mm [1.2"]	145mm [5.7"]	27mm [1.0"]

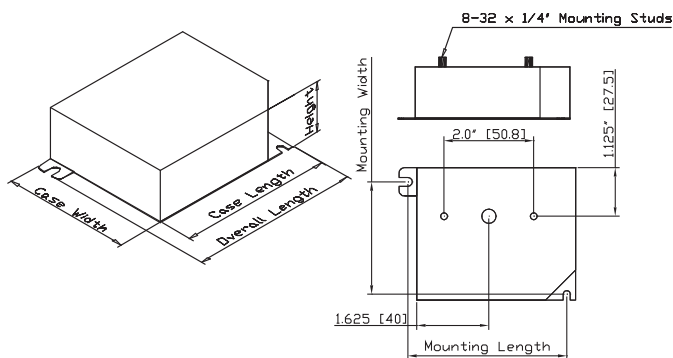

Case Figure	Overall Length	Case Length	Case Width	Height	Mounting Length	Mounting Width
G	97mm [3.8"]	90mm [3.5"]	77mm [3.0"]	30mm [1.2"]	87mm [3.4"]	67mm [2.6"]

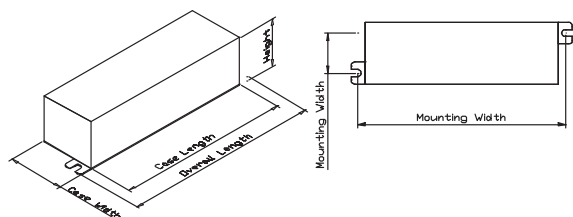

Case Figure	Overall Length	Case Length	Case Width	Height	Mounting Length	Mounting Width
K	113mm [4.4"]	104mm [4.1"]	33mm [1.1"]	30mm [1.2"]	13.5mm [0.5"]	114mm [4.5"]

ELECTRONIC HID
e-VISION®



DynaVision extends the key benefits of magnetic pulse-start metal halide systems — energy efficiency and white light. With its very-high frequency operation, as well as its on-board microprocessor and standard features, DynaVision provides numerous additional benefits and advantages.

DynaVision Features

Microprocessor technology
High frequency operation
True constant wattage

320/350/400 Tri-Wattage

IntelliVolt 200–277V 50/60 Hz

Integral 120V quartz tap and relay, 250W

0–10V dimming with automatic 15-minute warm up

0° to 55°C ambient rating standard
–30° to +40°C ambient rating optional

Lamp End-of-Life Protection (EOL)

Benefits and Advantages

Lower operating and maintenance costs
Fewer fixtures
Energy savings

Fewer SKU's
Less chance for error
Ease of change over to different wattage lamps

Standby-lighting ready
No special orders
No special relay or control required

Continuous dimming down to 50% power
Additional energy savings through daylight harvesting and occupancy sensing

Greater reliability, flexibility and applications opportunities

Safety

More about...

Standby Lighting Versatility

DynaVision's 120-volt output is designed to operate one quartz (incandescent) standby lamp up to 250W. The quartz lamp on or off modes are determined by the HID lamp's specific operating conditions. Once the HID lamp strikes, the quartz lamp automatically switches off when the HID lamp reaches 50% power.

Controllability

DynaVision is dimmable – down to 50% of nominal lamp power, with no noticeable loss in color characteristics. With 0–10V dimming, and compatible with a host of products from most control manufacturers, DynaVision brings new flexibility and energy-saving strategies, such as daylight harvesting and occupancy sensing, to applications in the industrial, educational, government, hospitality, commercial and retail sectors.

Physical Characteristics

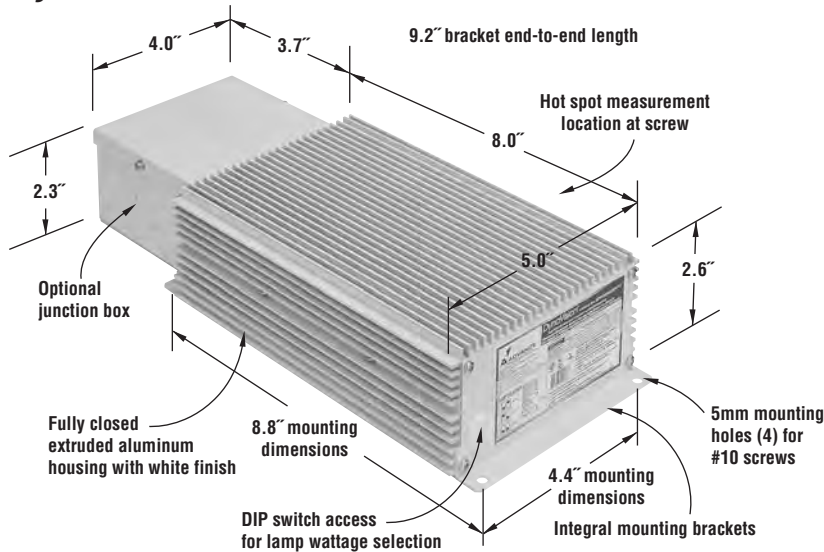

DynaVision™ Electronic Ballast Catalog Number Breakdown

IZTEMH4003PS - XJ

Basic Model Number

Options

I = IntelliVolt (200–277 50/60 Hz)

ZT = Zero-to-ten volt dimming

E = Electronic

MH = Metal Halide

400 = 400W maximum

3 = 3 wattage capability (320/350/400W)

PS = Pulse-Start

-XJ = Without junction box

(i.e. junction box is included if this suffix is omitted).

F = Low temperature version (–30° to+40°C)

DynaVision Electronic Ballast Specifications

Section I – Physical Characteristics

- 1.1 The electronic ballast shall be fully enclosed in an aluminum housing painted white.
- 1.2 The aluminum housing shall include a divided wiring compartment to separate the power leads from the control leads. All leads to be color-coded.

Section II – Performance Requirements

- 2.1 The electronic ballast shall be multivoltage capable and operate from a line voltage range of 180 – 305 volts, 50/60 Hz.
- 2.2 The electronic ballast shall incorporate a microprocessor controller to provide for optimum starting and operation of the HID lamp.
- 2.3 The electronic ballast input current shall have Total Harmonic Distortion (THD) of less than 15% when operated at nominal line voltage (200V, 208V, 230V, 240V, 277V).
- 2.4 The ballast shall incorporate a 0–10V dimming interface and control the dimming function such that the HID lamp is allowed to warm up for fifteen minutes at full power before the lamp will be allowed to dim, regardless of the level of the 0–10V signal. 10V applied to the dimming control leads, shall result in full light output. 0V applied, or shorting the control leads together, shall result in dimming to 50% of nominal lamp power.
- 2.5 The ballast shall include a 120V/250W auxiliary output for stand-by incandescent lighting that shall include an integral control to turn the auxiliary lamp on and off. The integral control shall include a time-delay feature to keep the auxiliary lamp on until the HID lamp reaches 50% power.
- 2.6 The electronic ballast shall have a Power Factor greater than 90%.
- 2.7 The electronic ballast shall have a lamp end-of-life detection and shutdown circuit.

- 2.8 The electronic ballast shall be Sound Rated A.
- 2.9 The electronic ballast output frequency to the lamps shall be higher than 100 kHz to prevent acoustic resonance inside the lamp arc tube and to minimize visible flicker.
- 2.10 The electronic ballast shall be thermally protected to shut off when operating temperatures reach unacceptable levels.

Section III – Regulatory Requirements

- 3.1 The electronic ballast shall meet the requirements of the Federal Communications Commission rules and regulations, Title 47 CFR part 18, for Non-Consumer equipment.
- 3.2 The electronic ballast shall be Underwriters Laboratories (UL) Listed and CSA Certified where applicable.

Section VI – Other

- 4.1 The electronic ballast shall not contain Polychlorinated Biphenyl (PCB's).
- 4.2 The electronic ballast shall carry a three-year warranty from the date of manufacture for operation at an ambient temperature of 55° C or less and when operated as a stand alone product (i.e. remotely from a lighting fixture housing). When operated within a lighting fixture housing, the same three-year warranty shall apply for a maximum ballast case hot spot temperature of 76° C or less.
- 4.3 The manufacturer shall have a twenty-five year history of producing HID lamp ballasts for the North American market.
- 4.4 The electronic ballast shall be produced in a factory certified to ISO 9002 Quality System Standards.

Installation and Application Notes

1. Red lead must be connected to center terminal of lamp. Do not connect red or blue lead to line neutral.
2. Setting precaution with triple-wattage feature: Do not operate lower wattage lamp on a ballast which has been set for operation of higher wattage lamp. Short lamp life may result.
3. Ballast output will shut off after 40 minutes maximum if lamp does not successfully ignite. Replace lamp and cycle mains to restore output.
4. Use 4.0 kV pulse rated lampholder.
5. Connect red lamp lead to 600Vrms, 3.5kV or UL style 1452 wire.
6. Remote mounting distances not exceeding 15 ft. are possible with normal wiring methods. For distances greater than 15 ft., power losses in the wire can result in appreciable decline in actual lamp operating power. Consult Advance for application assistance.
7. Mains must be cycled after replacing lamp.
8. Ballast output exceeds 100kHz. Suitable test equipment is required for measurement.
9. Ballast is suitable for recessed use. Do not install insulation above or within 3" of ballast sides.

Where to Measure the Ballast Hot Spot

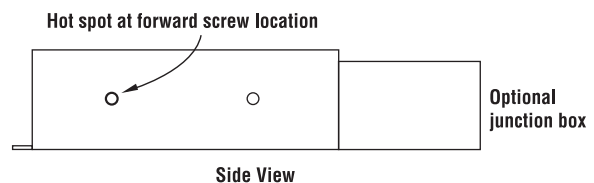



Breaks New Ground in HID Performance

Application Specifications

Pulse-Start Metal Halide

Lamp Data		Min Start Temp. (F/C)	Input Volts	Catalog Number	Listings	Line Current (A)	Input Power ANSI (W)	Ballast Factor	Max. THD %	Min. PF %	DIP Switch Settings
No.	Watts										



320 Watt Lamp, ANSI Code M132/M154

1	320	32/0	200 to 277	IZTEMH4003PS	 	1.8 @ 200V 1.3 @ 277V	345	1.0	15	90		↓ ON
		-20/-30		IZTEMH4003PS-F								

350 Watt Lamp, ANSI Code M131

1	350	32/0	200 to 277	IZTEMH4003PS	 	1.9 @ 200V 1.4 @ 277V	375	1.0	15	90		↓ ON
		-20/-30		IZTEMH4003PS-F								

400 Watt Lamp, ANSI Code M135/M155

1	400	32/0	200 to 277	IZTEMH4003PS	 	2.2 @ 200V 1.6 @ 277V	430	1.0	15	90		↓ ON
		-20/-30		IZTEMH4003PS-F								

NOTE: These specifications apply to operation of pulse-start metal halide lamps with quartz arc-tube construction only. For operating compatibility with ceramic arc-tube lamps, consult Advance.

DIP switches are "on" in the down position

Dimming Feature

With an integral, industry-standard 0-10V interface, the DynaVision™ electronic ballasts offer the capability to dim the lamp by lowering the wattage lamp, reducing energy consumption of the light fixture by up to 50%. Access to this interface is via the violet (+) and grey (-) dimming control leads. These leads can be connected to either a 0-10V dimming control, (DynaVision ballast are compatible with standard 0-10V control devices available from many manufacturers) a 0-10V DC power supply, or with a switch. An open switch provides full lamp power, and a closed switch, short-circuiting the 0-10V wires, yields 50% lamp power. Control devices such as relays and occupancy sensors may also be used.

A potentiometer may also be used. However, the value of the potentiometer is dependent on the number of ballasts connected. Consult Advance for guidance.

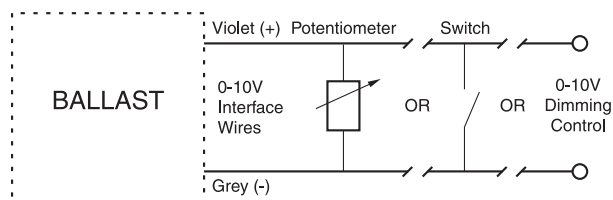

In accordance with the requirements of the HID lamp manufacturers and NEMA, the dimming feature includes a time delay to allow the HID lamp to warm up for 15 minutes at full power before the lamps will be allowed to dim, regardless of the level of the 0-10V signal.

Lead Wire Information

Wire Color	Function
Black	Input Power
White	Input Power
Green	Ground
Red	Lamp Eyelet
Blue	Lamp Screwshell
Yellow (2)	120V Lamp Output
Violet	0-10V Dimming (+)
Grey	0-10V Dimming (-)

All lead lengths are 11" +/- 1". The black & white (input power), green (ground), and red & blue (lamp) leads are pre-stripped 1/2". The two yellow 120v (output) and violet & grey (dimming control) leads have insulated ends.

Notes

