

# CIT Series

## Harsh Environment Enclosures



### FEATURES & SPECIFICATIONS

#### INTENDED USE

CITADEL 2™ offers more versatility than any other weatherproof enclosure offered in North America. Poured in place gasket and cam latches seal the enclosures. The Mounting System can provide dramatic savings on the installation labor. Designed around T8 and T5 lamps for long term energy savings. Very tough diffusers resist breakage.

#### SIZE W x L x H in inches (mm)

4.50W x 4.12H (115 x 105)

7.30W x 4.12H (185 x 105)

#### LAMP

1, 2, or 3 Lamp Positions in Cross section.

#### MATERIALS & FEATURES

One-piece compression-molded polyester fiberglass housing with polycarbonate latches. Seamless continuously bonded poured-in-place polyurethane gasketing. Ballast/component tray attaches fixture body with pinch-release clips. 1/2" conduit entry hole in each end of housing with weathertight plug.

- Stainless steel latch with "keeper" (optional).
- Latches can be tamper proof with #6 screw.

#### DIFFUSER

High reflectance component tray reflector. 100% Impact modified UV stabilized acrylic linear ribbed lens with smooth exterior face for easy cleaning.

#### MOUNTING

Durable stainless steel mounting hardware. No holes ever have to be drilled through the housing for installation. Installation time is dramatically reduced. Optional stainless steel bail for chain hung installations.

#### LISTING / CERTIFICATIONS

Fixture & Ballast: UL Listed, Wet Area

Ballast: Thermally protected, class P, HPF, Non PCB

NSF: Splash Zone certified

IP67: Certified (immersion at 1m for 30 min.)

CUL

High Pressure Hose Down

IP 65

IP 66

Nema 4, 4X

Non-Metallic

UL1598 Damp Locations

UL1598 Wet Locations

### ORDERING INFORMATION

Example: CITLB232E120

CIT	LB	2 32	E120	
<b>Series</b>		<b>Lamp Count</b>		
CIT Enclosed Wet Location Spec Grade		1, 2, or 3 17    24 in. T8, 2 ft. nom. length 1, 2, or 3 14    22 in. T5, 2 ft. nom. length 1, 2, or 3 24    22 in. T5HO, 2 ft. nom. length 1, 2, or 3 32    48 in. T8, 4 ft. nom. length 1, 2, or 3 28    46 in. T5, 4 ft. nom. length 1, 2, or 3 54    46 in. T5HO, 4 ft. nom. length 2 or 3    32 8    48 in. T8, 8 ft. nom. length (tandem) 2 or 3    28 8    46 in. T5, 8 ft. nom. length (tandem) 2 or 3    54 8    46 in. T5HO, 8 ft. nom. length (tandem)	<b>Ballast &amp; Voltage [1]</b>	
<b>Lens</b>		<b>HiLume and LoLume ballasts available for T8 lamps only</b>		
LB    Linear Ribbed Acrylic PC    Polycarbonate			<b>Options [1]</b>	
			CITMBIL    Mounting bracket for 1 light CITMB2L    Mounting bracket for 2 or 3 light. (2 per fixture) TL    Tamper Resistant Latching Systems SL    Stainless steel latch TSL    Tamper Resistant Stainless latch	

\* For 1 Light matching 2 light wider body add "WD"

Catalog Number:

Notes:

# CIT Series

Harsh Environment Enclosures



## DIMENSIONS

All dimensions are inches. Specifications subject to change without notice.

### One Lamp

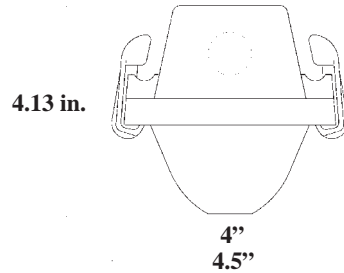

### Two or Three Lamp

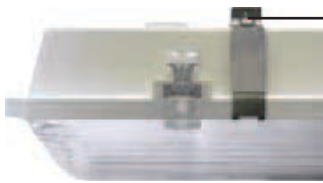
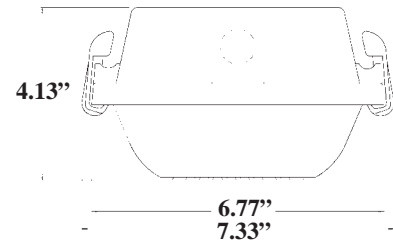

CITMB Accessory

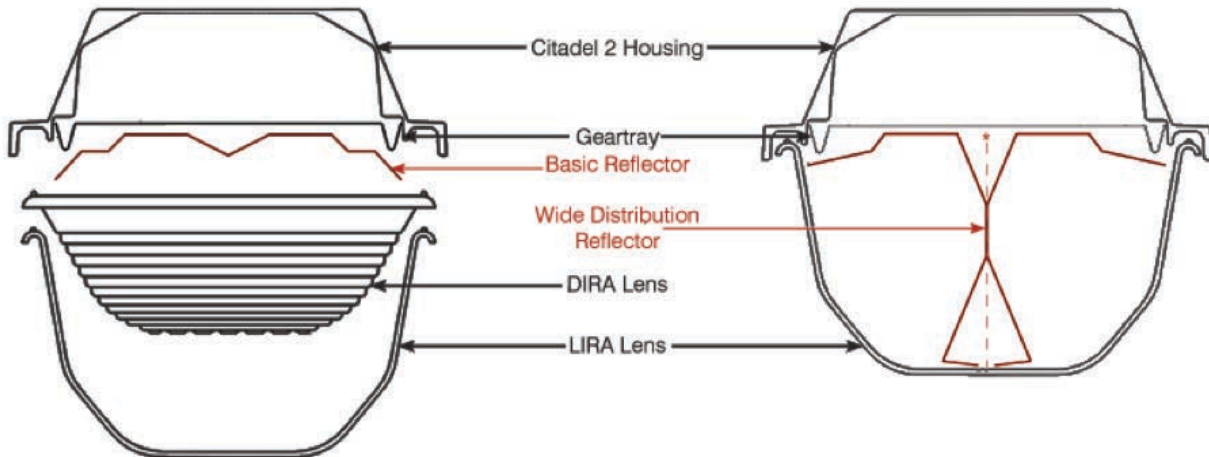
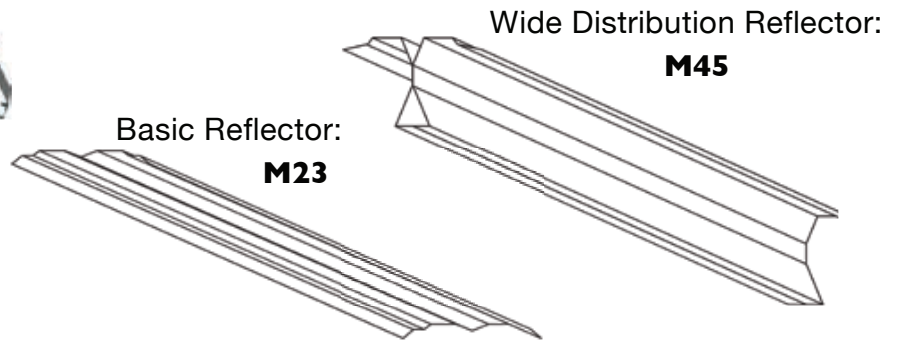

Optically Clear Lens (OL) with Basic Reflector:

**M23**



Optically Clear Lens (OL) with Wide Distribution Reflector:

**M45**

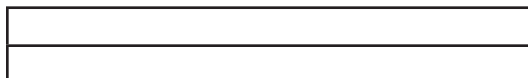

# CIT Series

## Harsh Environment Enclosures



### PHOTOMETRICS

Calculated using the zonal cavity method in accordance with IESNA LM41 procedure. Lamp configurations shown are typical. Photometric data on these and other configurations available upon request.

#### Candela Distribution

	0.0	22.5	45.0	67.5	90.0
0	1818	1818	1818	1818	1818
5	1811	1822	1850	1852	1861
15	1745	1812	1839	1843	1848
25	1625	1711	1743	1766	1768
35	1448	1531	1585	1651	1673
45	1211	1287	1402	1507	1538
55	911	1015	1182	1386	1441
65	569	698	946	1055	1090
75	226	423	628	823	877
85	29	192	412	579	625
90	12	109	293	443	502
95	11	55	214	335	395
105	6	9	79	128	144
115	0	0	22	56	68
125	0	0	2	15	25
135	0	0	0	1	6
145	0	0	0	0	0
155	0	0	0	0	0
165	0	0	0	0	0
175	0	0	0	0	0

Floor	20%	20%	20%	20%	20%	20%	20%	20%	20%	20%	20%	20%	20%	20%	20%	20%	20%	20%
Ceiling	80%	80%	80%	80%	70%	70%	70%	70%	50%	50%	50%	30%	30%	30%	10%	10%	10%	0%
Wall	70%	50%	30%	10%	70%	50%	30%	10%	50%	30%	10%	50%	30%	10%	50%	30%	10%	0%
		RCR				Zonal cavity coefficients				CIT254		Spacing ratio.		Along 1.2		Across 1.9		
0	81	81	81	81	79	79	79	79	79	75	75	75	71	71	71	67	67	66
1	73	69	65	62	70	67	64	61	63	61	58	60	58	56	57	55	53	52
2	65	59	54	49	63	57	53	48	54	50	47	51	48	45	49	46	44	42
3	59	51	45	40	57	50	44	40	47	42	38	45	41	37	43	39	36	34
4	54	45	39	34	52	44	38	33	42	36	32	40	35	32	38	34	31	29
5	50	40	34	29	48	39	33	28	37	32	28	35	31	27	34	30	26	25
6	46	36	29	25	44	35	29	25	33	28	24	32	27	24	31	26	23	21
7	42	32	26	22	41	32	26	22	30	25	21	29	24	21	28	24	20	19
8	39	30	23	19	38	29	23	19	28	22	19	27	22	18	25	21	18	17
9	37	27	21	17	35	26	21	17	25	20	17	24	20	17	23	19	16	15
10	34	25	19	16	33	24	19	15	23	19	15	23	18	15	22	18	15	13

#### Photometric Distribution Curve

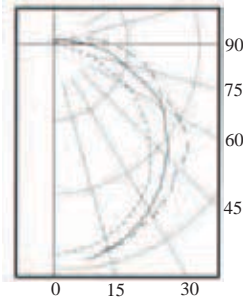

#### Luminance Data (CD/SQ. M)

	0-DEG	45-DEG	90-DEG
45	7605	7508	7885
55	6955	7259	8355
65	5762	7060	7535
75	3558	6213	7799
85	1100	6329	8136

