

SOLIDRIVE

CONSTANT VOLTAGE 0-10V DIMMABLE LED DRIVER



P/N: CVD96x24DC



The SoliDrive Series of Constant Voltage Class 2 LED Drivers from Magnitude Lighting offers both UL Listed and UL Recognized style enclosures. The UL Listed type enclosure has a built-in junction box on both the input and output. These drivers are IP65 rated and are suitable for both indoor and outdoor installations. With universal input voltage ranging from 120 to 277VAC, the SoliDrive series of drivers are designed for commercial, industrial and residential applications. Our 0-10V dimming delivers smooth flicker-free linear dimming down to 1% with most LED's and a wide variety of compatible dimmers. As always, 5-year warranty is a standard on all of Magnitude's products.

QUICK SPECS

Input Voltage	Max Output Power	Output Voltage	Output Current	Efficiency @ Max Load	THD @ Max. Load	Power Factor @ Max. Load	Envir. Protection Rating
120-277VAC	96W	24VDC	4100mA	> 87%	< 20%	> 0.95	IP65

WIRING DIAGRAM

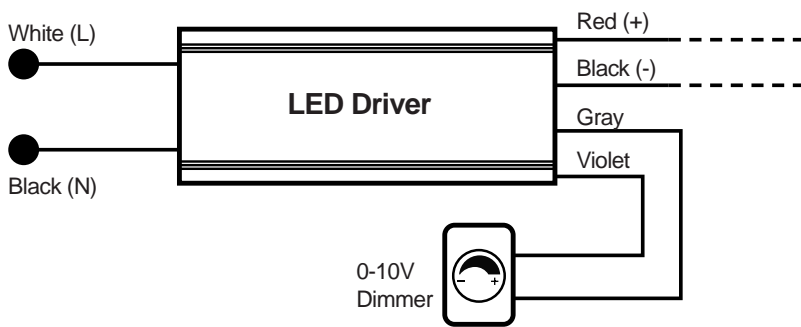

FEATURES

- UL Listed Enclosure – With Built-In Junction Boxes
- Universal Input Voltage
- 0-10V Dimmable - Flicker Free Down to 1%
- Ripple Free
- IP65 – For Both Indoor and Outdoor Use
- UL 8750 Approved
- Class 2, Class P
- Auto-Reset Protection for Short Circuit & Over-Temperature
- Over Load Protection – CC Mode

ENCLOSURE DETAILS In. (mm)

	L- With a Jbox	R-Without a Jbox
Length	11.4 (290.5)	6.8 (172)
Mounting Length	12.1 (307.9)	7.5 (191.6)
Width	2.36 (59.9)	2.36 (59.9)
Height	1.4 (35)	1.4 (35)

	L- With a Jbox	R-Without a Jbox
Driver Weight	30.95oz (878gram)	27.60oz (780gram)

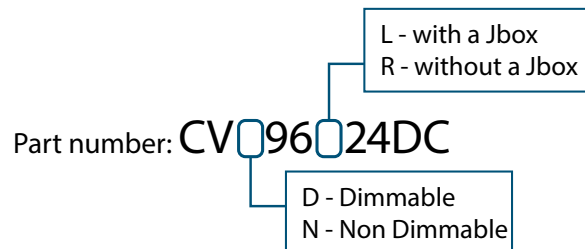

SPECIFICATIONS

Input

Input Voltage Range	120 - 277VAC \pm 10%
Input Frequency	50 / 60Hz
Input current	0.96A Max
Inrush Current	5A Max @ 120V / 23.7A Max @ 277V
Efficiency	> 87% Max
Power Factor	> 0.95
THD	< 20%

Output

Output Voltage	24VDC
Output Current	4100mA Max
Output Current Ripple	> 3%
Line Regulation	> 2%
Load Regulation	> 3%
Turn On Delay Time	> 0.3 Sec

Environmental Specification

Env. Protection Rating	IP65
Operating Ambient temperature	-25°C - +40°C
Max Case Temp. (Tcase)	65°C for a 5 year warranty
Storage temperature	-40°C - +85°C
Expected life time	50K Hours (> 65°C) Tc
Audible Noise	> 24db Class A

Dimming

Dimming Control	0-10V
Min. Dimming Level	1%
Dimming Curves	Linear
Current Consumption	0.35mA / Source

Protections Specification

Over Current Protection	Yes
Over Voltage Protection	Yes
Over Temperature Protection	Yes; Hiccup mode
Over Load Protection	Yes; CC mode
Short Circuit Protection	Yes; Hiccup mode

SOLIDRIVE CONSTANT VOLTAGE 0-10V DIMMABLE LED DRIVER

MECHANICAL DIAGRAM CVD96L24DC - ENCLOSURE WITH JUNCTION BOXES

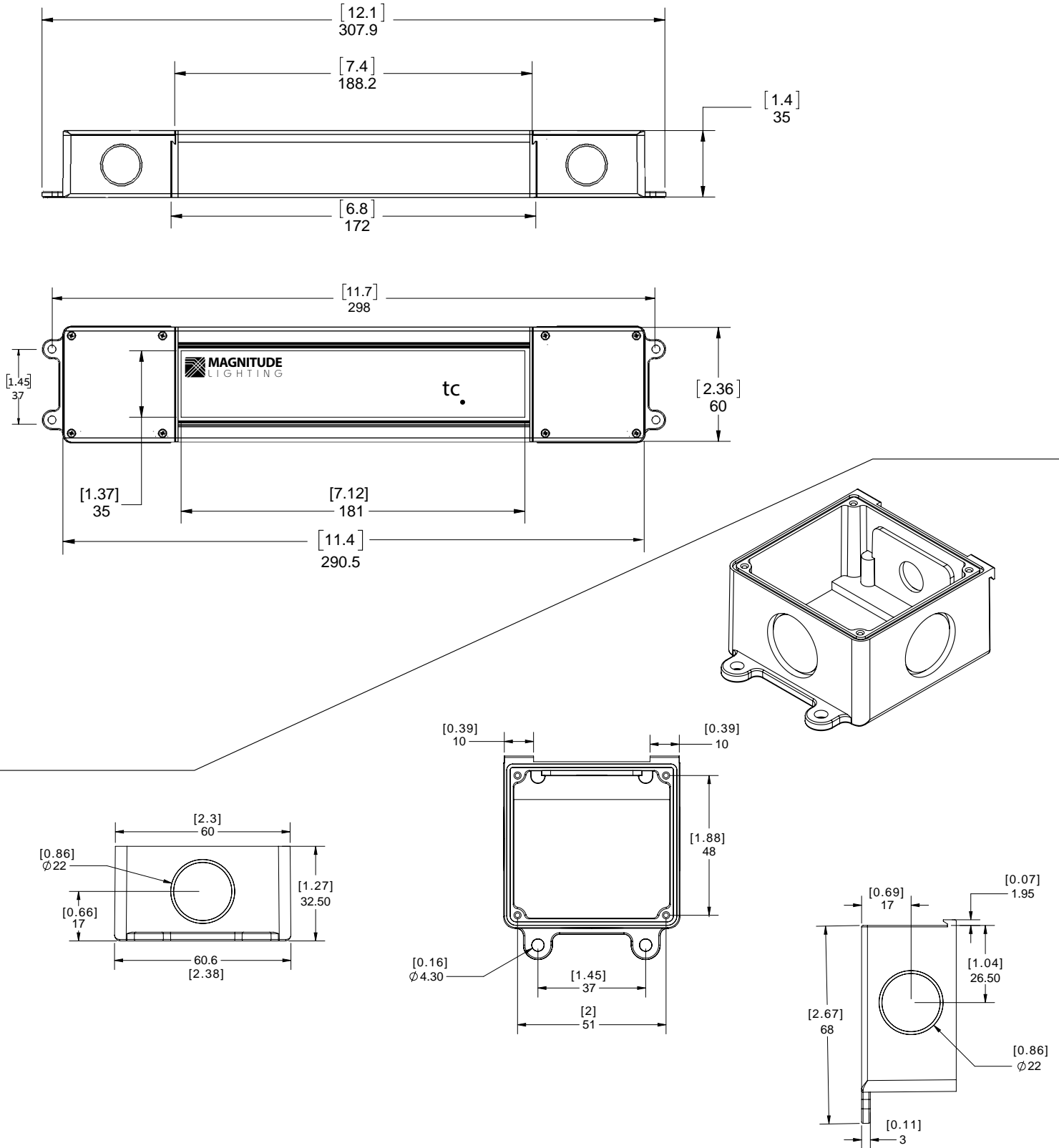

SOLIDRIVE

CONSTANT VOLTAGE 0-10V DIMMABLE LED DRIVER

MECHANICAL DIAGRAM CVD96R24DC - ENCLOSURE

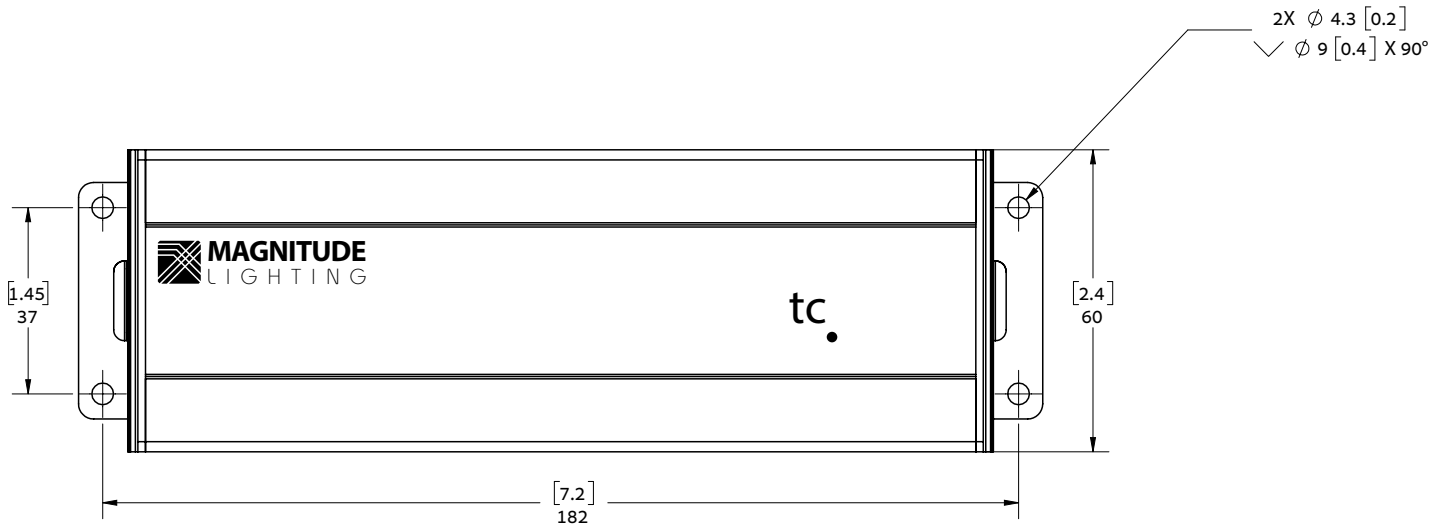
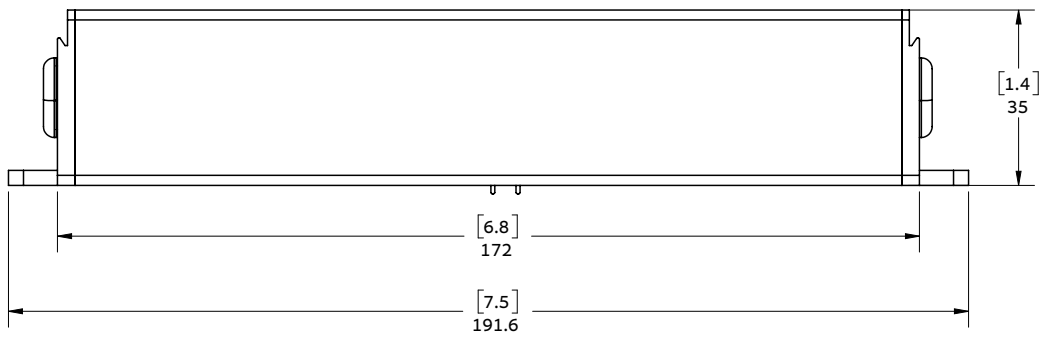
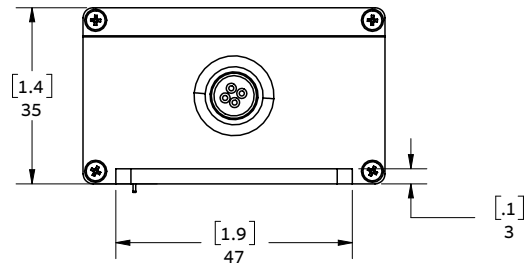

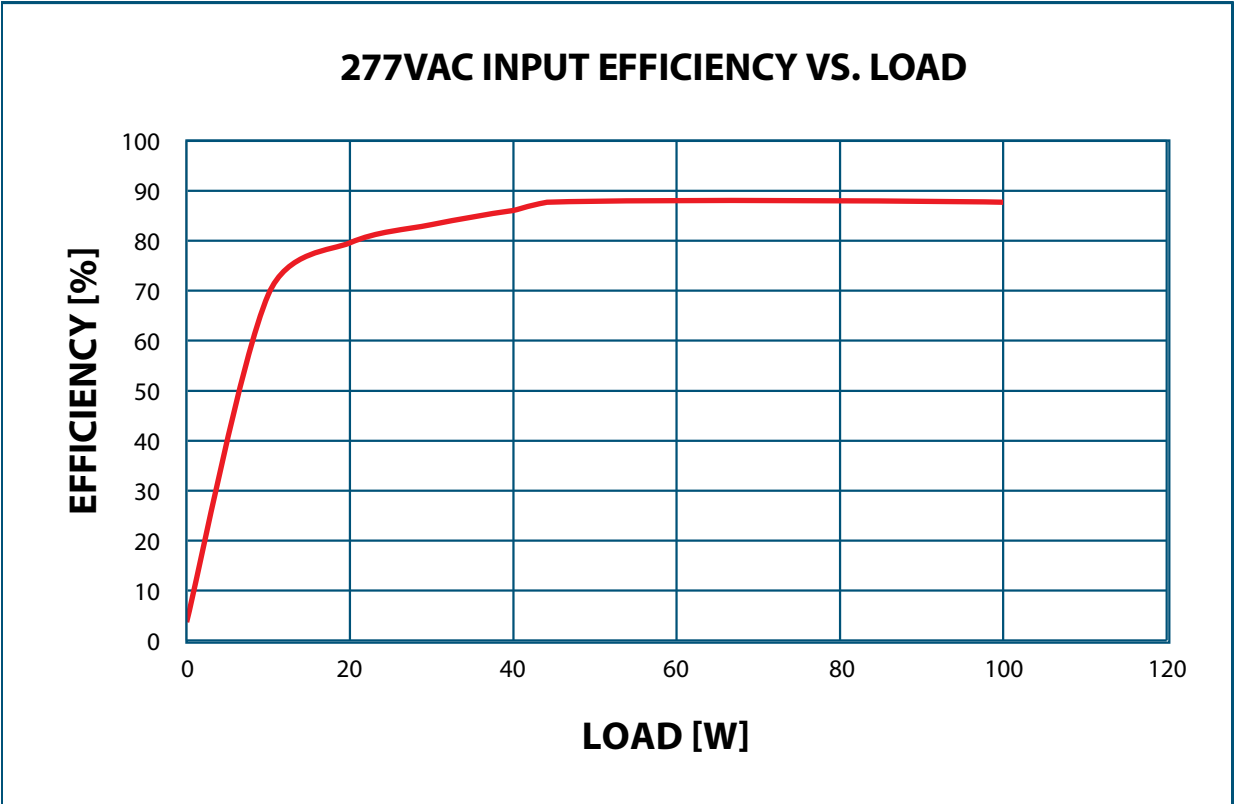
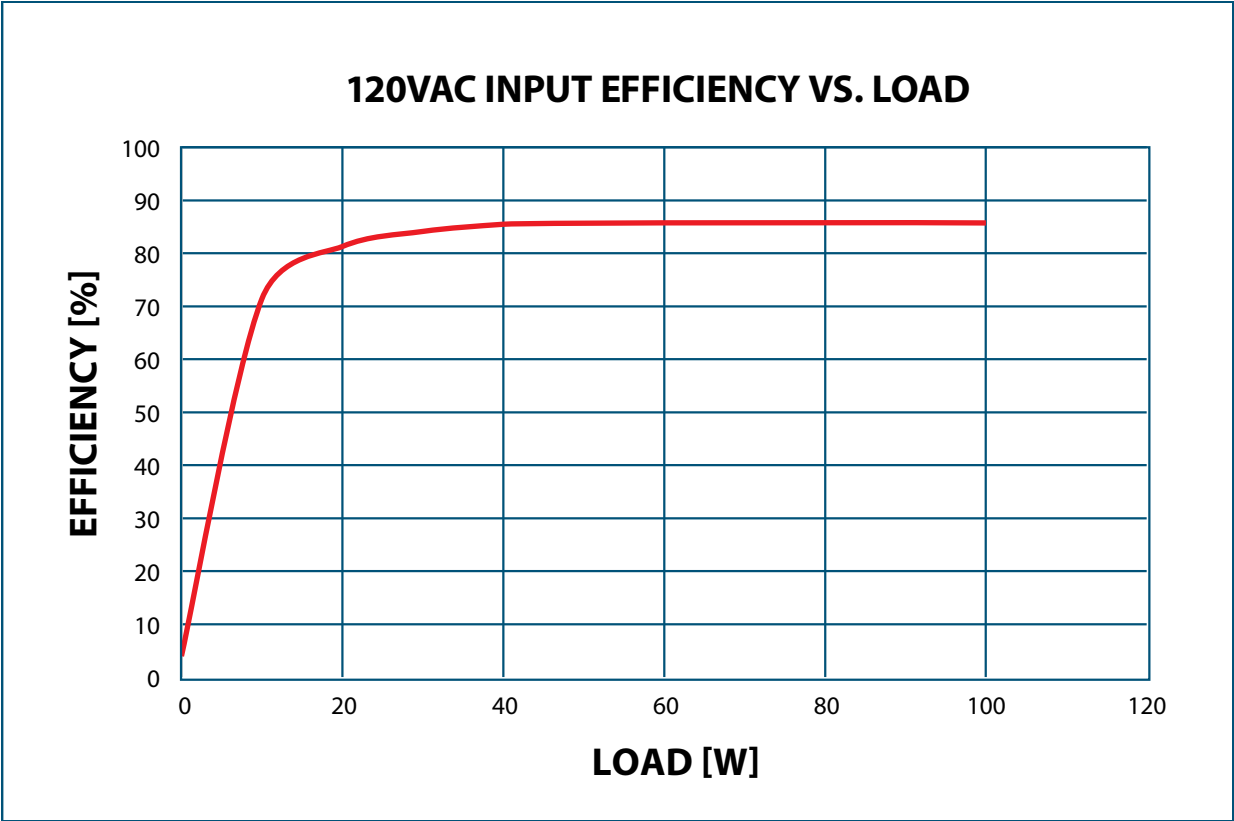

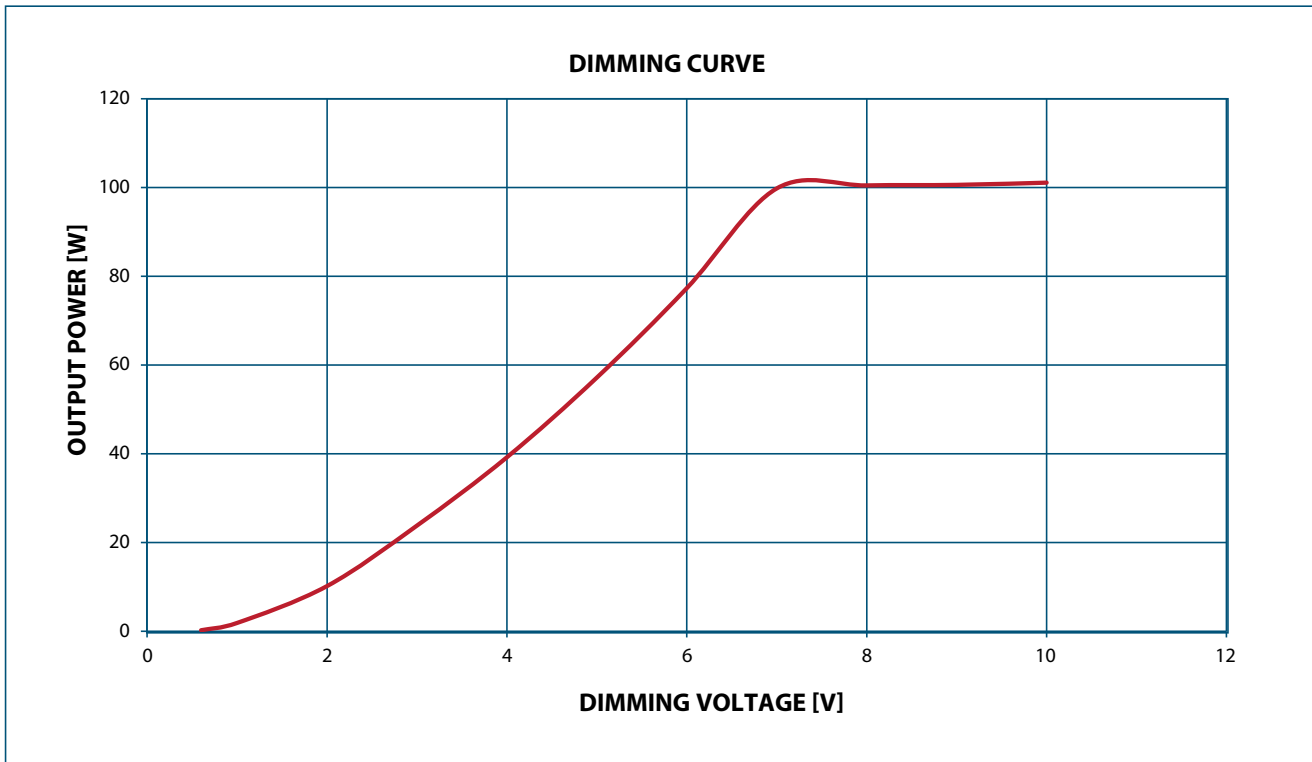

COMPATIBLE 0-10 DIMMER LIST

Dimming	Part Number
Lutron	Diva - DDTV
Lutron	Diva - NFTV
Lutron	Nova T - NTFTV
Leviton	illumatech - IP7
Watt Stopper	DCLV1
Lightolier Controls	ZP600FAM120
Phillips	Sunrise - SR1200ZTUNV