

UPHORIA™

LED MR-16

UPHORIA™ Series LED Lamps

Uphoria LED MR-16 lamps incorporate the highest quality Cree LED's, a customized optical design, and unsurpassed thermal management characteristics to provide outstanding efficiency, life, and quality. At 6.5 watts in a standard MR-16 form factor, Uphoria Series LED lamps incorporate a state of the art Cool-Blade™ heat sink design that guarantees reliability and stability through proper thermal management.

Uphoria's Cool-Blade™ technology was originally developed for the aerospace industry and the military and as a way of providing superior heat transfer for computer servers and intricate electronics that require premium thermal management in a very lightweight product. This same technology is incorporated into every Uphoria MR-16 lamp where individual, high-density aluminum cooling blades draw damaging heat away from the LED's creating an ideal operating environment for the chipsets. Less heat means a longer life for LED's and USHIO is proud to stand behind its high performance Uphoria lamps with a 3-year warranty and a rated life of 35,000 hours.

Rated at more than 10 times the life of standard halogen MR-16 lamps on the market today, Uphoria is the intelligent choice for those applications where frequency of lamp changes and cost of ownership are significant factors.

Uphoria LED MR-16 lamps are available in Narrow Flood (20 degree), Flood (35 degree) and Wide Flood (60 degree) beam spreads and in warm white (3000K) or daylight (5700K) color temperatures.



FEATURES & BENEFITS:

- 80% Energy Savings vs. Halogen MR-16
- Proprietary Cool-Blade™ Aluminum Heat Sink
- Proprietary Driver Designed for Optimal Thermal Management
- Very Tight Color Binning for Lamp to Lamp Consistency
- Long Life: 35,000 Hours
- Application Friendly: UV Free & IR Free
- Environmentally Friendly: Mercury Free, Lead Free & RoHS Compliant
- 3-Year Warranty

APPLICATIONS:

- Track Lighting
- Recessed Lighting
- Landscape Lighting
- Accent Lighting
- Art Gallery & Museum Lighting
- Display Case Lighting

Distributed by:



Scan with a smartphone
to view this product online.

© 2013 USHIO America, Inc. All rights reserved.

UPHORIA™ LED MR-16

Case Qty: 20

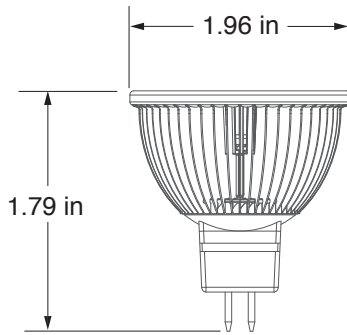

GU5.3 Base

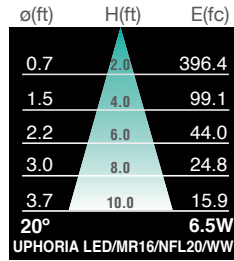

ITEM 1002483

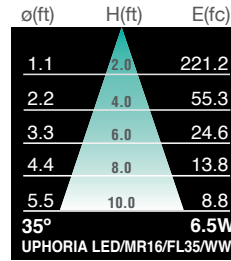

ITEM 1002484

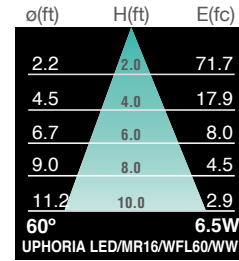

ITEM 1002485

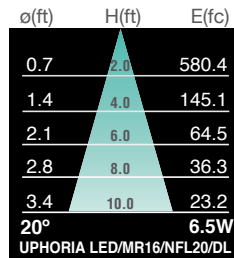

ITEM 1002486

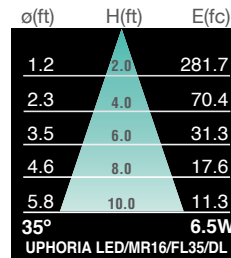

ITEM 1002487

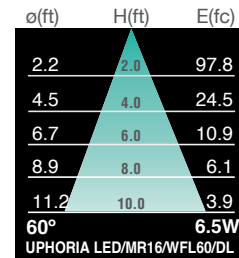

ITEM 1002488

Watts (W)	Ushio Ordering Code	Ushio Lamp Description	Volts (V)	Color Temp (K)	Beam Angle	Beam Spread	Lumens* (lm)	Max CP* (cd)	CRI	Avg** Life (h)
6.5	1002483	Uphoria LED MR16, NFL20, WW	12	3000	20	Narrow Flood	325	1586	80	35000
6.5	1002484	Uphoria LED MR16, FL35, WW	12	3000	35	Flood	350	885	80	35000
6.5	1002485	Uphoria LED MR16, WFL60, WW	12	3000	60	Wide Flood	335	300	80	35000
6.5	1002486	Uphoria LED MR16, NFL20, DL	12	5700	20	Narrow Flood	450	2321	70	35000
6.5	1002487	Uphoria LED MR16, FL35, DL	12	5700	35	Flood	485	1130	70	35000
6.5	1002488	Uphoria LED MR16, WFL60, DL	12	5700	60	Wide Flood	470	400	70	35000

* Photometric data is based on LM-79 tests performed at 12V AC.

** Average life based on 70% lumen maintenance. LM-80 data available.

Electrical Specifications:

Driver: High Efficiency

Operating Voltage Range: 8V to 17V AC or DC

Power Factor: >0.80

Dimming: Not designed for operation on dimming systems

Cautions:

Not for use in totally enclosed fixtures

Not designed for dimming systems

Suitable for dry and damp locations

Not for use in emergency or exit lighting

Qualifications:



UPHORIA™ LED MR-16

Polar & Spectral Distribution

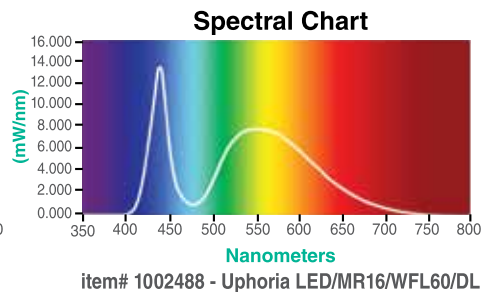
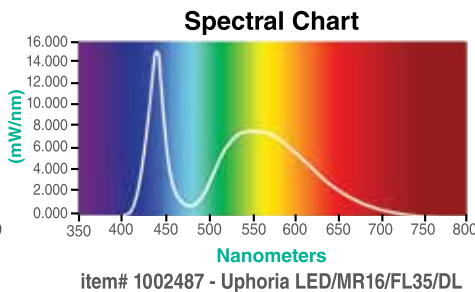
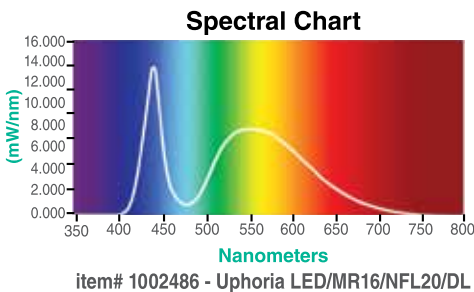
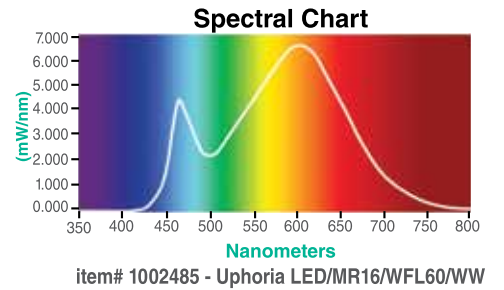
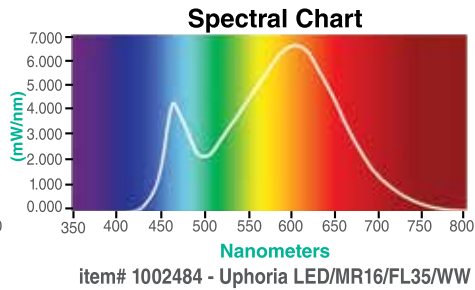
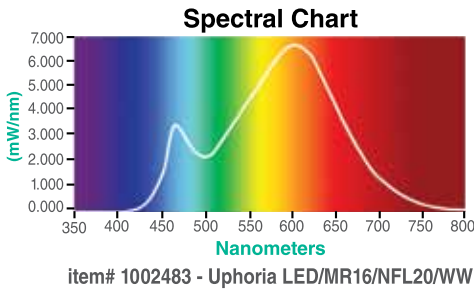
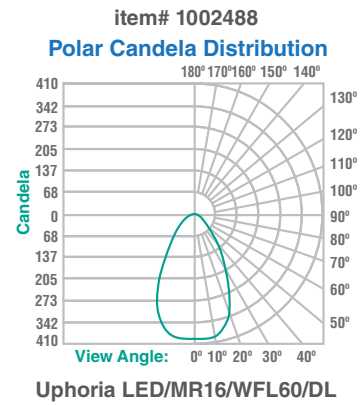
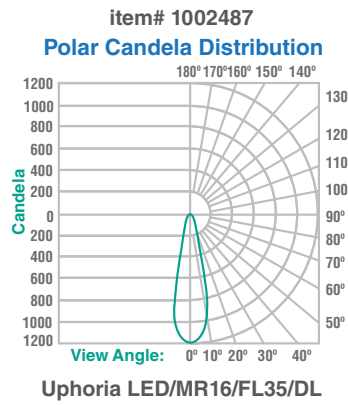
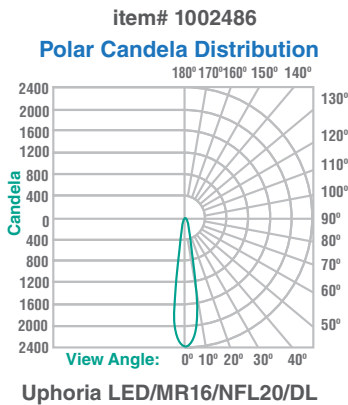
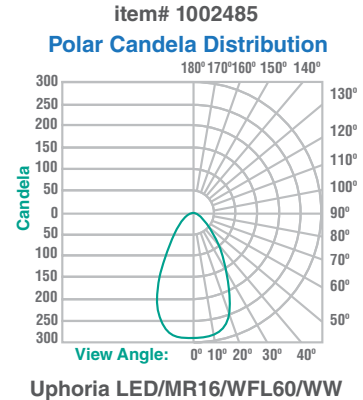
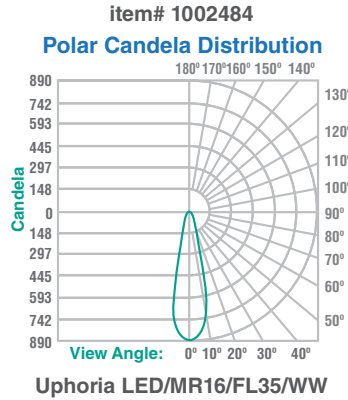
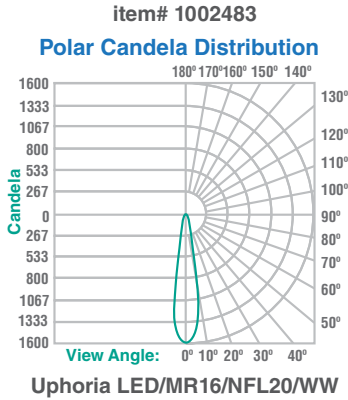

UPHORIA™ Series LED Lamps

Lighting Facts

item# 1002483
Uphoria LED/MR16/NFL20/WW

Lighting Facts/ Faits d'éclairage	
Per Bulb/Par l'ampoule	
Brightness/Luminosité	325 lumens
Estimated Yearly Energy Cost/ Coût énergétique annuel estimé	\$0.78
Based on 3 hrs/day, 11¢/kWh. Cost depends on rates and use. /Basé sur 3 heures/jour, 11¢/kWh. Les coûts dépendent du tarif et de la fréquence d'utilisation.	
Life/Vie	32 years/ans
Based on 3 hrs/day. /Basé sur 3 heures/jour.	
Light Appearance/Apparence de l'éclairage	
Warm/Chaud	Cool/Froid
3000K	
Energy Used/Énergie utilisée	6.5 watts

item# 1002484
Uphoria LED/MR16/FL35/WW

Lighting Facts/ Faits d'éclairage	
Per Bulb/Par l'ampoule	
Brightness/Luminosité	350 lumens
Estimated Yearly Energy Cost/ Coût énergétique annuel estimé	\$0.78
Based on 3 hrs/day, 11¢/kWh. Cost depends on rates and use. /Basé sur 3 heures/jour, 11¢/kWh. Les coûts dépendent du tarif et de la fréquence d'utilisation.	
Life/Vie	32 years/ans
Based on 3 hrs/day. /Basé sur 3 heures/jour.	
Light Appearance/Apparence de l'éclairage	
Warm/Chaud	Cool/Froid
3000K	
Energy Used/Énergie utilisée	6.5 watts

item# 1002485
Uphoria LED/MR16/WFL60/WW

Lighting Facts/ Faits d'éclairage	
Per Bulb/Par l'ampoule	
Brightness/Luminosité	335 lumens
Estimated Yearly Energy Cost/ Coût énergétique annuel estimé	\$0.78
Based on 3 hrs/day, 11¢/kWh. Cost depends on rates and use. /Basé sur 3 heures/jour, 11¢/kWh. Les coûts dépendent du tarif et de la fréquence d'utilisation.	
Life/Vie	32 years/ans
Based on 3 hrs/day. /Basé sur 3 heures/jour.	
Light Appearance/Apparence de l'éclairage	
Warm/Chaud	Cool/Froid
3000K	
Energy Used/Énergie utilisée	6.5 watts

item# 1002486
Uphoria LED/MR16/NFL20/DL

Lighting Facts/ Faits d'éclairage	
Per Bulb/Par l'ampoule	
Brightness/Luminosité	450 lumens
Estimated Yearly Energy Cost/ Coût énergétique annuel estimé	\$0.78
Based on 3 hrs/day, 11¢/kWh. Cost depends on rates and use. /Basé sur 3 heures/jour, 11¢/kWh. Les coûts dépendent du tarif et de la fréquence d'utilisation.	
Life/Vie	32 years/ans
Based on 3 hrs/day. /Basé sur 3 heures/jour.	
Light Appearance/Apparence de l'éclairage	
Warm/Chaud	Cool/Froid
5700K	
Energy Used/Énergie utilisée	6.5 watts

item# 1002487
Uphoria LED/MR16/FL35/DL

Lighting Facts/ Faits d'éclairage	
Per Bulb/Par l'ampoule	
Brightness/Luminosité	485 lumens
Estimated Yearly Energy Cost/ Coût énergétique annuel estimé	\$0.78
Based on 3 hrs/day, 11¢/kWh. Cost depends on rates and use. /Basé sur 3 heures/jour, 11¢/kWh. Les coûts dépendent du tarif et de la fréquence d'utilisation.	
Life/Vie	32 years/ans
Based on 3 hrs/day. /Basé sur 3 heures/jour.	
Light Appearance/Apparence de l'éclairage	
Warm/Chaud	Cool/Froid
5700K	
Energy Used/Énergie utilisée	6.5 watts

item# 1002488
Uphoria LED/MR16/WFL60/DL

Lighting Facts/ Faits d'éclairage	
Per Bulb/Par l'ampoule	
Brightness/Luminosité	470 lumens
Estimated Yearly Energy Cost/ Coût énergétique annuel estimé	\$0.78
Based on 3 hrs/day, 11¢/kWh. Cost depends on rates and use. /Basé sur 3 heures/jour, 11¢/kWh. Les coûts dépendent du tarif et de la fréquence d'utilisation.	
Life/Vie	32 years/ans
Based on 3 hrs/day. /Basé sur 3 heures/jour.	
Light Appearance/Apparence de l'éclairage	
Warm/Chaud	Cool/Froid
5700K	
Energy Used/Énergie utilisée	6.5 watts

Form No. S-UPH-0613

The specifications on this sheet supercede all previously published specifications and may be subject to change for design and specification improvement without prior notice.