

LED Corn Bulb Lamp Series



5 Years Warranty

Specifications

Model	PLT-3101
Rate Power	18W
Input Voltage	AC100-277V 50-60Hz
CCT	3000K
Power Factor	≥0.9
CRI	>80
Lumen	2027lm
Chips	Samsung
LED Quantity	56LEDs 0.3W
LED LM80	Yes



Samsung LM561B



Rubycon



E26



JAE Connector

Dimension

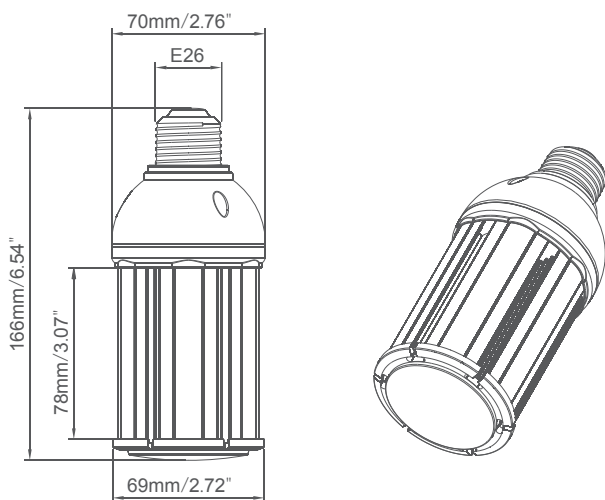

Luminous emittance

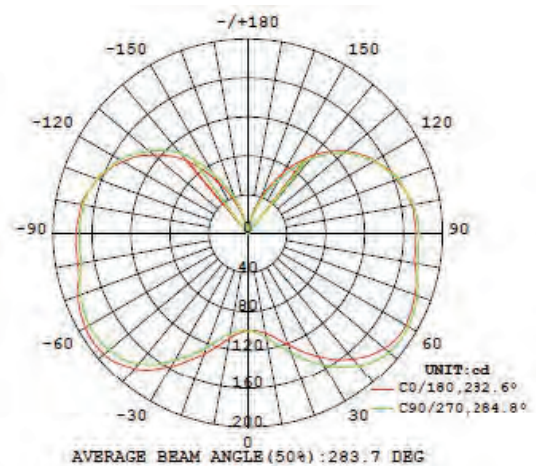

Long Lifespan of 10years

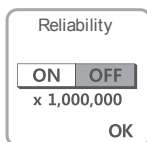

Reliability Test

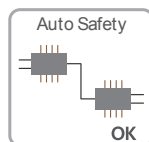

Safety Protection Circuit

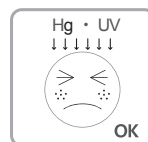

No Mercury No UVLight

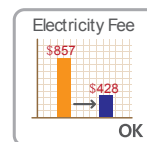

Big Saving(87%) on Electricity Costs

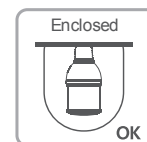

Usable in Enclosed Luminaires

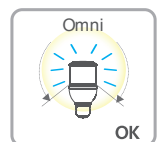

Omni Wide Angle

Installation



High bay lamp



Ceiling lamp

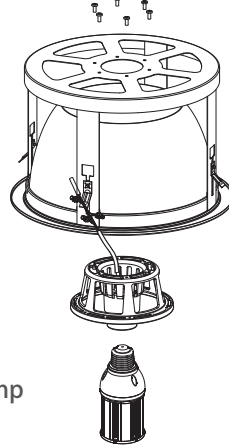

Garden lamp

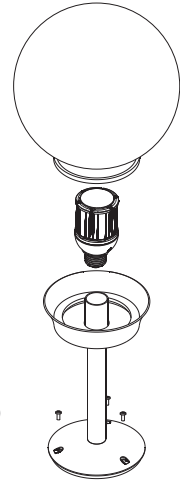

Absolute Maximum Rating

Parameter	Rating	Units
Aluminum Heat Sink Temperature	57	° C
Operating Temperature	-20~+65	° C
Storage Temperature	-40~+80	° C
Equilibrium Temperature	25	° C

Label

LED Corn Bulb lamp
Model:PLT-3101
AC100-277V 50-60Hz
Power:18W CCT:3000K

LED Corn Bulb lamp
Model:PLT-3101
AC100-277V 50-60Hz
Power:18W CCT:3000K

Product Packing Specification

Packing Details	
Pack Quantity	24pcs
Net Weight	0.76lbs/345g
Gross Weight Per CTN	22.04lbs/10kg
Box Size	83*83*195mm
CTN Size	350*265*410mm

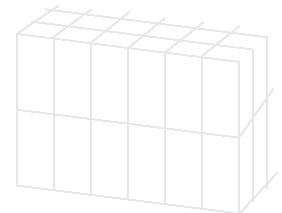
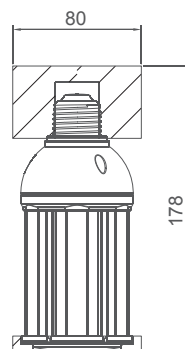

⚠ CAUTIONS

- Make sure remove the traditional ballast before replace the LED corn light.
- Don't take apart the product or replace mechanical and electronic components.
- Don't stare at the strong light for a long time as it may cause injury to eyes.