

UPHORIA™ EDGE LED MR16

LED MR16 Lamps

Ushio America introduces the ENERGY STAR® certified Uphoria™ Edge LED MR16 lamp family. Available in 5W and 6.5W models, these lamps offer an energy saving alternative for 35W to 50W halogen lamps with improved efficacy compared to their LED predecessors.

With the form, fit and function of traditional halogen MR16 lamps, these dimmable LEDs are lightweight with a smooth reflector design and provide 85-87% savings on energy costs. The Uphoria Edge series of premium LED MR16 lamps are damp location rated and are available in flood beam spreads.

Uphoria Edge LED MR16 lamps showcase two body designs that allow for improved efficacy and thermal management. The compact design of the 5W lamps allows for maximum heat dissipation while considering material efficiency. The 6.5W lamps feature a thermal design that allows air to flow through the inside and outside of the lamp and over the heat sink to maintain a proper temperature of the LEDs and achieve a reliable optimal output. These unique designs cool the lamps without the use of heat sink fins providing a sleek, modern look while still maintaining a quality light output and ensuring long life.

Ushio America is proud to stand behind these ENERGY STAR certified LED lamps with a 3-year limited warranty.

All Uphoria Edge LED MR16 lamps operate on 12V in either a Soft White (2700K) or a Warm White (3000K) color temperature.



FEATURES & BENEFITS:

- Energy Saving
- Dimmable
- Direct Replacement for Halogen MR16 Lamps
- Damp Location Rated
- 25,000 Hours Rated Life
- Application Friendly: UV Free & IR Free
- Environmentally Friendly: Mercury Free, Lead Free & RoHS Compliant
- 3-Year Limited Warranty

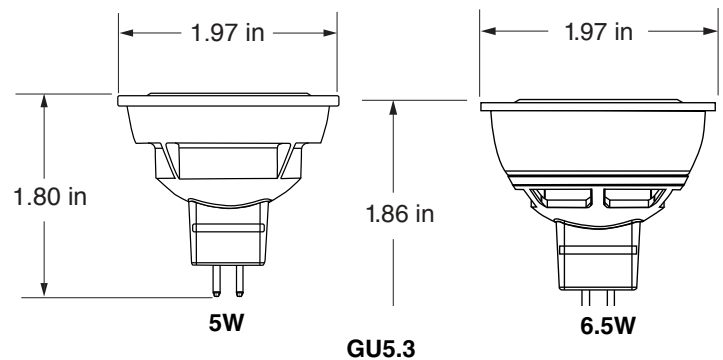

APPLICATIONS:

- Track Lighting
- Recessed Lighting
- Landscape Lighting
- Accent Lighting
- Art Gallery & Museum Lighting
- Hospitality Lighting

Qualifications:



USHIO

UPHORIA™ EDGE LED MR16

Watts (W)	Ordering Code	Lamp Description	Volts (V)	Color Temp (K)	Beam Angle	Beam Spread	Lumens* (lm)	CBCP* (cd)	CRI	Rated** Life (h)	Case Qty
5	1004142	★ UPHORIA EDGE LED MR16, FL35, SW27	12	2700	35°	Flood	350	963	80+	25,000	24
5	1004143	★ UPHORIA EDGE LED MR16, FL35, WW30	12	3000	35°	Flood	350	983	80+	25,000	24
6.5	1004144	★ UPHORIA EDGE LED MR16, FL35, SW27	12	2700	35°	Flood	500	1323	80+	25,000	24
6.5	1004145	★ UPHORIA EDGE LED MR16, FL35, WW30	12	3000	35°	Flood	500	1302	80+	25,000	24

* Photometric data is based on LM-79 tests.

** Hours rated life based on 70% lumen maintenance. LM-80 data available.

★ ENERGY STAR Certified

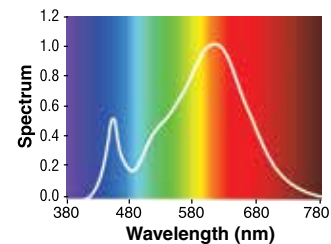
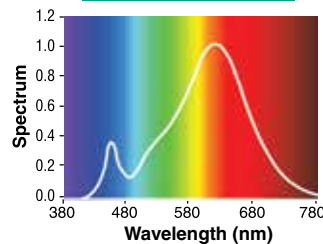
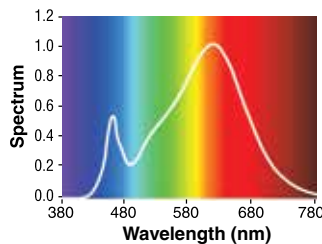
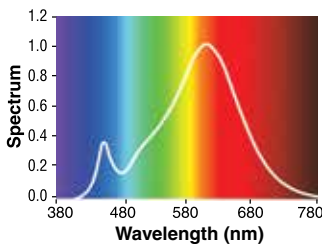
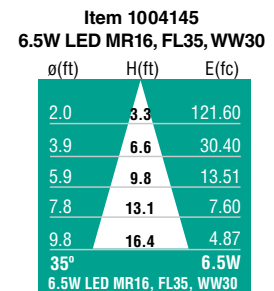
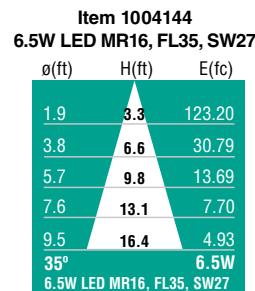
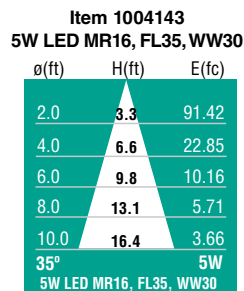
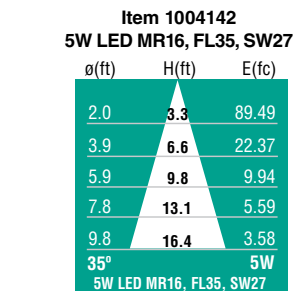

**Lighting Facts/
Faits d'éclairage**

Per Bulb/Par l'ampoule

Brightness/Luminosité 350 lumens

**Estimated Yearly Energy Cost/
Coût énergétique annuel estimé** \$0.60

Based on 3 hrs/day, 11¢/kWh. Cost depends on rates and use. /Basé sur 3 heures/jour, 11¢/kWh. Les coûts dépendent du tarif et de la fréquence d'utilisation.

Life/Vie 22.8 years/ans
Based on 3 hrs/day. /Basé sur 3 heures/jour.

Light Appearance/Apparence de l'éclairage

Warm/Chaud ————— Cool/Froid

2700K

Energy Used/Énergie utilisée 5 watts

**Lighting Facts/
Faits d'éclairage**

Per Bulb/Par l'ampoule

Brightness/Luminosité 350 lumens

**Estimated Yearly Energy Cost/
Coût énergétique annuel estimé** \$0.60

Based on 3 hrs/day, 11¢/kWh. Cost depends on rates and use. /Basé sur 3 heures/jour, 11¢/kWh. Les coûts dépendent du tarif et de la fréquence d'utilisation.

Life/Vie 22.8 years/ans
Based on 3 hrs/day. /Basé sur 3 heures/jour.

Light Appearance/Apparence de l'éclairage

Warm/Chaud ————— Cool/Froid

3000K

Energy Used/Énergie utilisée 5 watts

**Lighting Facts/
Faits d'éclairage**

Per Bulb/Par l'ampoule

Brightness/Luminosité 500 lumens

**Estimated Yearly Energy Cost/
Coût énergétique annuel estimé** \$0.78

Based on 3 hrs/day, 11¢/kWh. Cost depends on rates and use. /Basé sur 3 heures/jour, 11¢/kWh. Les coûts dépendent du tarif et de la fréquence d'utilisation.

Life/Vie 22.8 years/ans
Based on 3 hrs/day. /Basé sur 3 heures/jour.

Light Appearance/Apparence de l'éclairage

Warm/Chaud ————— Cool/Froid

2700K

Energy Used/Énergie utilisée 6.5 watts

**Lighting Facts/
Faits d'éclairage**

Per Bulb/Par l'ampoule

Brightness/Luminosité 500 lumens

**Estimated Yearly Energy Cost/
Coût énergétique annuel estimé** \$0.78

Based on 3 hrs/day, 11¢/kWh. Cost depends on rates and use. /Basé sur 3 heures/jour, 11¢/kWh. Les coûts dépendent du tarif et de la fréquence d'utilisation.

Life/Vie 22.8 years/ans
Based on 3 hrs/day. /Basé sur 3 heures/jour.

Light Appearance/Apparence de l'éclairage

Warm/Chaud ————— Cool/Froid

3000K

Energy Used/Énergie utilisée 6.5 watts

Electrical Specifications:

Driver: High Efficiency

Power Factor: > 0.70

Dimming: See website for dimmer compatibility options.

CAUTIONS:

Not for use in totally enclosed fixtures.

Suitable for dry and damp locations.

Not for use in emergency or exit lighting.

CAUTIONS:

The lamp may not be compatible with all dimmers and transformers. Check website to find up to date dimmer and transformer compatibility options. Use only 12V 60Hz circuits. Do not open. No user serviceable parts inside. Suitable for damp locations. Use is not recommended where exposed to weather. Outdoor usage requires an enclosed fixture. The device is not intended for use with emergency exit fixtures, emergency exit lights, photo controls or electric timers. Enclosed or recessed fixtures must contain proper ventilation. Reliable Operating temperature is -4° F to 113° F. This device complies with Part 15 of the FCC Rules. Operation is subject to the following two conditions: (1) this device may not cause harmful interference, and (2) this device must accept any interference received, including interference that may cause undesired operation.

USHIO

Form No. S-UPHEDGEMR16/1116
Specifications may be subject to change without prior notice.