

LUNERA CFL LED UNIVERSAL MOUNT

LED Replacement for 4-pin G24Q Compact Fluorescent Lamps
Type B – Ballast Bypassed

Installation Description

The **LUNERA CFL LED G24Q UNIVERSAL MOUNT** is a line driven (Type B, ballast bypassed) LED replacement for CFL lamps with a 4-pin G24q base. The lamp replaces 13W ~ 42W CFLs and is available in 3 lumen outputs (1,200lm, 2,300lm, and 3,500lm) and 4 color temperatures (2700K, 3000K, 3500K, and 4000K CCT).

This lamp has a built-in driver that allows operation at 120V ~ 277V. It is NOT compatible with ballast or LED drivers and the fixture socket must be wired to AC line voltage.

The lamp is intended for open or lensed recessed downlights with a single G24q socket in a vertical mounted orientation or a single or double G24q socket configuration in a horizontal mounted orientation.

Always turn OFF power to the fixture before removing existing lamps, bypassing the ballast, inspecting the socket, and installing this lamp.

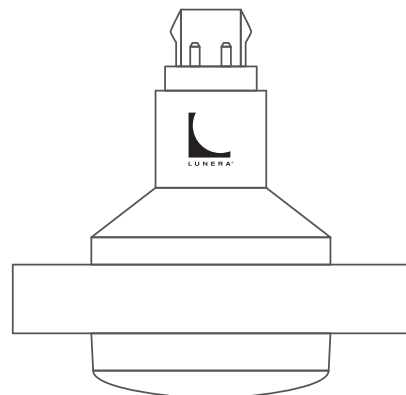

Lamp with 4-pin G24q-1/
-2 /-3 Compatible Base

Product SKUs

Verify the product SKU before installing the lamp. Product SKUs on the lamp must match one of the following SKUs.

Product SKU	Max Lumens	Avg. Lamp Power	Base Type
HN-PLVH-G24Q-L-10W-8yy	1,200lm	10W	4-pin G24q
HN-PLVH-G24Q-L-20W-8yy	2,300lm	20W	4-pin G24q
HN-PLVH-G24Q-L-30W-8yy	3,000lm	30W	4-pin G24q

yy=CCT: 27=2700K; 30=3000K; 35=3500K; 40=4000K

Fixture Compatibility

This lamp fits in fixtures that are configured with G24q 4-pin sockets.

The fixture aperture must be greater than 4.25 inches internal diameter and the fixture's lamp compartment must be at least 4 inches in depth. Check that the intended fixture depth is sufficient to contain the lamp.

The lamp ships with a vertical extension accessory that lowers the lamp approximately 2 inches in very deep lamp compartments and a horizontal-to-vertical adapter that orients the lamp lens vertically in fixtures with horizontal sockets and allow for centering of the lamp visually within the fixture aperture

The fixture may be open or lensed (sealed).







Installation Instructions

Before beginning installation, verify that the LUNERA CFL LED G24Q UNIVERSAL MOUNT is an appropriate LED lamp replacement for your fixture.

Lamp Replacement Compatibility

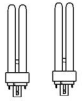
The LUNERA CFL LED G24Q UNIVERSAL MOUNT is a line driven (ballast bypassed) LED replacement for the following types of ballast driven CFLs with a 4-pin G24q-1/-2/3 base:

Lunera CFL LED G24q	Replaces G24q Base CFL Lamps with Wattages* / Delivered Lumen (up to)		
	Horizontal		Vertical
LED Type B (Line Driven) 	1 CFL Lamp 	2 CFL Lamps 	1 CFL Lamp 
10W* 1,200lm	18W* 800lm	13W (x2) 1,200lm	18W 800lm
20W 2,300lm	42W 1,600lm	26W (x2) 2,000lm	42W 1,600lm
30W 3,500lm	—	42W (x2) 2,900lm	—

* To determine energy savings, use system wattage:

For LED, lamp wattage = system wattage.

For CFL, wattage shown is lamp wattage only. Add apx. 10% to CFL lamp wattage.

Installation Instructions -- Line Driven Ballast Bypassed

Prepare the Fixture for Retrofit

1. Turn power OFF to the fixture.
2. Remove the existing lamp, allowing sufficient time for the lamp to first cool. Verify that it is a 4-pin G24q base CFL.
3. Measure the fixture aperture and lamp compartment to ensure there is sufficient clearance for the lamp once installed.
4. Inspect the socket to ensure it is in good working order, free of rust, corrosion, or wear.
5. Remove the fixture trim/reflector from the fixture housing.

Installation Instructions -- Line Driven Ballast Bypassed, continued

Vertically Oriented Socket, Single-Lamp

Modify the Fixture

6. Remove the inner junction box cover and disconnect the ballast from input wiring and lampholder leads.
7. Dispose of the removed ballast and lamp in accordance with local government regulations.
8. Connect input wiring to the lampholder leads according to the diagrams below.

Single Lamp Retrofit Ballast Bypassed Wiring

BEFORE

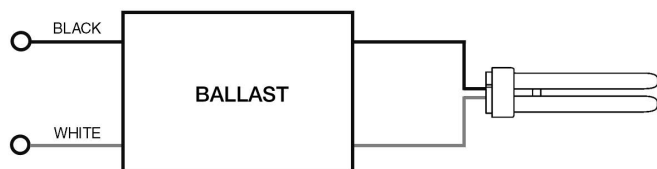

AFTER

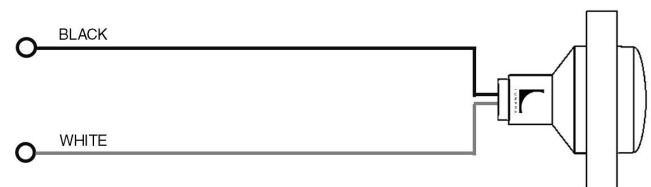

9. Place wires and connection back into the wiring box and replace the inner junction box cover.
10. Reinstall the trim/reflector in the fixture housing.
11. Apply the included re-lamping label on a visible location inside the fixture.

Complete the Retrofit

12. If the distance from the lamp lens to the fixture aperture opening is acceptable, insert the lamp firmly into the G24q socket.
13. If the distance from the lamp lens to the fixture aperture opening is too great (lamp is seated too high in the lamp compartment), insert the lamp firmly into the G24q vertical lamp extender accessory, and then seat the extended lamp into the fixture socket. This will lower the lamp approximately 2" in the compartment.

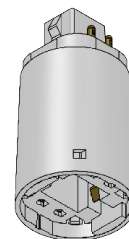

UPON COMPLETION OF THE RETROFIT, IF THE LAMP OR LUMINAIRE EXHIBITS UNDESIRABLE OPERATION (BUZZING, FLICKERING, STROBING, ETC.), IMMEDIATELY TURN OFF POWER, REMOVE LAMP FROM LUMINAIRE, AND CONTACT LUNERA.

Installation Instructions -- Line Driven Ballast Bypassed, continued

Horizontally Oriented Socket, Single-Lamp

Modify the Fixture

6. Remove the inner junction box cover and disconnect the ballast from input wiring and lampholder leads.
7. Dispose of the removed ballast and lamp in accordance with local government regulations.
8. Connect input wiring to the lampholder leads according to the diagrams below.

Single Lamp Retrofit Ballast Bypassed Wiring

BEFORE

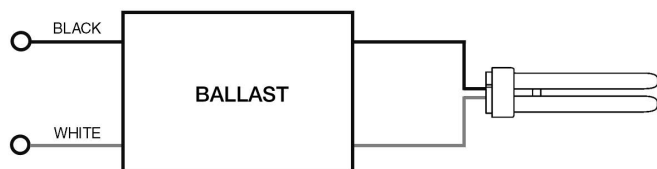

AFTER

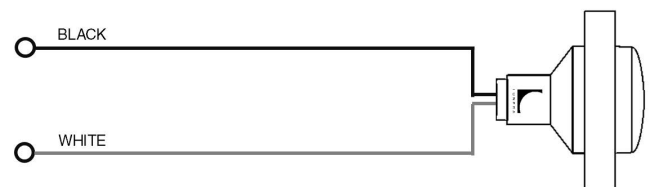

9. Place wires and connection back into the wiring box and replace the inner junction box cover.
10. Reinstall the trim/reflector in the fixture housing.
11. Apply the included re-lamping label on a visible location inside the fixture.

Complete the Retrofit

12. Insert the lamp into the female G24q socket of the Articulated Telescoping Horizontal Extender, ensuring it is firmly seated. Push the telescoping arm to ensure it is fully retracted.
13. Align the male G24q base of the accessory with the horizontal G24q socket of the fixture, ensuring that the lamp lens is facing down and firmly seat the lamp/accessory into the socket.
14. The accessory allows for the arm to be extended (telescoping) and articulated (articulated) to center the lamp in a vertical orientation in the fixture compartment.

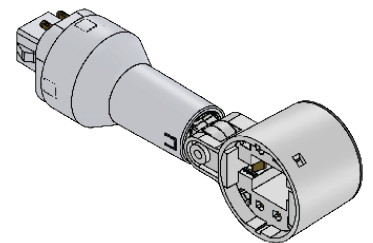

UPON COMPLETION OF THE RETROFIT, IF THE LAMP OR LUMINAIRE EXHIBITS UNDESIRABLE OPERATION (BUZZING, FLICKERING, STROBING, ETC.), IMMEDIATELY TURN OFF POWER, REMOVE LAMP FROM LUMINAIRE, AND CONTACT LUNERA.

Installation Instructions -- Line Driven Ballast Bypassed, continued

Horizontally Oriented Sockets, Dual-Lamp

Modify the Fixture

6. Remove the inner junction box cover and disconnect the ballast from input wiring and lampholder leads.
7. Dispose of the removed ballast and lamps in accordance with local government regulations.
8. Connect input wiring to the lampholder leads according to the diagrams below.

BEFORE

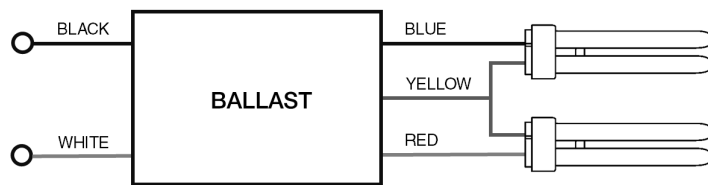

AFTER

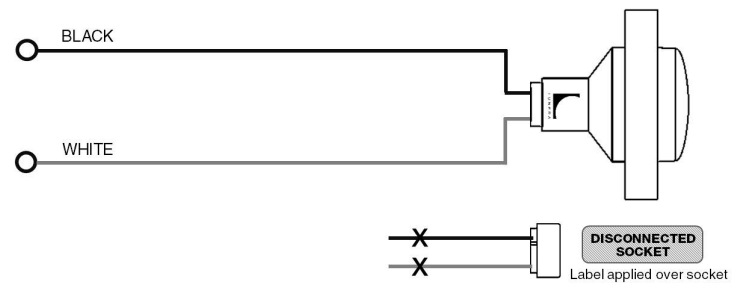

9. Disconnect one of the sockets and place the installation tape over the socket identifying it as a disconnected socket.
10. Place wires and connection back into the wiring box and replace the inner junction box cover.
11. Reinstall the trim/reflector in the fixture housing.
12. Apply the included re-lamping label on a visible location inside the fixture.

Complete the Retrofit



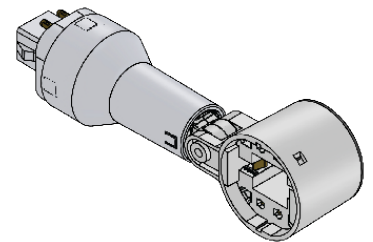





13. Insert the lamp into the female G24q socket of the Articulated Telescoping Horizontal Extender, ensuring it is firmly seated. Push the telescoping arm to ensure it is fully retracted.
14. Align the male G24q base of the accessory with the horizontal G24q socket of the fixture, ensuring that the lamp lens is facing down and firmly seat the lamp/accessory into the socket.
15. The accessory allows for the arm to be extended (telescoping) and articulated (articulated) to center the lamp in a vertical orientation in the fixture compartment.

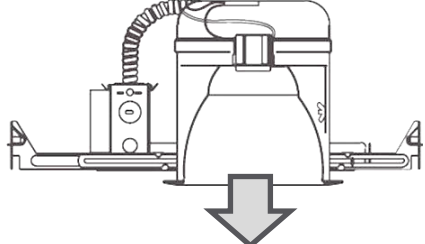

UPON COMPLETION OF THE RETROFIT, IF THE LAMP OR LUMINAIRE EXHIBITS UNDESIRABLE OPERATION (BUZZING, FLICKERING, STROBING, ETC.), IMMEDIATELY TURN OFF POWER, REMOVE LAMP FROM LUMINAIRE, AND CONTACT LUNERA.

COMPATIBLE Applications

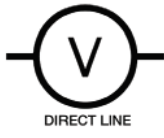
The LUNERA CFL LED G24Q UNIVERSAL MOUNT is designed for common commercial fixtures with a single or dual 4-pin G24q sockets on CFL lamps that meet the following characteristics.

Lamps Types Replaced	Socket	Mounting	Fixture Types
CFL 13W ~ 42W 	Q24q -1/-2/-3    G24q-1 G24q-2 G24q-3	Vertical (direct or with the horizontal-to-vertical accessory) 	Recessed Downlights Non-lensed or Lensed 
Power Sources		Controls	
120V ~ 277V AC Direct Line Voltage 		Non-dimming (rocker) switch 	

INCOMPATIBLE Applications

Applications with the following characteristics are **INCOMPATIBLE** with the LUNERA CFL LED G24Q UNIVERSAL MOUNT. Installation of this lamp in such applications may result in lamp failure or fixture malfunction. Product Warranty will be voided if the lamp is installed into the following applications.

Lamps Types Replaced	Socket	Mounting	Controls	Power Sources
<ul style="list-style-type: none"> Any other lamp except a CFL 13W ~ 42W with a 4-pin G24q base 	<ul style="list-style-type: none"> Any 4-pin CFL G24q socket except a G24q-1/-2/-3 	<ul style="list-style-type: none"> Horizontal (final lens orientation) 	<ul style="list-style-type: none"> Dimming controls 	<ul style="list-style-type: none"> Ballasts LED Drivers AC Line Voltage <108V or >305V

General Safety Information

READ AND FOLLOW ALL SAFETY INSTRUCTIONS

DANGER – RISK OF FIRE OR ELECTRIC SHOCK. LED RETROFIT KIT INSTALLATION REQUIRES KNOWLEDGE OF LUMINAIRES ELECTRICAL SYSTEM. IF NOT QUALIFIED, DO NOT ATTEMPT INSTALLATION. CONTACT A QUALIFIED ELECTRICIAN.

RISQUE D'INCENDIE OU D'ÉLECTROCUTION. L'INSTALLATION DE CE KIT DE CONVERSION NÉCESSITE LA CONNAISSANCE DU SYSTÈME ÉLECTRIQUE DU LUMINAIRE. SI NON QUALIFIÉ, NE PAS ESSAYER D'INSTALLER ET CONTACTER UN ÉLECTRICIEN QUALIFIÉ.

DANGER – RISK OF FIRE OR ELECTRIC SHOCK. INSTALL THIS KIT ONLY IN LUMINAIRES THAT HAVE THE CONSTRUCTION FEATURES AND DIMENSIONS SHOWN IN PRODUCT SPECIFICATION SHEET AND/OR DRAWINGS AND WHERE THE INPUT RATING OF THE LAMP DOES NOT EXCEED THE INPUT RATING OF THE LUMINAIRE.

RISQUE D'INCENDIE OU D'ÉLECTROCUTION. N'INSTALLER CE KIT QUE DANS DES LUMINAIRES AYANT LA CONSTRUCTION ET LES DIMENSIONS INDIQUÉES DANS LA FICHE TECHNIQUE ET SI LES VALEURS DE COURANT ET PUISSANCE À L'ENTRÉE DU KIT N'EXCÈDENT PAS CELLES DU LUMINAIRE.

WARNING – DO NOT MAKE OR ALTER ANY OPEN HOLES IN AN ENCLOSURE OF WIRING OR ELECTRICAL COMPONENTS DURING KIT INSTALLATION.

NE PAS PERCER OU MODIFIER DE TROU EXISTANTS DANS UN COMPARTIMENT CONTENANT DES FILS OU DES COMPOSANTS ÉLECTRIQUES DURANT L'INSTALLATION DU KIT.

WARNING – THIS LAMP IS NOT INTENDED FOR USE WITH ANY BALLAST OR EXTERNAL LED DRIVER. LAMP INSTALLATION WITH EXTERNAL DRIVER OR HID BALLAST VOIDS THE PRODUCT WARRANTY.

CETTE LAMPE N'EST PAS CONÇUE POUR ÊTRE UTILISÉE AVEC UN BALLAST LED OU BALLAST POUR LAMPES À DÉCHARGE. L'INSTALLATION DE CETTE LAMPE AVEC UN BALLAST LED OU UN BALLAST POUR LAMPES À DÉCHARGE ANNULE LA GARANTIE DU PRODUIT.

WARNING – IF THE LAMP OR LUMINAIRE EXHIBITS UNDESIRABLE OPERATION (BUZZING, FLICKERING, ETC) IMMEDIATELY TURN OFF POWER, REMOVE LAMP FROM LUMINAIRE AND CONTACT MANUFACTURER.

SI LA LAMPE OU LUMINAIRE MONTRE DES SIGNES D'OPERATION INDESIRABLES (BRUIT, VIBRATION, CLIGNOTEMENT, ETC) COUPER LE COURANT IMMEDIATEMENT, ENLEVER LA LAMPE DU LUMINAIRE ET CONTACTER LE FABRIQUANT.

WARNING – TO PREVENT WIRING DAMAGE OR ABRASION, DO NOT EXPOSE WIRING TO EDGES OF SHEET METAL OR OTHER SHARP OBJECTS.

POUR ÉVITER L'ENDOMMAGEMENT OU L'ABRASION DES FILS, NE PAS EXPOSER LES FILS AUX BORDS DES PIÈCES DE TÔLERIE OU AUTRES PIÈCES TRANCHANTES.

General Safety Information, continued

CAUTION – DO NOT INSTALL THIS LAMP TO LINE VOLTAGE ABOVE 277VAC. THIS LAMP SUPPORTS 120VAC-277VAC VOLTAGE RANGE. DO NOT INSTALL THIS LAMP WITH DIMMERS. LAMP INSTALLATION WITH LINE VOLTAGE ABOVE 277V VOIDS THE WARRANTY.

NE PAS INSTALLER CETTE LAMPE SUR UNE TENSION DE SECTEUR SUPÉRIEURE À 277VAC. CETTE LAMPE EST CONÇUE POUR UNE GAMME DE TENSION ENTRE 120VAC ET 277VAC. NE PAS BRANCHER CETTE LAMPE SUR UN ATTÉNUATEUR.

CAUTION – LAMP INSTALLATION WITH LINE VOLTAGE ABOVE 277V VOIDS THE WARRANTY.

L'INSTALLATION DE CETTE LAMPE SUR UNE TENSION DE SECTEUR SUPÉRIEURE À 277V ANNULE LA GARANTIE.

NOTES

* This lamp complies with FCC Parts15A/B. Operation is subject to the following conditions:

- (1) this device may not cause harmful interference, and
- (2) this device must accept any interference received, including interference that may cause undesired operations.