

**P3010H – Photoelectric Smoke Alarm w/ Safety Light**  
**P3010B – Photoelectric Smoke Alarm w/ Voice Alarm**  
**P3010L – Photoelectric Smoke Alarm**

## Smoke Alarm User Guide

Thank you for purchasing this Kidde Smoke Alarm. These models are battery operated Smoke Alarms which feature a non-replaceable, sealed-in battery and SMART HUSH™ Control to temporarily silence nuisance alarms.

**Important:** Please take a few minutes to thoroughly read this user guide which should be saved for future reference and passed on to any subsequent owner.

Teach children how to respond to the alarm and that they should never play with the unit.

Your Kidde Smoke Alarm was designed specifically for use in a residential environment. It is not designed for use in a recreational vehicle (RV) or boat.

**For your convenience, write down the following information. If you call Product Support, these are the first questions you will be asked.**

<b>Smoke Alarm Model Number:</b> (located on back of alarm)	
<b>Date Code:</b> (located on back of alarm) The National Fire Protection Association (NFPA) and the manufacturer recommend replacing this alarm ten years from the date code.	
<b>Date of Purchase:</b>	
<b>Where Purchased:</b>	

**SIGNALING**



P/N: 0311-7201-02 RevA

# WHAT TO DO WHEN THE ALARM SOUNDS

## SMOKE ALARM ACTIVATION

**Smoke alarm pattern is three long beeps repeating.**

- Alert small children in the home as well as anyone else that might have difficulty recognizing the importance of the alarm sounding or that might have difficulty leaving the area without help.
- Leave immediately by your escape plan. Every second counts, so don't waste time getting dressed or picking up valuables.
- In leaving, don't open any inside door without first feeling its surface. If hot, or if you see smoke seeping through cracks, don't open that door! Instead, use your alternate exit. If the inside of the door is cool, place your shoulder against it, open it slightly and be ready to slam it shut if heat and smoke rush in.
- Stay close to the floor if the air is smoky. Breathe shallowly through a cloth, wet if possible.
- Once outside, go to your selected meeting place and make sure everyone is there.
- Call the fire department from your neighbor's home - not from yours!
- Don't return to your home until the fire officials say that it is all right to do so.
- There are situations where a smoke alarm may not be effective to protect against fire as stated in the NFPA Standard 72. For instance:
  - a) smoking in bed
  - b) leaving children home alone
  - c) cleaning with flammable liquids, such as gasoline
- If the escape route requires you to go through smoke, crawl low under the smoke where the air is clearer.

## CONTENTS OF THIS USER GUIDE

- 1 — LIMITATIONS OF SMOKE ALARMS
- 2 — RECOMMENDED LOCATIONS FOR ALARMS
- 3 — LOCATIONS TO AVOID
- 4 — INSTALLATION / MOUNTING INSTRUCTIONS
- 5 — OPERATION AND TESTING
- 6 — VISUAL AND AUDIBLE INDICATIONS
- 7 — NUISANCE AND HUSH
- 8 — BATTERY
- 9 — DEACTIVATION OF ALARM
- 10 — CLEANING
- 11 — GOOD SAFETY HABITS
- 12 — SERVICE AND WARRANTY

This alarm detects products of combustion using photoelectric technology.

This alarm is acceptable for use in all residential applications where smoke alarms are required.

After ten (10) years of cumulative power up, this unit will “chirp” two times every 30 seconds. This is an “operational end of life” feature which will indicate that it is time to replace the alarm.

To help identify the date to replace the unit, a label has been affixed to the side of the alarm. Write the “Replace by” date (10 years from initial power up) in permanent marker on the label prior to installing the unit.

### **Product Features and Specifications:**

- Temperature: Operating Range: 40°F (4.4°C) to 100°F (37.8°C)
- Humidity: Operating range: 10-95% non-condensing
- Audible Alarm: 85+ dB at 10' @ 3.4±0.5 KHz pulsing alarm
- Smoke Sensor: Photoelectric

# 1. LIMITATIONS OF SMOKE ALARMS



## WARNING: PLEASE READ CAREFULLY AND THOROUGHLY

- NFPA 72 states: Life safety from fire in residential occupancies is based primarily on early notification to occupants of the need to escape, followed by the appropriate egress actions by those occupants.
- Fire warning systems for dwelling units are capable of protecting about half of the occupants in potentially fatal fires. Victims are often intimate with the fire, too old or young, or physically or mentally impaired such that they cannot escape even when warned early enough that escape should be possible. For these people, other strategies such as protection-in-place or assisted escape or rescue are necessary.
- Smoke alarms are devices that can provide early warning of possible fires at a reasonable cost; however, alarms have sensing limitations. Ionization sensing alarms may detect invisible fire particles (associated with fast flaming fires) sooner than photoelectric alarms. Photoelectric sensing alarms may detect visible fire particles (associated with slow smoldering fires) sooner than ionization alarms. Home fires develop in different ways and are often unpredictable. For maximum protection, Kidde recommends that both Ionization and Photoelectric alarms be installed.
- A battery powered alarm must have a battery of the specified type, in good condition and installed properly.
- Smoke alarms must be tested regularly to make sure the battery and the alarm circuits are in good operating condition.
- Smoke alarms cannot provide an alarm if smoke does not reach the alarm. Therefore, smoke alarms may not sense fires starting in chimneys, walls, on roofs, on the other side of a closed door or on a different floor.
- If the alarm is located outside the bedroom or on a different floor, it may not wake up a sound sleeper.
- The use of alcohol or drugs may also impair one's ability to hear the smoke alarm. For maximum protection, a smoke alarm should be installed in each sleeping area on every level of a home.

***This alarm is not intended to alert hearing impaired individuals.***

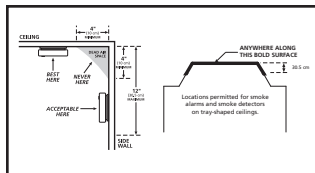

FIGURE 1

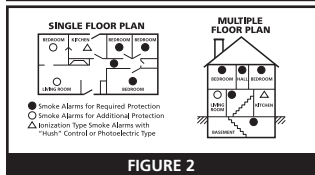

FIGURE 2

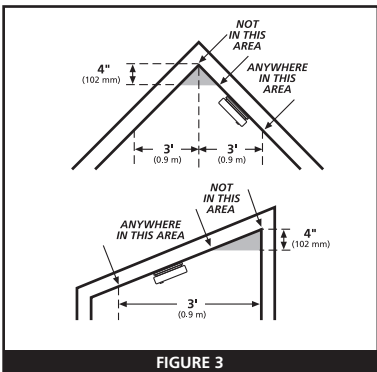

FIGURE 3

*NFPA 72 states: "Smoke alarms in rooms with ceiling slopes greater than 1 ft in 8 ft (.3m in 2.4 m) horizontally shall be located on the high side of the room." NFPA 72 states: "A row of detectors shall be spaced and located within 3 ft (0.9m) of the peak of the ceiling measured horizontally."*

## 2. RECOMMENDED LOCATIONS FOR ALARMS

- Locate the smoke alarms in all sleeping areas. Try to monitor the exit path as the bedrooms are usually farthest from the exit. If more than one sleeping area exists, locate additional alarms in each sleeping area.
- Locate additional alarms to monitor any stairway as stairways act like chimneys for smoke and heat.
- Locate at least one alarm on every floor level.
- Locate an alarm in every bedroom.
- Locate an alarm in every room where electrical appliances are operated (i.e. portable heaters and humidifiers).
- Locate an alarm in every room where someone sleeps with the door closed. The closed door may prevent an alarm not located in that room from waking the sleeper.
- Smoke, heat, and combustion products rise to the ceiling and spread horizontally. Mounting the smoke alarm on the ceiling in the center of the room places it closest to all points in the room. Ceiling mounting is preferred in ordinary residential construction.

- For mobile home installation, select locations carefully to avoid thermal barriers that may form at the ceiling. For more details, see MOBILE HOME INSTALLATION section.
- When mounting an alarm on the ceiling, locate it at a minimum of 4" (10 cm) from the side wall.
- When mounting the alarm on the wall, use an inside wall with the top edge of the alarm at a minimum of 4" (10 cm) and a maximum of 12" (30.5 cm) below the ceiling.
- Put smoke alarms at both ends of a bedroom hallway or large room if the hallway or room is more than 30 feet (9.1 m) long.
- Install Smoke Alarms on sloped, peaked or cathedral ceilings at or within 3ft (0.9m) of the highest point (measured horizontally).

**This equipment should be installed in accordance with the National Fire Protection Association's 72** (National Fire Protection Association, Batterymarch Park, Quincy, MA 02269).

### **3. LOCATIONS TO AVOID**

- In the garage. Products of combustion are present when you start your automobile.
- Normal cooking may cause nuisance alarms. If a kitchen alarm is desired, it should have an alarm silence feature or be a photoelectric type.
- Do not install within 6 ft. of heating or cooking appliances.
- Less than 4" (10cm) from the peak of an "A" frame type ceiling.
- In an area where the temperature may fall below 40°F or rise above 100°F, such as garages and unfinished attics.
- In dusty areas. Dust particles may cause nuisance alarm or failure to alarm.
- In very humid areas. Moisture or steam can cause nuisance alarms.
- In insect-infested areas.
- Smoke alarms should not be installed within 3 ft (.9m) of the door to a bathroom containing a tub or shower, forced air supply ducts used for heating or cooling, ceiling or whole house ventilating fans, or other high air flow areas.
- Near fluorescent lights. Electronic "noise" may cause nuisance alarms.
- Smoke alarms are not to be used with detector guards unless the combination (alarm and guard) has been evaluated and found suitable for that purpose.

- Do not install near vents, flues, chimneys or any forced/unforced air ventilation openings
- Do not install near fans, doors, windows or areas directly exposed to the weather.

## MOBILE HOME INSTALLATION

Modern mobile homes have been designed and built to be energy efficient. Install smoke alarms as recommended above. In older mobile homes that are not well insulated compared to present standards, extreme heat or cold can be transferred from the outside to the inside through poorly insulated walls and roof. This may create a thermal barrier which can prevent the smoke from reaching an alarm mounted on the ceiling. In such units, install the smoke alarm on an inside wall with the top edge of the alarm a minimum of 4" (10 cm) and a maximum of 12" (30.5 cm) below the ceiling.

If you are not sure about the insulation in your mobile home, or if you notice that the outer walls and ceiling are either hot or cold compared to the room air temperature, install the alarm on an inside wall. NFPA 72 (National Fire Protection Association) requires smoke alarms be installed in each sleeping area.

**⚠ WARNING: Test your smoke alarm operation after mobile home has been in storage or unoccupied and at least once a week during use.**

## 4. INSTALLATION INSTRUCTIONS

### ATTACHING MOUNTING PLATE

#### OPTION 1:

#### Easy Mount – Drywall Only

1. Choose a mounting location (wall or ceiling) and drill a 3/16" hole through drywall.
2. Insert the provided screw through the mounting plate aligning the ribs on the screw with the slots on the mounting plate.
3. Tighten the screw/mounting plate to wall or ceiling until mounting plate is very snug against surface. DO NOT over-tighten.

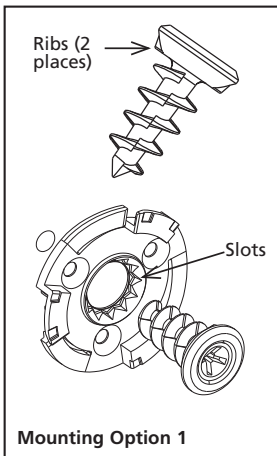

## OPTION 2:

### Mounting on Other Surfaces

1. Choose a mounting location (wall or ceiling) and using the mounting plate provided as a template, mark three-hole locations.
2. Install the three provided screws through the mounting plate and tighten. **DO NOT** over-tighten screws. (If mounting in plasterboard or similar surface, drill 3/16" holes and use the plastic anchors provided.) Anchors are not required for mounting on hard surfaces such as wood.

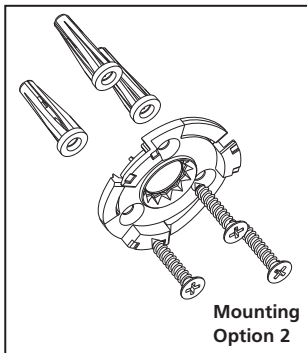

## ATTACHING AND ACTIVATING THE ALARM

This model is equipped with a feature that automatically activates the alarm when the alarm is attached to the mounting plate for the first time. Once activated, the battery will supply power to the alarm for the life of the alarm (10 years) under normal conditions.

Align the alarm with the mounting plate and rotate clockwise (right) approximately 45° until the unit stops and clicks into place. **DO NOT** over-tighten. If unit needs to be re-aligned, rotate the alarm counter clockwise, remove and rotate to desired alignment. **NOTE:** The alarm will mount to the plate in three (3) positions (every 120 degrees).

You will know power has been supplied when alarm briefly chirps. Unit will remain on until unit is disabled by the user at alarm's end of life. Do not over-tighten the alarm as damage to alarm or mounting surface may occur.

**The alarm is now activated!** After installation/activation, test your alarm as described in Operation and Testing section.

**⚠ Warning: Failure to properly install and activate this alarm will prevent proper operation of this alarm and will prevent its response to fire hazards.**

**Model P3010B** will issue a voice prompt at activation asking the user to press the test button. Proceed to Operation and testing section.



## 5. OPERATION AND TESTING

**OPERATION:** The alarm is operating once it is activated and testing is complete. When products of combustion are sensed, the unit sounds a loud 85db pulsating alarm until the air is cleared.

**TESTING:** Test your alarm by pressing the test button until the unit chirps, then release the test button. The unit will then emit 2 sets of three slow beeps.

**Model P3010B** will also issue a voice prompt stating "Fire Fire".

**Model P3010H** will briefly illuminate the amber safety light.

The alarm will sound if the electronic circuitry, horn, and battery are working. If the alarm does not sound, the unit must be replaced

**⚠ Warning: Due to the loudness (85 decibels) of the alarm, always stand an arm's length (about 2.5 feet) away from the unit or use ear protection when testing.**

**Weekly testing is required to ensure proper operation.** Erratic or low volume sound (or no sound) coming from your alarm may indicate a defective alarm and it should be returned for service. See deactivation section to determine how to prepare the unit for shipment or disposal.

**⚠ Warning: DO NOT use an open flame to test your alarm, you could damage the alarm or ignite combustible materials and start a structure fire.**

The following tables describes the visual and audible alarm conditions the unit may encounter and illustrates how the unit will indicate normal standby, alarm and error conditions.

## 6. Alarm Visual and Audible Indicators

Alarm Mode	Visual Indications	Audible Indications	Note:
Smoke or Fire detected	3 blinks synchronized with audible alarm	3 long beeps, repeating	Model P3010L
Smoke or Fire detected	3 blinks synchronized with audible alarm	3 long beeps, repeating with voice "Fire-Fire" announced	Model P3010B with Voice
Smoke or Fire detected	3 blinks synchronized with audible alarm & amber light illuminated	3 long beeps, repeating	Model P3010H with Emergency Safety Light

Operational Mode	Visual Indications	Audible Indications	Note:
<b>Normal Operation</b>	Blink once every 60 seconds	None	LED will flash every 60 seconds for 10 minutes following power on or reset. After initial 10 minutes, LED will flash once every 10 minutes
<b>Test/Hush Button Press</b>	Blink with each alarm pattern	Two sets of 3 long beeps	Test/Hush button press will initiate test sequence
		Voice "Fire-Fire" announced	Model P3010B with Voice
<b>Smoke Alarm Hush</b>	Blink once every 10 seconds	None (smoke alarm silenced)	Alarm hush feature silences smoke alarm for approx. 10 minutes. See page 13 for additional instructions.
<b>Low Battery</b>	Blink once every 30 seconds	Chirp every 60 seconds	Remove, turn off and replace alarm
		Voice "Low Battery" announced	Model P3010B with Voice
<b>Fault Mode</b>	Fault code (2-12 flashes every 30 seconds)	Chirp every 30 seconds	Remove, turn off and replace alarm
<b>End of Unit Life*</b>	2 blinks every 30 seconds	2 chirps every 30 seconds	Remove, turn off and replace alarm
<b>End of Unit Life Hush</b>	None	None (End of Life chirps silenced)	

\* End of life hush feature. Silences end of life indication 3 days at a time for a maximum of 30 days.

## GENERAL VISUAL AND AUDIBLE INDICATOR OPERATION

**Red LED Indicator:** The red LED will blink in conjunction with the alarm sound. Therefore, the red LED will blink during a smoke alarm, a low battery mode chirp, a unit error mode chirp or at end of unit life.

**Fault Mode Indicator:** These alarms monitor strategic functions of internal electronics and sensors. If a problem is detected the alarm will enter a fault mode. If this occurs the alarm will produce a single "chirp" approximately every 30 seconds and blink the Red LED 2-12 times. If this should occur call Kidde Customer service at 1-800-880-6788.

**End of Unit Life Indicator:** Ten years after initial power-up, this unit will "chirp" twice every 30 seconds to indicate that it is time to replace the alarm.

This alarm has End of Life Hush® which allows you to silence the trouble chirp for three days giving you extra time to replace the unit at a more convenient time.

To activate, press the Test/Hush button. While in the End of Life Hush® mode, the alarm will still detect Smoke.

The End of Life signal can be reset a maximum of 10 times for a total of 30 days. After 10 resets the end of life signal can no longer be silenced and the alarm must be replaced immediately.

## 7. NUISANCE ALARMS

This Smoke alarm is designed to minimize nuisance alarms. Cigarette smoke will not normally cause the unit to alarm, unless the smoke is blown directly into the alarm. Combustion particles from cooking may set off the alarm if it is located too close to a cooking appliance. Large quantities of combustible particles are generated from spills or when broiling. Using the fan on a range hood which vents to the outside (non-recirculating type) will also help remove these combustible products from the kitchen.

If the alarm does sound the smoke alarm pattern of 3 long beeps, check for fires first. If a fire is discovered, get out and call the fire department. If no fire is present, check to see if one of the reasons listed in "Locations to avoid" may have caused the alarm.

**SMART HUSH™ CONTROL:** The SMART HUSH™ feature has the capability of temporarily desensitizing the alarm circuit for approximately 10 minutes. This feature is to be used only when a known alarm condition, such as smoke from cooking, activates the alarm. The smoke alarm is desensitized by pushing the Test/Hush button on the smoke alarm cover. If the smoke is not too dense, the alarm will silence immediately and the red LED blinks every 10 seconds. This indicates that the alarm is in a temporarily desensitized condition.

**Model P3010B** will issue a voice prompt stating "Hush Mode Activated."

**Model P3010H** will turn off the amber safety light.

The smoke alarm will automatically reset after approximately 10 minutes and sound the alarm if particles of combustion are still present.

**Model P3010B** will issue a voice prompt stating "Fire-Fire."

The SMART HUSH™ feature can be used repeatedly until the air has been cleared of the condition causing the alarm. Pushing the Test/Hush button on the alarm will end the temporarily desensitized period.

**Model P3010B** will issue a voice prompt stating "Hush Mode Cancelled" after the Test/Hush button has been pressed.

If the smoke is not too dense, after ten minutes the alarm will return to normal operation.

**NOTE:** Dense smoke will override the SMART HUSH™ feature and sound a continuous alarm.

**⚠ CAUTION:** Before using the alarm SMART HUSH™ feature, identify the source of the smoke and be certain safe conditions exist.

## 8. BATTERY

### BATTERY ACTIVATION AND DEACTIVATION

**NOTE:** One Lithium-Ion battery, permanently sealed inside the alarm, powers this unit; no battery installation or replacement is necessary for the life of the alarm.

**IMPORTANT:** Constant exposure to high or low humidity may reduce battery life.

**⚠ WARNING! DO NOT ATTEMPT TO OPEN THE ALARM FOR ANY REASON!**

Do not try to repair the smoke alarm yourself. No serviceable parts included.

**Low battery:** This alarm is equipped with a low battery monitor circuit which will cause the alarm to produce a single “chirp” approximately every 60 seconds and blink the Red LED every 30 seconds, for a minimum of seven (7) days should the battery become low.

**Model P3010B** will also issue a voice prompt stating “Low battery.”

***THE UNIT MUST BE DEACTIVATED (see “Deactivation of Alarm” section) and replaced within 7 days of the first occurrence of the “Low Battery Warning” to provide continuous alarm protection.***

## 9. DEACTIVATION OF ALARM

**⚠ WARNING!**

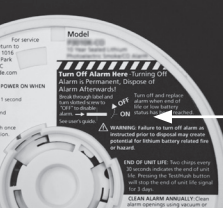

- Deactivation of the alarm is permanent. Once the alarm has been deactivated, it cannot be reactivated!
- Once deactivated, the alarm will **NO LONGER DETECT SMOKE.**
- Once the alarm is deactivated the battery will be depleted and the alarm will no longer function.
- Once the alarm has been deactivated, it cannot be mounted onto the mounting plate or reactivated.

**⚠ WARNING!** Failure to turn off alarm as instructed prior to disposal may create potential for lithium battery related fire or hazard.



## TO DEACTIVATE THE ALARM:

Remove the alarm from the mounting plate by rotating it in the direction indicated by the arrows on the cover of the alarm.

On back side of alarm, locate the   area on product label.

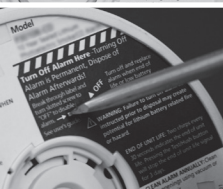

Break through label with a screw driver.

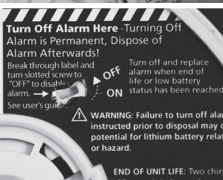

Turn the screw to the "OFF" location. This will deactivate the alarm, stop the low battery "chirp" and render the alarm safe for disposal by draining the battery.

## 10. CLEANING YOUR ALARM

### YOUR ALARM SHOULD BE CLEANED AT LEAST ONCE A YEAR

You can clean the interior of your alarm (sensing chamber) by using compressed air or a vacuum cleaner hose and blowing or vacuuming through the openings around the perimeter of the alarm. The outside of the alarm can be wiped with a damp cloth. Use only water to dampen the cloth, use of detergents or cleaners could damage the alarm.

After cleaning, test your alarm by using the test button. If cleaning does not restore the alarm to normal operation, the alarm should be replaced.

- Never use detergent or other solvents to clean the unit.
- Avoid spraying air freshener, hair spray, or other aerosols near the Smoke Alarm.
- Do not paint the unit. Paint will seal the vents and interfere with the sensor's ability to detect smoke.

- Never attempt to disassemble the unit or clean inside. This action will void your warranty.

## **11. GOOD SAFETY HABITS**

### **DEVELOP AND PRACTICE A PLAN OF ESCAPE**

Prepare and practice a home escape plan twice a year, including drills at night. Know two ways out of every room (door & window) and identify a meeting place outside the home where everyone will gather once they have exited the residence. When two people have reached the meeting place, one should leave to call 911 while the second person stays to account for additional family members. Establish a rule that once you're out, you never reenter under any circumstance!

- Make a floor plan indicating all doors and windows and at least two (2) escape routes from each room. Second story windows may need a rope or chain ladder.
- Have a family meeting and discuss your escape plan, showing everyone what to do in case of fire and where to meet after they leave the house.
- Ensure that small children hear the alarm and wake when it sounds. They must wake up in order to execute the escape plan. Practice allows all occupants to test your plan before an emergency. You may not be able to reach your children. It is important they know what to do.
- Familiarize everyone with the sound of the smoke alarm and train them to leave your home when they hear it.
- Current studies have shown smoke alarms may not awaken all sleeping individuals, and that it is the responsibility of individuals in the household that are capable of assisting others to provide assistance to those who may not be awakened by the alarm sound, or to those who may be incapable of safely evacuating the area unassisted.
- Install and maintain fire extinguishers on every level of the home and in the kitchen, basement and garage. Know how to use a fire extinguisher prior to an emergency.

### **FIRE PREVENTION**

Never smoke in bed, or leave cooking food unattended. Teach children never to play with matches or lighters! Train everyone in the home to recognize the alarm pattern and to leave the home using their escape plan when it's heard. Know how to do "Stop, Drop and Roll" if clothes catch on fire, and how to

crawl low under smoke. Install and maintain fire extinguishers on every level of the home and in the kitchen, basement and garage.

## **NFPA (NATIONAL FIRE PREVENTION ASSOCIATION)**

For your information, the National Fire Protection Association's Standard 72, reads as follows:

Smoke Detection. Where required by applicable laws, codes, or standards for the specified occupancy, approved single and multiple-station smoke alarms shall be installed as follows:

(1) In all sleeping rooms. (2) Outside of each separate sleeping area, in immediate vicinity of the sleeping rooms. (3) On each level of the dwelling unit, including basements Exception: In existing one- and two-family dwelling units, approved smoke alarms powered by batteries are permitted.

## **SMOKE DETECTION – ARE MORE SMOKE ALARMS DESIRABLE?**

The required number of smoke alarms might not provide reliable early warning protection for those areas separated by a door from the areas protected by the required smoke alarms. For this reason, it is recommended that the householder consider the use of additional smoke alarms for those areas for increased protection. The additional areas include the basement, bedrooms, dining room, furnace room, utility room, and hallways not protected by the required smoke alarms. The installation of smoke alarms in attics (finished or unfinished), garages, or within 6' of a heating or cooking appliance is not normally recommended, as these locations occasionally experience conditions that can result in improper operation.

## **CALIFORNIA STATE FIRE MARSHALL**

Early warning fire detection is best achieved by the installation of fire detection equipment in all rooms and areas of the household as follows: A smoke alarm installed in each separate sleeping area (in the vicinity, but outside the bedrooms), heat or smoke detectors in the living rooms, dining rooms, bedrooms, kitchens, hallways, attics, furnace rooms, closets, utility and storage rooms, basements and attached garages.

## **FCC**

This device complies with part 15 of the FCC Rules. Operation is subject to the following two conditions: (1) This device may not cause harmful interference, and (2) this device must accept any interference received, including interference that may cause undesired operation.

## **12. SERVICE INFORMATION**

During the specified warranty period Kidde will repair or replace, at its discretion any defective Kidde Smoke Alarms that are returned in a postage paid package to the following address: Kidde, Attn: Warranty Returns, 1016 Corporate Park Drive, Mebane, NC 27302, USA.

Please include your name, address and phone number along with a brief description of what is wrong with the unit. For further assistance please call our toll free Customer Service at 1-800-880-6788. Damage from neglect, abuse or failure to adhere to any of the enclosed instructions will result in termination of the warranty, and the unit will not be replaced or repaired.

This user guide and the products described herein are copyrighted, with all rights reserved. Under these copyright laws, no part of this user guide may be copied for use without the written consent of Kidde. If you require further information please contact Customer Service at 1-800-880-6788 or write us at: Kidde, 1016 Corporate Park Drive, Mebane, NC 27302. Our internet address is [www.kidde.com](http://www.kidde.com).



## TEN YEAR LIMITED WARRANTY

Kidde warrants that the enclosed alarm will be free from defects in material and workmanship or design under normal use and service for a period of ten years from the date of purchase. The obligation of Kidde under this warranty is limited to repairing or replacing the alarm or any part which we find to be defective in material, workmanship or design, free of charge, upon receiving the alarm with proof of date of purchase, postage and return postage prepaid, to Warranty Service Department, Kidde, 1016 Corporate Park Drive, Mebane, NC 27302.

This warranty shall not apply to the alarm if it has been damaged, modified, abused or altered after the date of purchase or if it fails to operate due to improper maintenance or inadequate power. Any implied warranties arising out of this sale, including but not limited to the implied warranties of description, merchantability and fitness for a particular purpose, are limited in duration to the above warranty period. In no event shall the Manufacturer be liable for loss of use of this product or for any indirect, special, incidental or consequential damages, or costs, or expenses incurred by the consumer or any other user of this product, whether due to a breach of contract, negligence, strict liability in tort or otherwise.

The Manufacturer shall have no liability for any personal injury, property damage or any special, incidental, contingent or consequential damage of any kind resulting from gas leakage, smoke, fire or explosion.

Since some states do not allow limitations of the duration of an implied warranty or do not allow the exclusion or limitation of incidental or consequential damages, the above limitations or exclusions may not apply to you. While this warranty gives you specific legal rights, you may also have other rights which vary from state to state.

The above warranty may not be altered except in writing signed by both parties hereto. Your Kidde Smoke Alarm is not a substitute for property, fire, disability, life or other insurance of any kind.

Appropriate insurance coverage is your responsibility. Consult your insurance agent. Opening the unit will void the warranty.

