

Single Pole (One location) or 3-Way (Multi-location)
Fluorescent and LED Fixture Slide Dimmer
 Cat. No. IP710-LF
 1200VA-120VAC, 60Hz, 1500VA-277VAC, 60Hz
INSTALLATION INSTRUCTIONS

For Use with LED fixtures using 0-10V dimmable power supply/drivers, Advance Transformer Mark 7™ OSRAM Sylvania Quicktronic Helios or equivalent dimmable ballasts.

WARNINGS AND CAUTIONS:

- **TO AVOID FIRE, SHOCK, OR DEATH; TURN OFF POWER AT CIRCUIT BREAKER OR FUSE AND TEST THAT POWER IS OFF BEFORE WIRING OR SERVICING FIXTURE!**
- To be installed and/or used in accordance with appropriate electrical codes and regulations.
- If you are unsure about any part of these instructions, consult an electrician.
- To avoid overheating and possible damage to this device and other equipment, use only with the appropriate LED 0-10V dimmable power supplies/drivers, Advance Transformer 120/277V Mark 7™ 0-10V ballasts or OSRAM Sylvania Quicktronic Helios electronic ballasts.

WARNINGS AND CAUTIONS:

- Use only one (1) dimmer in a 3- or 4-way circuit. The switch(es) will turn the light on at the brightness level selected at the dimmer.
- Lighting fixture and dimmer must be grounded.
- Use this device only with copper or copper clad wire.

DI-000-IP710-00D

Tools needed to install your Dimmer

- Slotted/Philips Screwdriver Electrical Tape Pliers
 Pencil Cutters Ruler

Changing the color of your Dimmer

Your Dimmer includes three color options. The Dimmer ships with the White frame attached. To change color of frame, proceed as follows:

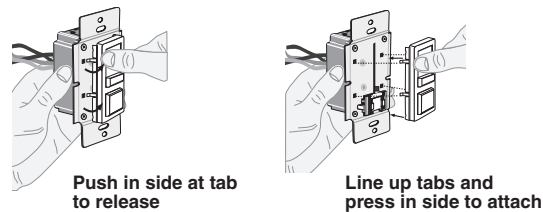

Note: Move slider on dimmer and slider on change kit to bottom of the slide bar prior to engaging.

Installing Dimmer by itself or with other devices

If installing Dimmer in a single device application, proceed with the **INSTALLING YOUR DIMMER** section. If installing Dimmer in a multi-device application, proceed as follows:

MULTI-DEVICE APPLICATION:

NOTE: You only need to remove side sections if installing with other dimmers or if it does not fit in wall box – not when installing with mechanical switches.

When installing more than one dimmer in the same location, the side sections of the mounting strap must be removed. Use pliers to carefully bend side sections back and forth until they break off.

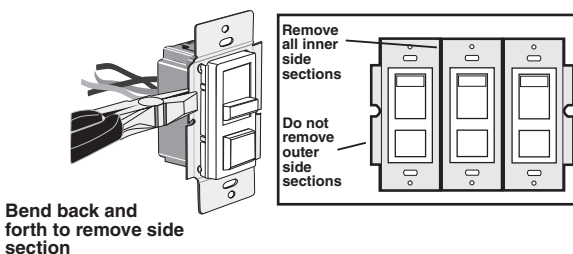

Note: No derating is required in this multi-device installation as referenced in the following chart.

MAXIMUM LOAD PER DIMMER FOR MULTI-DEVICE				
Cat. No.	Volts	Single	Two Gang	More than 2 Devices
IP710-LF	120	1200VA	1200VA	1200VA
IP710-LF	277	1500VA	1500VA	1500VA

MAXIMUM BULB WATTAGE:

0-10VDC ballasts are rated in Volt-Amps (VA). The maximum number of ballast per dimmer is based on the load VA rating. The maximum bulb wattage is determined by the efficiency of the ballast.

NOTE: For additional switching capacity, use dimmers in conjunction with a Leviton OSP20 120/277V Power Pack.

For applications using Leviton's OSP20 Power Pack (Shown in Wiring Diagrams 2 & 4), the OSP20 switch ratings are as follows (refer to OSP20 Instruction Sheet for additional information):

OSP20 SWITCH RATINGS:
 20 Amps for 120 and 277 VAC Ballast

INSTALLING YOUR DIMMER

NOTE: Use check boxes when Steps are completed.

Step 1 **WARNING: TO AVOID FIRE, SHOCK, OR DEATH; TURN OFF POWER** at circuit breaker or fuse and test that power is off before wiring!

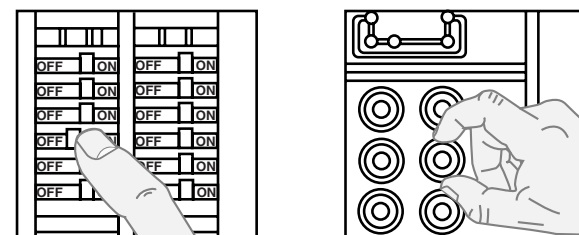

Step 2 **Identifying your wiring application (most common):**

NOTE: If the wiring in the wall box does not resemble any of these configurations, consult an electrician.

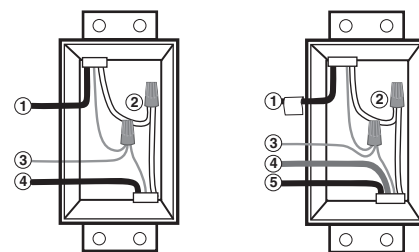

Single-Pole

1. Line (Hot)
2. Neutral
3. Ground
4. Load

3-Way

1. Line or Load Common (See important instruction below)
2. Neutral
3. Ground
4. First Traveler
5. Second Traveler

IMPORTANT: For 3-way applications, note that one of the screw terminals from the old switch being removed will usually be a different color (Black) or labeled Common. Tag that wire with electrical tape and identify as the common (Line or Load) in both the dimmer wall box and the standard 3-way switch wall box. The remaining two wires on the brass or lighter screws screw terminals of the old switch are the travelers.

Step 3 **Preparing wires:**

NOTE: Ensure that low-voltage wiring (for Gray and Violet connection of dimmer) is installed at wallbox that will house the IP710 Dimmer.

- Pull off pre-cut insulation from Dimmer leads.
- Make sure that the ends of the wires from the wall box are **straight (cut if necessary)**.
- Remove 5/8" (1.6 cm) of insulation from each wire in the wall box (shown).
- **For Single-Pole Application, go to Step 4A.**
- **For 3-Way Application, go to Step 4B.**

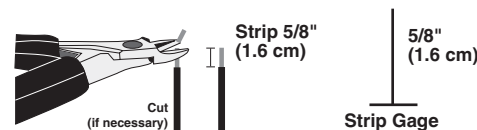

Step 4A **Single-Pole Wiring Application:**

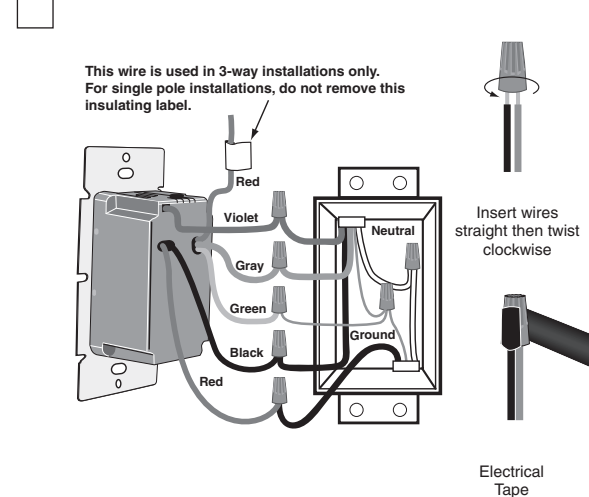

This wire is used in 3-way installations only. For single pole installations, do not remove this insulating label.

Connect wires per **WIRING DIAGRAM 1** (shown on page 2) as follows:

Screw wire nuts on clockwise making sure no bare conductors show below the wire connectors. Secure each connector with electrical tape.

NOTE: For additional switching capacity, use dimmers in conjunction with a Leviton OSP20 120/277V Power Pack.

- Green dimmer Ground lead to Green or bare copper wire in wall box.
- Black dimmer lead to Line Hot wall box wire.
- Red dimmer lead without insulating label to Load wall box wire.
- Remaining Red dimmer lead should have Red insulation label affixed.
- Violet dimmer lead to (+) Violet connection on ballast.
- Gray dimmer lead to (-) Gray connection on ballast.
- **Proceed to Step 5.**

NOTE: If insulating label is not affixed to Red lead, use a small wire nut or electrical tape to cap off.

Step 4B **3-Way Wiring Application:**

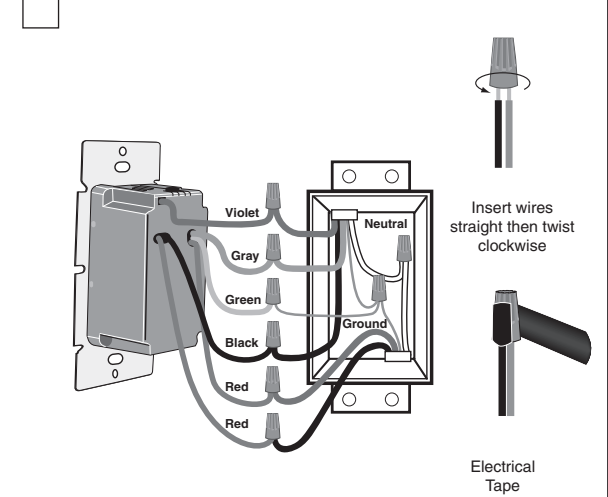

Connect wires per **WIRING DIAGRAM 3** (shown on page 2) as follows:

Screw wire nuts on clockwise making sure no bare conductors show below the wire connectors. Secure each connector with electrical tape.

NOTE: Dimmer can be installed on either the Load or Line side.

NOTE: Ensure that low-voltage wiring (for Gray and Violet connection of dimmer) is installed at wallbox that will house the IP710 Dimmer.

NOTE: For additional switching capacity, use dimmers in conjunction with a Leviton OSP20 120/277V Power Pack.

- Green dimmer Ground lead to Green or bare copper wire in wall box.
- Black dimmer lead to tagged (common) wall box wire identified in step 2.
- Remove Red insulating label from Red lead.
- First Traveler wall box wire identified in step 2 to any red dimmer lead.
- Second Traveler wall box wire identified in step 2 to the remaining red dimmer lead.
- Violet dimmer lead to (+) Violet connection on ballast.
- Gray dimmer lead to (-) Gray connection on ballast.
- **Proceed to Step 5.**

Step 5 Testing your Dimmer prior to mounting in wall box:

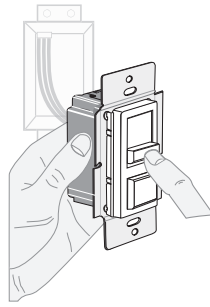

- Restore power at circuit breaker or fuse.
- Carefully holding Dimmer as shown, move slider control lever to highest position. Lights should turn ON to brightest level. If lights do not turn ON, depress push-button switch once. Lights should turn ON to brightest level. **If lights still do not turn ON, refer to the TROUBLESHOOTING section.**

OPERATION

NOTE: If using the dimmer in a 3-way application, the lights will turn ON at brightness set on dimmer's slide control lever. The lights can be controlled from either the dimmer or the switch location.

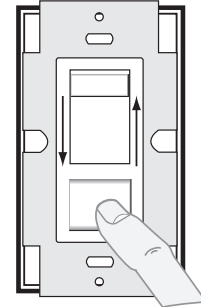

- ON/OFF:**
Depress push-button switch to ON position - Lights will turn ON.
Depress push-button switch to OFF position - Lights will turn OFF.
- BRIGHTEN & DIM:**
Move slider control lever - Lights will BRIGHTEN or DIM.

Step 6 Dimmer Mounting: **TURN OFF POWER AT CIRCUIT BREAKER OR FUSE.**

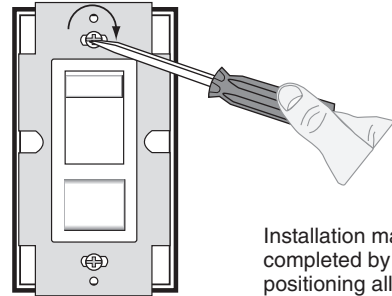

Installation may now be completed by carefully positioning all wires to provide room in wall box for dimmer. Mount dimmer into box with mounting screws supplied. Attach wallplate.

TROUBLESHOOTING

- Lights Flickering
 - Lamp has a bad connection.
 - Wires not secured firmly with wire connectors.
- Light does not turn ON
 - Circuit breaker or fuse has tripped.
 - Lamp is burned out.
 - Lamp Neutral connection is not wired.

NOTE: If further information is needed in identifying the HOT wire in a 3-Way application, go to *Leviton's website at www.leviton.com*.

Step 7 Restore Power: Restore power at circuit breaker or fuse. **Installation is complete.**

For non-standard wiring applications, refer to Wire Nut and Connector Size Chart

WIRE CONNECTOR / # OF COND. COMBINATION CHART
1- #12 w/ 1 to 3 #14, #16 or #18
2- #12 w/ 1 or 2 #16 or #18
1- #14 w/ 1 to 4 #16 or #18
2- #14 w/ 1 to 3 #16 or #18

For additional information, contact Leviton's Techline at 1-800-824-3005 or visit Leviton's website at www.leviton.com

This product is covered by U.S. Pat. No. 6,037,553 and corresponding foreign patents.
© 2012 Leviton Manufacturing Co., Inc.
All Rights Including Trade Dress Rights Reserved

Wiring Diagram 1 : Single Location Control

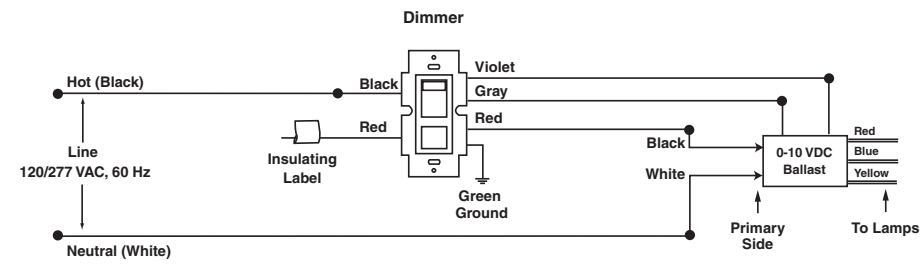

Wiring Diagram 2 : Single Location Control with OSP20 Power Pack Application

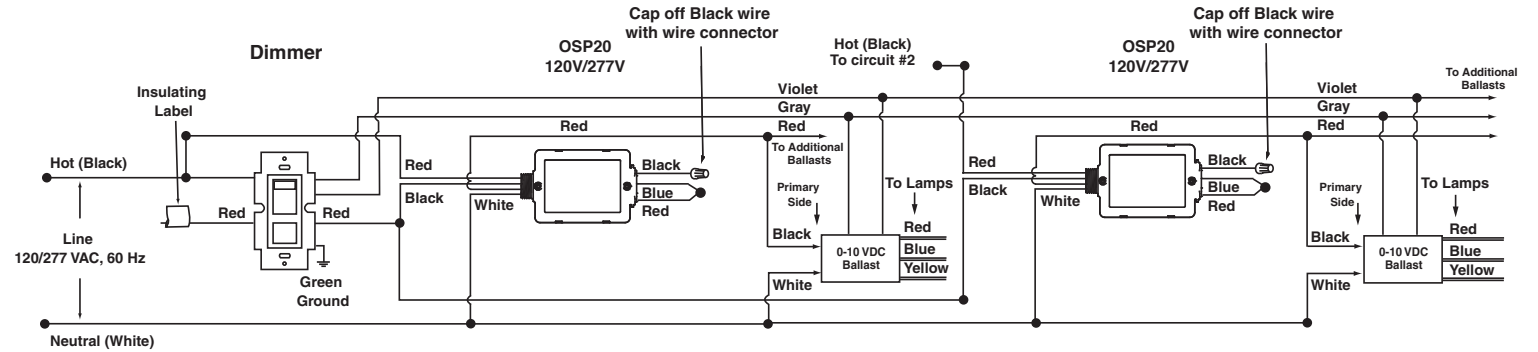

Wiring Diagram 3: Two Location Control

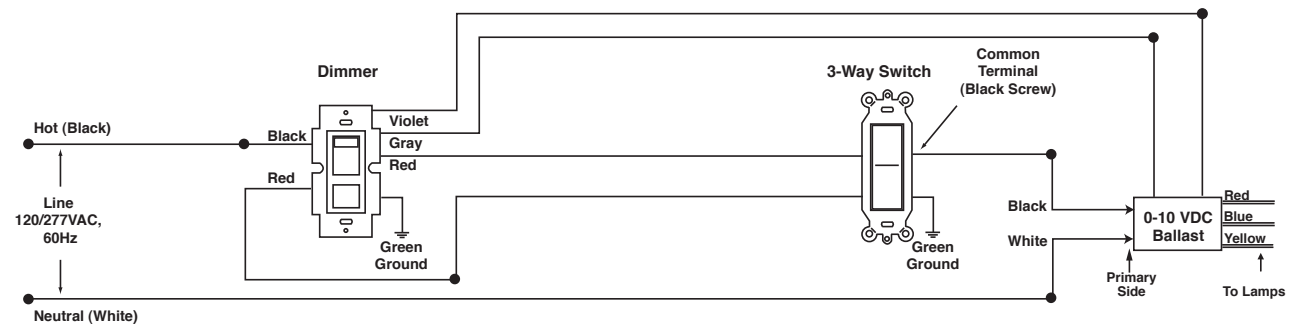

Wiring Diagram 4: Two Location Control with OSP20 Power Pack Location

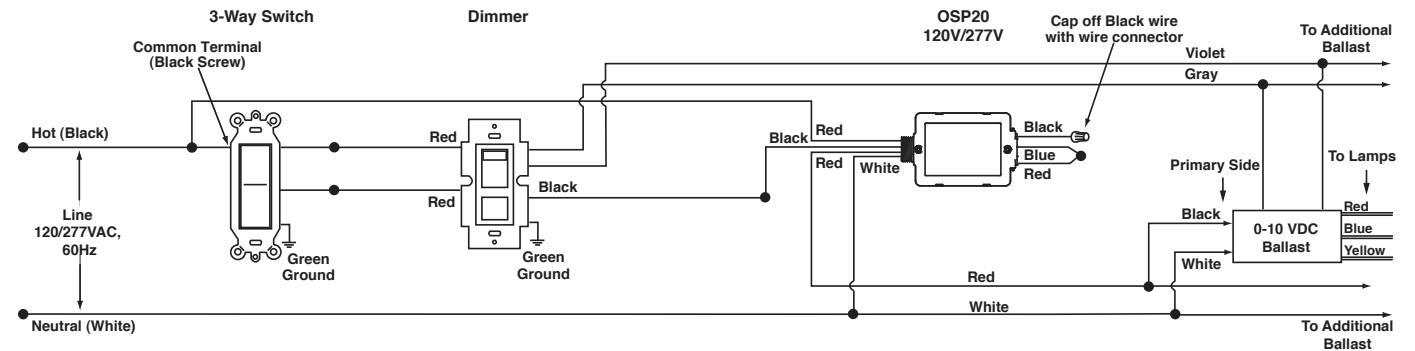

LIMITED 5 YEAR WARRANTY AND EXCLUSIONS

Leviton warrants to the original consumer purchaser and not for the benefit of anyone else that this product at the time of its sale by Leviton is free of defects in materials and workmanship under normal and proper use for five years from the purchase date. Leviton's only obligation is to correct such defects by repair or replacement, at its option, if within such five year period the product is returned prepaid, with proof of purchase date, and a description of the problem to **Leviton Manufacturing Co., Inc., Att: Quality Assurance Department, 201 North Service Road, Melville, New York 11747**. This warranty excludes and there is disclaimed liability for labor for removal of this product or reinstallation. This warranty is void if this product is installed improperly or in an improper environment, overloaded, misused, opened, abused, or altered in any manner, or is not used under normal operating conditions or not in accordance with any labels or instructions. **There are no other or implied warranties of any kind, including merchantability and fitness for a particular purpose, but if any implied warranty is required by the applicable jurisdiction, the duration of any such implied warranty, including merchantability and fitness for a particular purpose, is limited to five years. Leviton is not liable for incidental, indirect, special, or consequential damages, including without limitation, damage to, or loss of use of, any equipment, lost sales or profits or delay or failure to perform this warranty obligation.** The remedies provided herein are the exclusive remedies under this warranty, whether based on contract, tort or otherwise.