



Catalog Number	
Project	Type



Tapered Back Saber LED Area Light LSBT SERIES



Shown with optional Quick Mount Bracket (QMB)

FEATURES & SPECIFICATIONS

APPLICATION — The high performance luminaire is designed for area lighting applications where long life, low maintenance, and consistent color rendering is required. Areas with limited accessibility due to fixture location or where heavy pedestrian or vehicle traffic makes maintenance difficult are ideal applications such as parking lots or walkways. It is also compact and versatile enough for general purpose security lighting.

CONSTRUCTION — The heavy duty housing is constructed of extruded aluminum. The optical assemblies are sealed in place using a silicone gasket for weather tight protection. Modular LED bricks wired in parallel for ease of maintenance. ETL listed for wet locations (IP64). Additional IP66 rating available upon request.

FINISH — A Super Durable Polyester powder coat finish is electrostatically applied in our state of the art paint facility. Standard colors available: Black, Bronze, US Green, White. Custom colors available upon request.

OPTICAL SYSTEM — Made with a state of the art UV stabilized acrylic high performance refractive optical assemblies that use high transmittivity materials to achieve precise photometric distributions. Available in Type II, III, IV, IV Automotive, V Medium and V Wide beam configurations. Star Light Friendly (meets or exceeds Dark Sky requirements) in the horizontal position.

ELECTRICAL SYSTEM — Available in up to a 6 brick LED system in 5000K Cool White (+/- 500K) or 4100K Neutral White color temperatures (70 CRI min.) propagated with Philips Lumileds LUXEON® T LED's or Osram equivalent. Available with 90-300V 50/60 Hz Class II power supply. LED's rated over 355,000 hours (TM21 Calculated L70) at 25°C ambient temperature with selectable 700mA, 1050mA and 1400mA operation. Lumen Maintenance >97% at 50K hrs. 347V and 480V input options available. Standard 0-10V dimming. Fixture provided with integral 10kV surge protection that meets IEEE C62.42.2-2002. Built-in Active PFC Function. LED Power Supply conforms to UL1310 Class 2 and UL8750 standards and is IP67 rated for wet locations.

MOUNTING — The fixture is designed to mount directly to a square pole. An adaptor is available for direct mount to round poles. Techlight's Quick Mount Bracket for flush mount or the Quick Mount Bracket with various arm lengths also available. All mounting options allow the Tapered Back Saber to mount at 90 degree intervals.

LISTINGS — LED Power Supply listed for wet locations (IP67). LED bricks ETL listed for wet locations (IP64). Meets US and Canadian safety standards. -40°C to 50°C ambient operation. RoHS Compliant.

WARRANTY — The complete luminaire is covered by a 5-year limited warranty.

ORDERING INFORMATION

Choose the bold face options for the appropriate luminaire configuration for your application and enter on the line above each fixture attribute. Accessories may be factory installed, depending on the particular accessory chosen, but still be ordered as a separate line item.

Example: **LSBT6C8T5WD1-BZ**
QMB

Series	# of Bricks	Color Temp	# LED's per Brick	Optics	Drive Current	Voltage	Options	Finish
LSBT	1 1 Brick 2 2 Brick 3 3 Brick 4 4 Brick 5 5 Brick 6 6 Brick	C Cool White (5000K) N Neutral White (4100K)	8 18 LED	T2 Type II T3 Type III T4 Type IV T4A Type IV Automotive T5M Type V Medium T5W Type V Wide	C 700mA Driver D 1050mA Driver F 1400mA Driver	1 Multi-Volt 2 480V 3 347V	L Left Rotated Optics R Right Rotated Optics (Leave Blank for standard optics)	BK Black BZ Bronze GR US Green WH White SP Special ²

Accessories (Order as separate line items)

LEDEB18-325	2000 Lumen/90 Minute Battery Back-Up	TLWSFSIR-100	(Lenses Ordered Separately)
QMB	Quick Mount Bracket - Flush, No Arm	TLWSFSP-L2	Remote Handheld Sensor Configuration Tool
QMSSA-S	Quick Mount Bracket with 2" Straight Arm	TLWSFSP-L3	360° lens, maximum coverage 48" diameter from 8' height
QMSSA-M	Quick Mount Bracket with 8" Straight Arm	TLWSFSP-L4	360° lens, maximum coverage 40" diameter from 20' height
QMSSA	Quick Mount Bracket with 10.75" Straight Arm	TLWSFSP-L7	360° lens, maximum coverage 60" diameter from 40' height
RPASSA	Round Pole Mount Adaptor for Direct Mounting	PTLJP-275	360° lens, maximum coverage 100" diameter from 40' height
IP66 ³	Additional IP66 Fixture Rating	PPCR/D7	7-Pin Twist-Lock Photocell Receptacle ANSI C136.41
LEDOPTIC-W	Spill Light Elimination	PC2	480V Twist-Lock Photocell
LEDOPTIC-B	Spill Light Elimination "Black Out"	PC6	Multi-Tap (105-285V) Twist-Lock Photocell
TLWSFSP-211	Fixture Mount Passive Infrared Motion Sensor		

NOTES

- 1 Multi-Volt is an auto ranging power supply from 90V to 300V input.
- 2 Custom RAL color matching is available. Contact your Techlight sales representative for additional information.
- 3 Additional IP66 rating may not be changed once production has begun on the fixtures.

LSBT Tapered Back Saber LED Area Light

PHOTOMETRICS

IES INDOOR REPORT
PHOTOMETRIC FILE
NAME: LSBT6C8T3D1

Type III Optical Assembly
6 Brick, 1050mA, Cool
White

365W LSBT LED Area Light
Color Temperature: 5,000 K

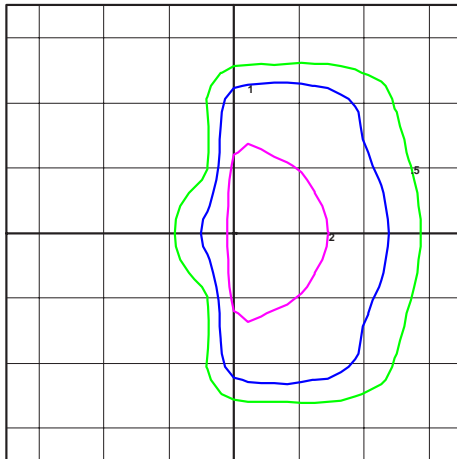

TECHLIGHT
LSBR6C8T3D
LED COOL WHITE LUXEON T (1050mA)
Horizontal Footcandles
Scale: 1 inch = 30 Ft.
Light Loss Factor = 1.00
Lumens Per Lamp = N.A. (absolute photometry)
Luminaire Lumens = 25992
Mounting Height = 30.00 Ft
Maximum Calculated Value = 3.48 Fc
Arrangement: Single

IES INDOOR REPORT
PHOTOMETRIC
FILE NAME:
LSBT6C8T5WD1

Type V Wide Optical
Assembly
6 Brick, 1050mA, Cool
White

365W LSBT LED Area Light
Color Temperature: 5,000 K

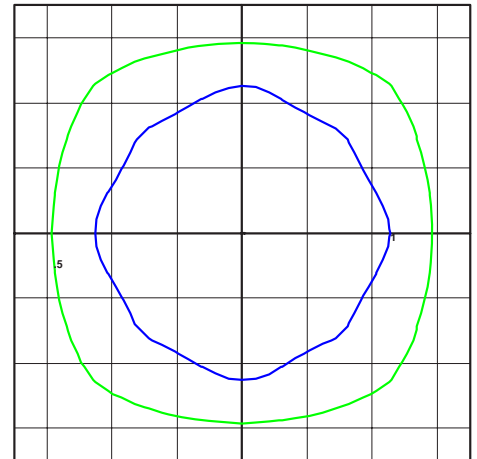

TECHLIGHT
LSBR6C8T5WD
LED COOL WHITE LUXEON T (1050mA)
Horizontal Footcandles
Scale: 1 inch = 30 Ft.
Light Loss Factor = 1.00
Lumens Per Lamp = N.A. (absolute photometry)
Luminaire Lumens = 32074
Mounting Height = 30.00 Ft
Maximum Calculated Value = 1.99 Fc
Arrangement: Single

ADDITIONAL FIXTURE DIMENSIONS

Dimensions for 1 & 2 Brick Unit

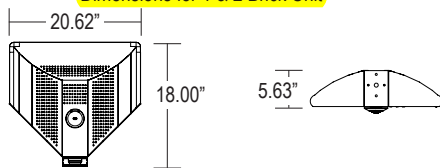

Dimensions for 3 & 4 Brick Unit

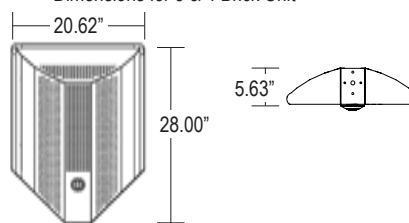

Dimensions for 5 & 6 Brick Unit

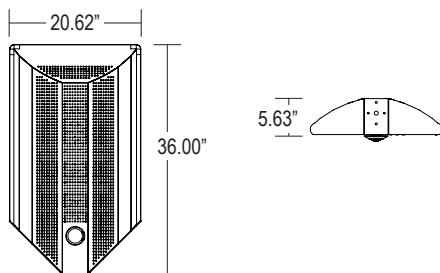

LSBT Tapered Back Saber LED Area Light

LUMINAIRE CHARACTERISTICS

Cool White (5000K) 700 mA Drive Current

# of LED Bricks	# of LEDs per Brick	Color Temp	Delivered Lumens						System Wattage	L70 @ 25°C	Amperage Draw					
			TYPE II	TYPE III	TYPE IV	TYPE 4A	TYPE 5M	TYPE 5W			120V	208V	240V	277V	347V	480V
1 BRICK	18	CW	4056	3993	4041	3992	4014	4065	41	>495K	0.35 A	0.21 A	0.18 A	0.16 A	0.13 A	0.09 A
2 BRICK	18	CW	8111	7987	8081	7983	8027	8130	81	>495K	0.70 A	0.41 A	0.35 A	0.31 A	0.25 A	0.18 A
3 BRICK	18	CW	12167	11980	12122	11975	12041	12195	122	>495K	1.05 A	0.61 A	0.53 A	0.46 A	0.37 A	0.27 A
4 BRICK	18	CW	16222	15974	16162	15967	16054	16260	162	>495K	1.40 A	0.81 A	0.70 A	0.61 A	0.49 A	0.35 A
5 BRICK	18	CW	20278	19967	20203	19959	20068	20325	203	>495K	1.75 A	1.01 A	0.88 A	0.76 A	0.61 A	0.44 A
6 BRICK	18	CW	24334	23961	24243	23950	24081	24390	243	>495K	2.10 A	1.22 A	1.05 A	0.91 A	0.73 A	0.53 A

Cool White (5000K) 1050 mA Drive Current

# of LED Bricks	# of LEDs per Brick	Color Temp	Delivered Lumens						System Wattage	L70 @ 25°C	Amperage Draw					
			TYPE II	TYPE III	TYPE IV	TYPE 4A	TYPE 5M	TYPE 5W			120V	208V	240V	277V	347V	480V
1 BRICK	18	CW	5505	5421	5484	5505	5448	5518	61	>425K	0.53 A	0.31 A	0.27 A	0.23 A	0.19 A	0.14 A
2 BRICK	18	CW	11010	10841	10969	11010	10896	11035	122	>425K	1.05 A	0.61 A	0.53 A	0.46 A	0.37 A	0.27 A
3 BRICK	18	CW	16514	16262	16453	16515	16343	16553	183	>425K	1.58 A	0.91 A	0.79 A	0.69 A	0.55 A	0.40 A
4 BRICK	18	CW	22019	21682	21938	22020	21791	22070	244	>425K	2.10 A	1.22 A	1.05 A	0.91 A	0.73 A	0.53 A
5 BRICK	18	CW	27524	27103	27422	27525	27239	27588	304	>425K	2.63 A	1.52 A	1.32 A	1.14 A	0.91 A	0.66 A
6 BRICK	18	CW	33029	32523	32906	33030	32687	33106	365	>425K	3.15 A	1.82 A	1.58 A	1.37 A	1.09 A	0.79 A

Cool White (5000K) 1400 mA Drive Current

# of LED Bricks	# of LEDs per Brick	Color Temp	Delivered Lumens						System Wattage	L70 @ 25°C	Amperage Draw					
			TYPE II	TYPE III	TYPE IV	TYPE 4A	TYPE 5M	TYPE 5W			120V	208V	240V	277V	347V	480V
1 BRICK	18	CW	7932	7813	7908	7946	7859	7948	86	>355K	0.72 A	0.42 A	0.36 A	0.32 A	0.25 A	0.18 A
2 BRICK	18	CW	15864	15626	15816	15892	15718	15896	172	>355K	1.44 A	0.83 A	0.72 A	0.63 A	0.50 A	0.36 A
3 BRICK	18	CW	23796	23439	23724	23838	23577	23844	258	>355K	2.15 A	1.25 A	1.08 A	0.94 A	0.75 A	0.54 A
4 BRICK	18	CW	31728	31252	31632	31784	31436	31792	344	>355K	2.87 A	1.66 A	1.44 A	1.25 A	1.00 A	0.72 A
5 BRICK	18	CW	39660	39065	39540	39730	39295	39740	430	>355K	3.59 A	2.07 A	1.80 A	1.56 A	1.24 A	0.90 A
6 BRICK	18	CW	47592	46878	47448	47676	47154	47688	516	>355K	4.30 A	2.49 A	2.15 A	1.87 A	1.49 A	1.08 A

WARNING: Maintenance performed including the replacement of LED bricks while power is still supplied to the luminaire may result in system failures and will void the warranty.

LSBT Saber LED Area Light

LUMINAIRE CHARACTERISTICS CONTINUED

Neutral White (4100K) 700 mA Drive Current

# of LED Bricks	# of LEDs per Brick	Color Temp	Delivered Lumens						System Wattage	L70 @ 25°C	Amperage Draw					
			TYPE II	TYPE III	TYPE IV	TYPE 4A	TYPE 5M	TYPE 5W			120V	208V	240V	277V	347V	480V
1 BRICK	18	NW	3969	3908	3954	3906	3928	3978	41	>495K	.35 A	.20 A	.18 A	.15 A	.12 A	.09 A
2 BRICK	18	NW	7938	7816	7908	7813	7855	7956	81	>495K	.68 A	.39 A	.34 A	.30 A	.24 A	.17 A
3 BRICK	18	NW	11906	11724	11862	11719	11783	11934	122	>495K	1.02 A	.59 A	.51 A	.45 A	.36 A	.26 A
4 BRICK	18	NW	15875	15632	15816	15625	15711	15912	162	>495K	1.35 A	.78 A	.68 A	.59 A	.47 A	.34 A
5 BRICK	18	NW	19844	19540	19770	19531	19638	19890	203	>495K	1.70 A	.98 A	.85 A	.74 A	.59 A	.43 A
6 BRICK	18	NW	23813	23448	23724	23438	23566	23868	243	>495K	2.03 A	1.17 A	1.02 A	.88 A	.71 A	.51 A

Neutral White (4100K) 1050 mA Drive Current

# of LED Bricks	# of LEDs per Brick	Color Temp	Delivered Lumens						System Wattage	L70 @ 25°C	Amperage Draw					
			TYPE II	TYPE III	TYPE IV	TYPE 4A	TYPE 5M	TYPE 5W			120V	208V	240V	277V	347V	480V
1 BRICK	18	NW	5387	5305	5367	5302	5331	5400	61	>425K	.51 A	.30 A	.26 A	.23 A	.18 A	.13 A
2 BRICK	18	NW	10774	10609	10734	10604	10662	10799	122	>425K	1.02 A	.59 A	.51 A	.45 A	.36 A	.26 A
3 BRICK	18	NW	16161	15914	16101	15907	15994	16199	183	>425K	1.53 A	.88 A	.77 A	.67 A	.53 A	.39 A
4 BRICK	18	NW	21548	21218	21468	21209	21325	21598	244	>425K	2.04 A	1.18 A	1.02 A	.89 A	.71 A	.51 A
5 BRICK	18	NW	26935	26523	26835	26511	26656	26998	304	>425K	2.54 A	1.47 A	1.27 A	1.10 A	.88 A	.64 A
6 BRICK	18	NW	32322	31827	32202	31813	31987	32397	365	>425K	3.05 A	1.76 A	1.53 A	1.32 A	1.06 A	.77 A

Neutral White (4100K) 1400 mA Drive Current

# of LED Bricks	# of LEDs per Brick	Color Temp	Delivered Lumens						System Wattage	L70 @ 25°C	Amperage Draw					
			TYPE II	TYPE III	TYPE IV	TYPE 4A	TYPE 5M	TYPE 5W			120V	208V	240V	277V	347V	480V
1 BRICK	18	NW	6463	6362	6439	6370	6399	6473	87	>355K	.73 A	.42 A	.37 A	.32 A	.26 A	.19 A
2 BRICK	18	NW	12926	12725	12879	12739	12798	12945	174	>355K	1.45 A	.84 A	.73 A	.63 A	.51 A	.37 A
3 BRICK	18	NW	19391	19087	19317	19110	19201	19421	261	>355K	2.18 A	1.26 A	1.09 A	.95 A	.76 A	.55 A
4 BRICK	18	NW	25852	25450	25759	25478	25596	25889	348	>355K	2.90 A	1.68 A	1.45 A	1.26 A	1.01 A	.73 A
5 BRICK	18	NW	32315	31817	32193	31844	31996	32362	435	>355K	3.63 A	2.10 A	1.82 A	1.58 A	1.26 A	.91 A
6 BRICK	18	NW	38782	38174	38636	38220	38401	38862	522	>355K	4.35 A	2.51 A	2.18 A	1.89 A	1.51 A	1.09 A

LSBT Saber LED Area Light

MOUNTING ACCESSORIES

QMB

Quick Mount Bracket - Flush, No Arm

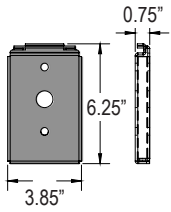

Quick Mount Bracket with no arms mounted 4 fixtures, at 90 degrees on a square pole.

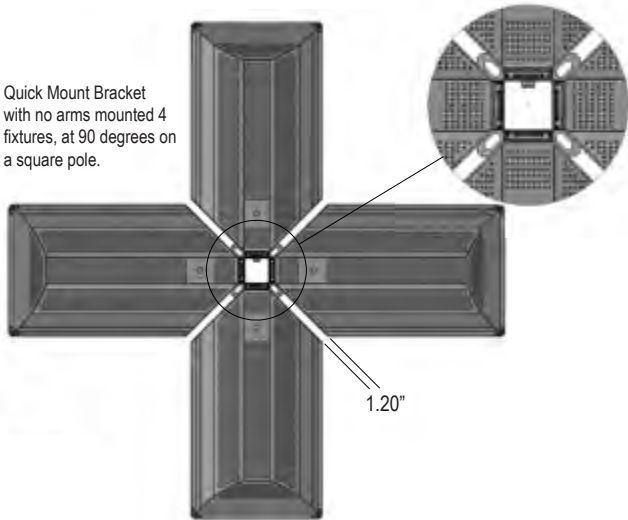

QMSSA-S

Quick Mount Bracket with 2" Straight Arm

QMSSA-M

Quick Mount Bracket with 8" Straight Arm

QMSSA

Quick Mount Bracket with 10.75" Straight Arm



RPASSA

Round Pole Mount Adaptor for Direct Mounting

