

T-SERIES

24VDC 288W DIMMABLE CLASS 2 MULTI OUTPUT LED DRIVER



CLASS 2

24V
DC

P/N: T288L24DC



Magnitude's T288L24DC is a multi-output class 2 LED dimmable LED driver. It is equipped with push-to-reset breakers, one on each output, protecting both the load and the driver. Encased in a high-quality NEMA 3R metal case enclosure, that includes 5 knock-outs to enable easy installation. All of our T- Series LED Drivers are dimmable with any standard MLV TRIAC dimmer.

QUICK SPECS

Input Voltage	Max Output Power	Output Voltage	Output Current	Efficiency @ Max Load	Power Factor @ Max. Load	Envir. Protection Rating	Weight
120VAC	96W x 3	24VDC	4 A per port	80%	> 0.9	NEMA 3R	15 lbs.

WIRING DIAGRAM

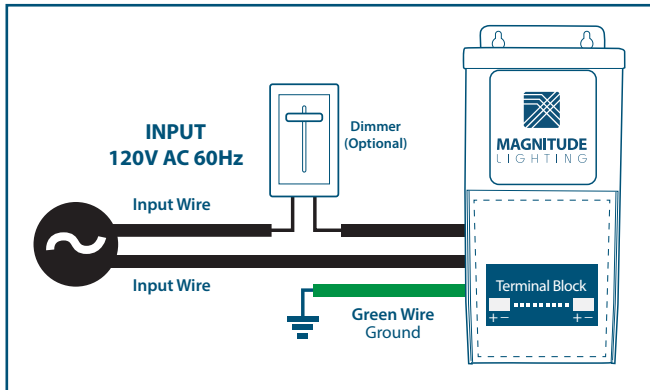

FEATURES

- Class 2
- Wiring compartment with 5 knock-outs for clean and easy installation.
- Dimmable with any standard MLV TRIAC dimmer
- Push-to-reset circuit breakers
- Commercial and Residential Use
- ETL Listed
- Certified to CSA Standard
- Nema 3R Enclosure

ENCLOSURE DETAILS In. (mm)

Length	11.33 (287.9)
Width	4.73 (120.2)
Height	4.26 (108.2)

T-SERIES 24VDC 288W DIMMABLE CLASS 2 MULTI OUTPUT LED DRIVER

SPECIFICATIONS

Input	
Input Voltage	120VAC
Input Current @ Max Load	3.4 A
Power Factor	0.9
Efficiency	80% @Max Load
Output	
Max Load	96W Per port x 3
Output Voltage	24 VDC
Output Current @ Max Load	4A per port
Open Circuit Output Voltage	24.5 VDC
Coil Former	Double Section Bobbin
Environmental	
Operating Ambient Temperature	-30°C - 40°C
Min Installation space between drivers	5" Inch
Thermal Class	B130°C
Protections	
Circuit Breaker	Primary and secondary push-to-reset
Mechanical & Housing	
Leads Primary	Terminal Blocks
Leads Secondary	Terminal Blocks
Length	11.33" (289.9mm)
Width	4.73" (120.2mm)
Height	4.26" (108.2mm)
Weight	15 lbs
Housing Material	Coated metal
Housing Color	Black
Junction Box	Yes
Mounting	Two Hole flange mounting
Approval Markings	
Certificates / Approval Signs	ETL Listed, Class 2 output

T-SERIES 24VDC 288W DIMMABLE CLASS 2 MULTI OUTPUT LED DRIVER

MECHANICAL DRAWING

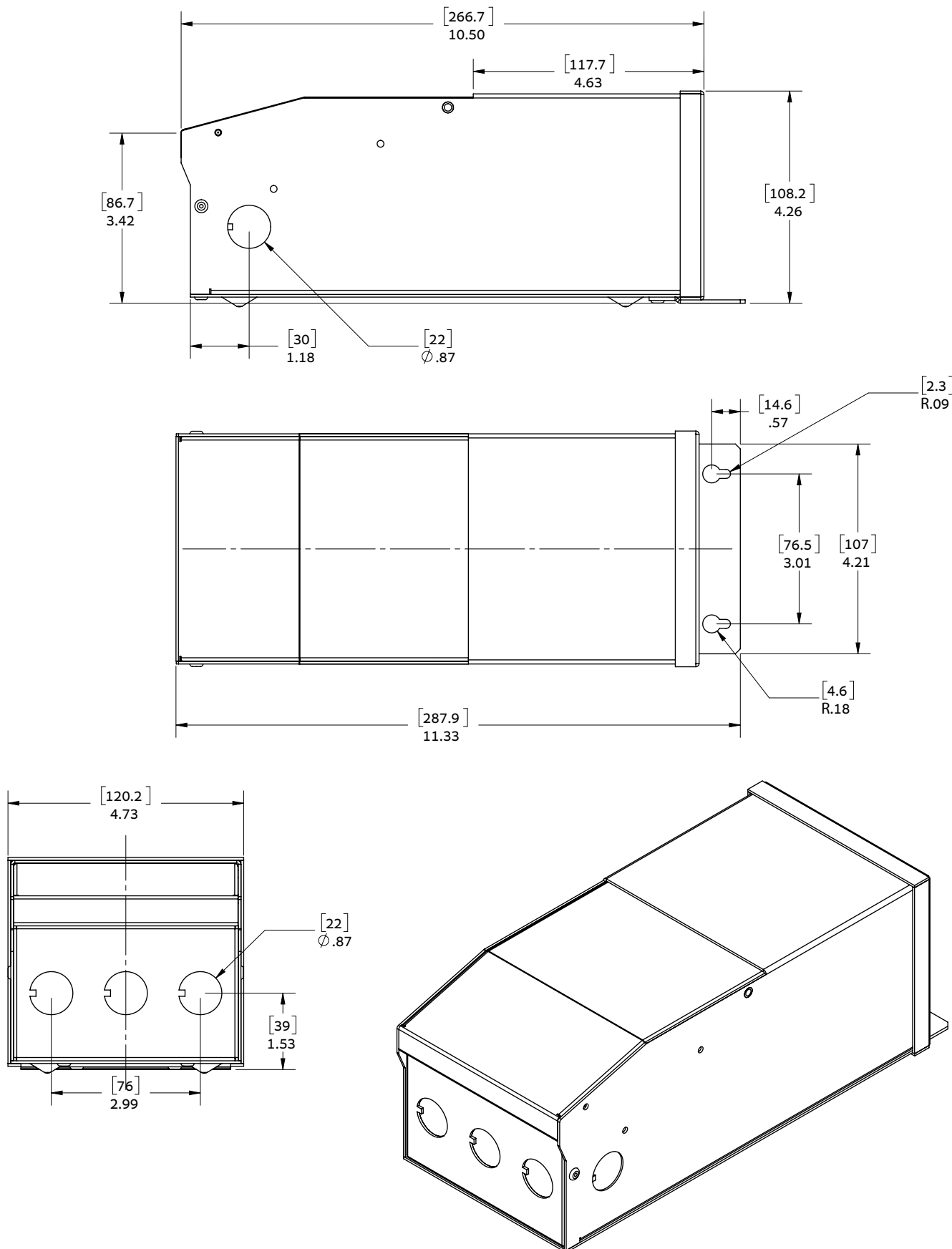

T-SERIES 24VDC 288W DIMMABLE CLASS 2 MULTI OUTPUT LED DRIVER

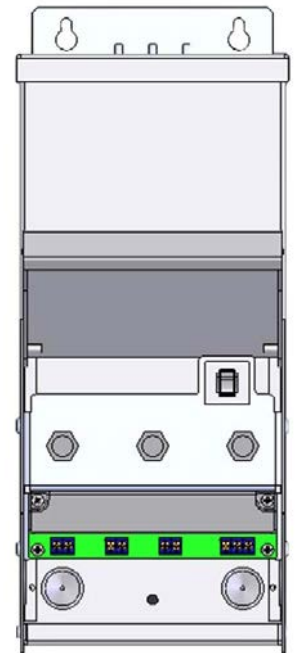
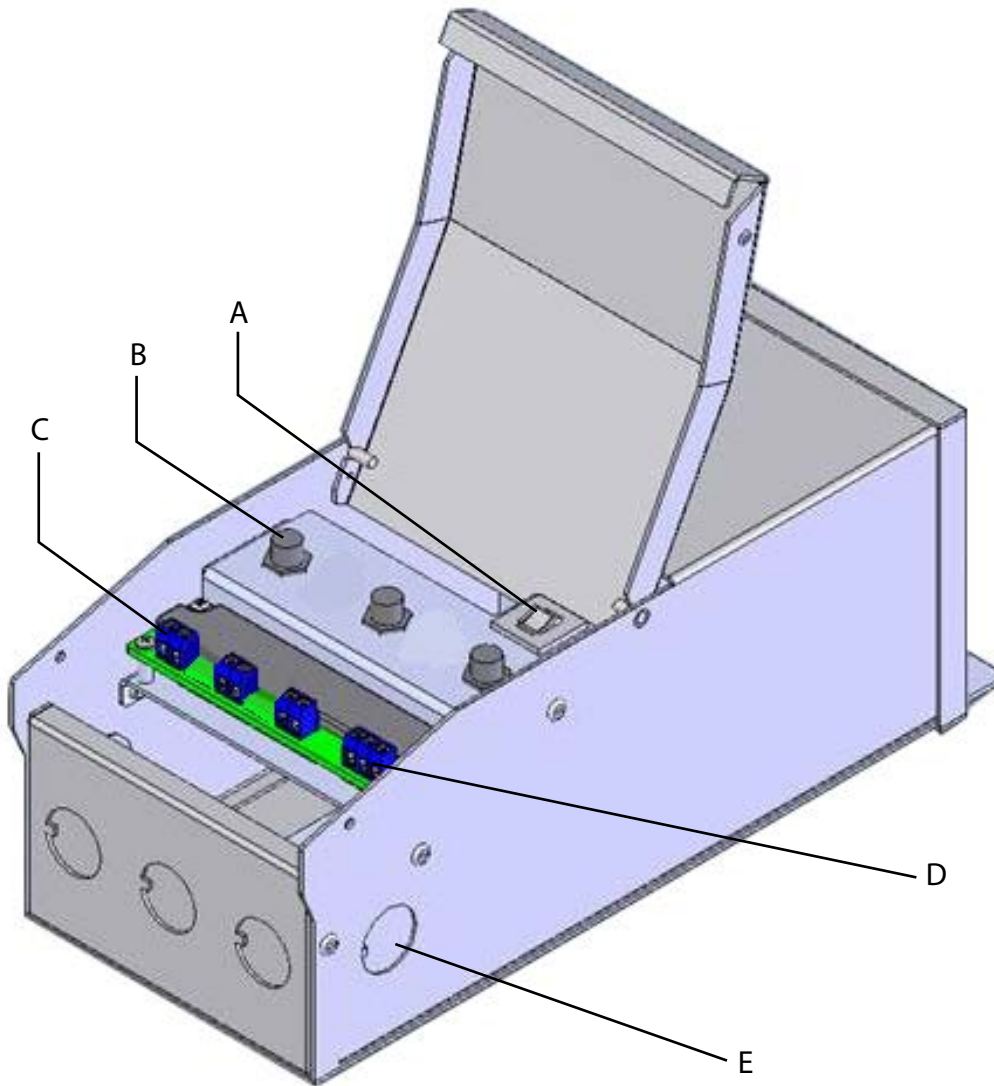

A	Primary circuit breaker
B	Secondary circuit breaker
C	Output terminal block
D	Input terminal block
E	Knockout holes