

PAR38 18.5W



OUTPUT RANGE: VIVID SERIES	930 - 1050 lumen
OUTPUT RANGE: BRILLIANT SERIES	1190 - 1280 lumen
BEAM ANGLE RANGE	9°, 25°, 36°, 60°
COLOR TEMPERATURE RANGE	2700K, 3000K, 4000K, 5000K
APPLICATION	Halogen replacement for indoor & outdoor applications



POINT SOURCE OPTICS

Exceptional beam control enables unique 9° narrow spot and smooth uniform beams

Single light source, single crisp shadow

VP₃ VIVID COLOR & VP₃ NATURAL WHITE

VIVID series provides accurate color rendering across the visible spectrum from 400nm to 700nm, with CRI/95*, R9/95*, Rf/90, Rg/100

Whiteness rendering matches or exceeds that of halogen and incandescent sources at 2700K and 3000K

ENERGY EFFICIENCY & LONG LIFE

85% more energy efficient than standard halogen lamps

Typical payback of one year or less

Rated lifetime of 35,000 hours. 3 year warranty

CERTIFICATIONS

RoHS, CE, UL/CUL, FCC Title 47 Part 15B



HIGHLY COMPATIBLE

Narrow spot compatible with Soraa SNAP System accessories

Thermally and geometrically compatible with standard fixtures and suitable for damp locations

Suitable for fully enclosed fixtures. Can be used with front glass cover

Works with trailing edge and leading edge phase cut dimmers (see www.soraa.com/resources)

INTENDED USE AND APPLICATIONS

Intended for use in PAR38 compatible recessed downlights, track lighting and other indoor and outdoor applications

Soraa lamps are designed to safely turn down in any thermal environment not conducive to minimum airflow or proper ventilation

GENERAL SPECIFICATIONS

Form Factor	Operating Temperature	Electrical	Dimming and Flicker
Width: 122mm (4.80")	Minimum: -40°C (ambient)	Wattage: 18.5W	Dimmable to <10%
Height: 125mm (4.92")	Typical: 70°C - 80°C (base)	Power factor: 0.95	Flicker Index: <0.1
Weight: 305g	Maximum: 90°C (base)	Voltage: 120V +/- 12V	Percent Flicker: 31%
		Frequency: 50/60Hz	

*Metrics apply to 2700K, 3000K, 4000K. 5000K color metrics are CRI/90, R9/95

DIMENSIONS

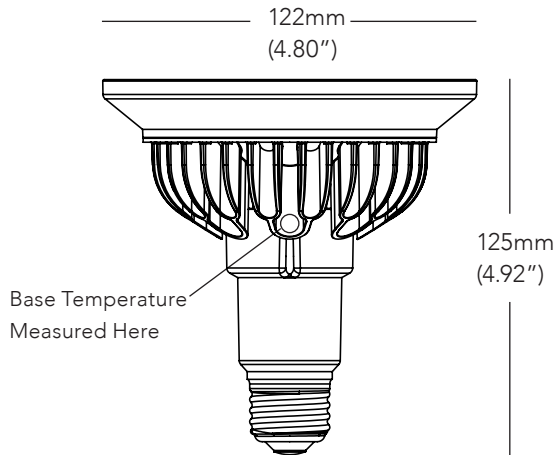

COLOR RENDERING

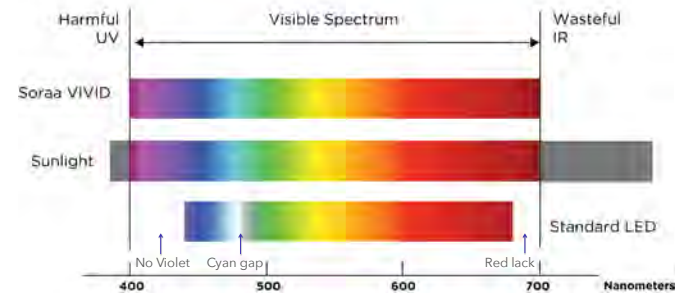

9 DEGREE BEAM

Beam Dia at 50% CBCP (ft)	Field Dia at 10% CBCP (ft)	Foot-candles (% of CBCP)
0.5	0.8	8.6%
0.9	1.7	2.5%
1.4	2.5	1.2%
1.9	3.4	0.7%
2.4	4.2	0.4%

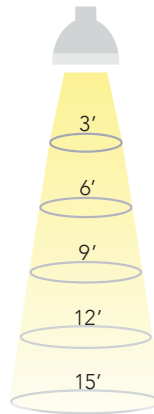

25 DEGREE BEAM

Beam Dia at 50% CBCP (ft)	Field Dia at 10% CBCP (ft)	Foot-candles (% of CBCP)
1.3	2.2	8.6%
2.7	4.4	2.5%
4.0	6.6	1.2%
5.3	8.7	0.7%
6.7	10.9	0.4%

60 DEGREE BEAM

36 DEGREE BEAM

Beam Dia at 50% CBCP (ft)	Field Dia at 10% CBCP (ft)	Foot-candles (% of CBCP)
1.9	3.5	8.6%
3.9	6.9	2.5%
5.8	10.4	1.2%
7.8	13.9	0.7%
9.7	17.3	0.4%

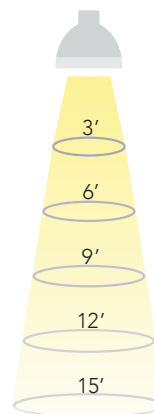

Beam Dia at 50% CBCP (ft)	Field Dia at 10% CBCP (ft)	Foot-candles (% of CBCP)
3.5	6.0	8.6%
6.9	12.0	2.5%
10.4	18.0	1.2%
13.9	24.0	0.7%
17.3	30.0	0.4%

Note: Footcandles may be calculated by multiplying the CBCP of the desired model number by the percentage in the tables above

SPECIFICATIONS BY MODEL NUMBER* SORAA LED PAR38 18.5W

Model #	Product Code	CCT (K)	Beam Angle	Field Angle	CBCP (Cd)	Halogen Equivalent	Total Flux (Lm)	Efficacy (Lm/W)	McA	Energy Star	SNAP
VIVID SERIES											
SP38-18-09D-927-03	00977	2700	9	16	17200	100	930	50	3	-	YES
SP38-18-25D-927-03	00979	2700	25	40	5020	100	930	50	3	-	-
SP38-18-36D-927-03	00981	2700	36	60	2320	100	930	50	3	-	-
SP38-18-60D-927-03	00983	2700	60	90	1020	100	930	50	3	-	-
SP38-18-09D-930-03	00993	3000	9	16	18500	100	1000	54	3	-	YES
SP38-18-25D-930-03	00995	3000	25	40	5400	100	1000	54	3	-	-
SP38-18-36D-930-03	00997	3000	36	60	2500	100	1000	54	3	-	-
SP38-18-60D-930-03	00999	3000	60	90	1100	100	1000	54	3	-	-
SP38-18-09D-940-03	01009	4000	9	16	19240	100	1040	56	4	-	YES
SP38-18-25D-940-03	01011	4000	25	40	5600	100	1040	56	4	-	-
SP38-18-36D-940-03	01013	4000	36	60	2600	100	1040	56	4	-	-
SP38-18-60D-940-03	01015	4000	60	90	1140	100	1040	56	4	-	-
SP38-18-09D-950-03	01017	5000	9	16	19420	100	1050	57	5	-	YES
SP38-18-25D-950-03	01019	5000	25	40	5660	100	1050	57	5	-	-
SP38-18-36D-950-03	01021	5000	36	60	2620	100	1050	57	5	-	-
SP38-18-60D-950-03	01023	5000	60	90	1140	100	1050	57	5	-	-
BRILLIANT SERIES											
SP38-18-09D-827-03	00985	2700	9	16	22000	120	1190	64	3	-	YES
SP38-18-25D-827-03	00987	2700	25	40	6420	120	1190	64	3	-	-
SP38-18-36D-827-03	00989	2700	36	60	2960	120	1190	64	3	-	-
SP38-18-60D-827-03	00991	2700	60	90	1300	120	1190	64	3	-	-
SP38-18-09D-830-03	01001	3000	9	16	23680	120	1280	69	3	-	YES
SP38-18-25D-830-03	01003	3000	25	40	6900	120	1280	69	3	-	-
SP38-18-36D-830-03	01005	3000	36	60	3200	120	1280	69	3	-	-
SP38-18-60D-830-03	01007	3000	60	90	1400	120	1280	69	3	-	-

CCT: Correlated Color Temperature **McA:** White Point Accuracy in McA step **SNAP:** SORAA SNAP System Compatible

*Specifications are at stable warm operating conditions (25°C ambient)

SERIES/CCT

COLOR ACCURACY

WHITENESS INDEX

SPECTRAL POWER DISTRIBUTION

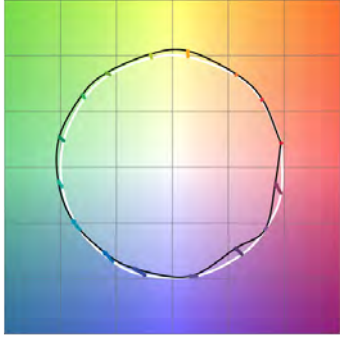
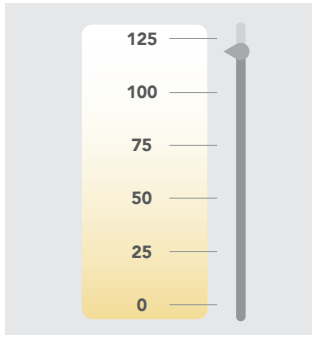
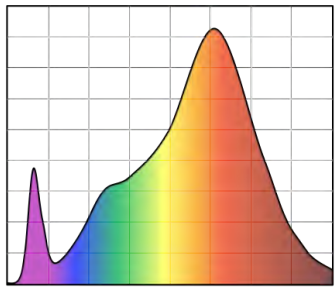
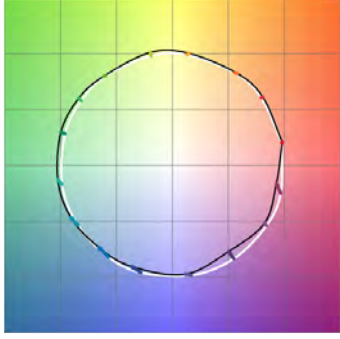
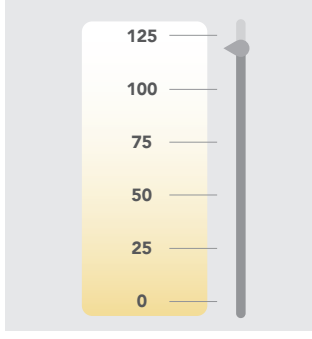
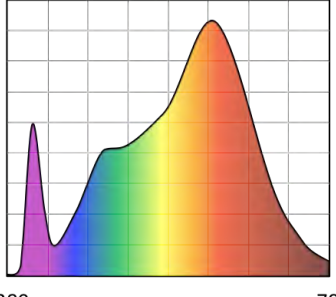
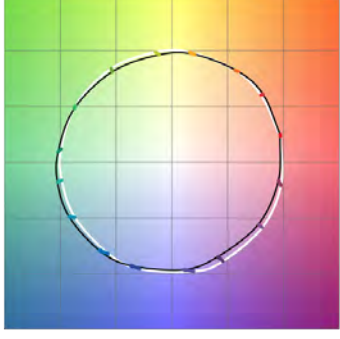
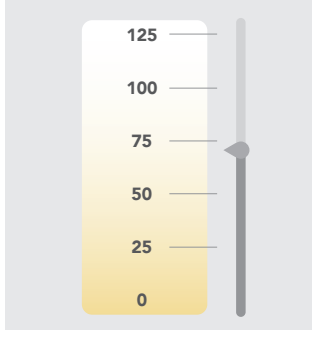
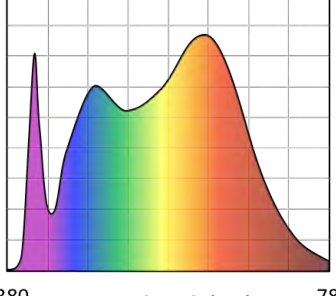
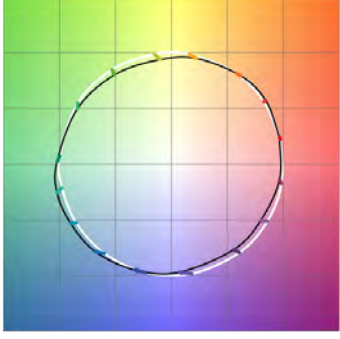
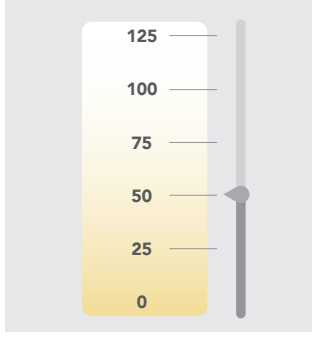
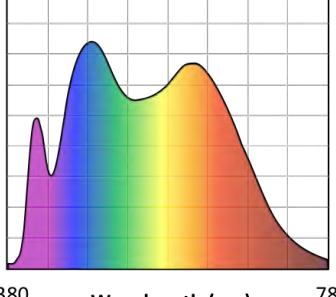
<p>VIVID 2700K</p>	 <p>Rf: 90, Rg: 100, Rfh1: 95</p>	 <p>Rw: 120</p>	 <p>380 Wavelength (nm) 780</p> <p>CRI: 95, R9: 95</p>
<p>VIVID 3000K</p>	 <p>Rf: 90, Rg: 100, Rfh1: 95</p>	 <p>Rw: 120</p>	 <p>380 Wavelength (nm) 780</p> <p>CRI: 95, R9: 95</p>
<p>VIVID 4000K</p>	 <p>Rf: 90, Rg: 100, Rfh1: 95</p>	 <p>Rw: 70</p>	 <p>380 Wavelength (nm) 780</p> <p>CRI: 95, R9: 95</p>
<p>VIVID 5000K</p>	 <p>Rf: 90, Rg: 100, Rfh1: 95</p>	 <p>Rw: 50</p>	 <p>380 Wavelength (nm) 780</p> <p>CRI: 90, R9: 95</p>

SERIES/CCT

COLOR ACCURACY

WHITENESS INDEX

SPECTRAL POWER DISTRIBUTION

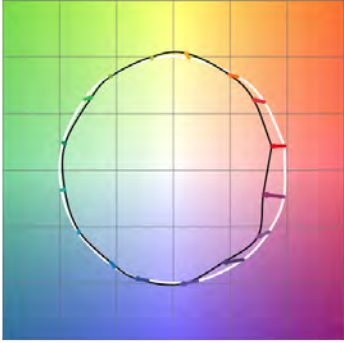
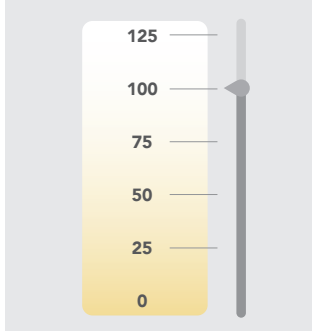
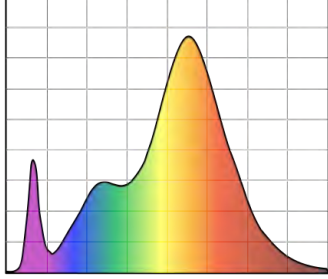
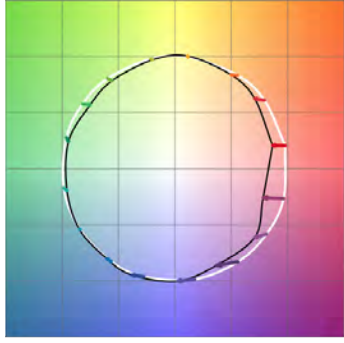
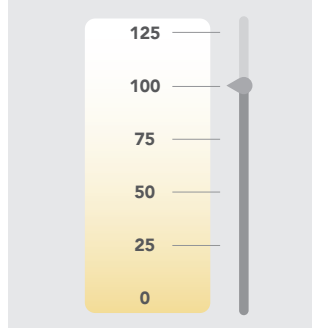
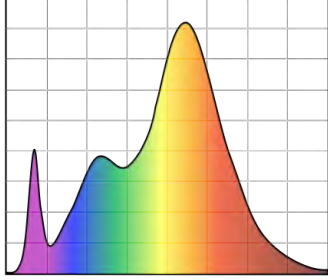
<p>BRILLIANT 2700K</p>	 <p>Rf: 85, Rg: 92, Rfh1: 77</p>	 <p>Rw: 100</p>	 <p>Wavelength (nm) 380 780</p> <p>CRI: 85, R9: >0</p>
<p>BRILLIANT 3000K</p>	 <p>Rf: 85, Rg: 92, Rfh1: 77</p>	 <p>Rw: 100</p>	 <p>Wavelength (nm) 380 780</p> <p>CRI: 85, R9: >0</p>

Rf: TM-30 metric measuring color fidelity (whether colors are similar to those under natural light). Rf is a more accurate version of the CRI Ra. Rf is 100 for natural light.
 Rg: TM-30 metric measuring color gamut (whether colors are more saturated than under natural light). Rg is 100 for natural light.
 Rfh1: TM-30 metric measuring color fidelity for red tones. Rfh1 is a more accurate version of the CRI R9. Rfh1 is 100 for natural light.
 Rw: Soraa-developed metric to measure white fidelity. Rw measures the magnitude of excitation of whitening agents within whites. Rw is about 100 for natural light.