

ELECTRICAL SPECIFICATIONS

Watts	Output Voltage	Max Output Current	Input Voltage	Dimming	Power Factor	Efficiency	Hatch Part Number
40W	12 VDC	3.33A	120VAC/277VAC	MLV TRIAC	>0.80	72%	LV40-12T-1227-KK
	24 VDC	1.67A	120VAC/277VAC	MLV TRIAC	>0.80	72%	LV40-24T-1227-KK

PRODUCT FEATURES

- Overload protection with reset
- Suitable for indoor and outdoor use
- Operating temperature range: -20°C to 40°C (measured at Tcase)
- Knockout wiring compartment
- TRIAC dimming with MLV dimmers (Please check dimmer minimum load requirement)
- 120VAC and 277VAC tap all-in-one
- Field or factory installable unit
- No Minimum Load

APPROVALS

- UL Listed 1012/1301
- Rated for Outdoor Use (Rain Tight)



MECHANICAL SPECIFICATIONS: CASE STYLE KK

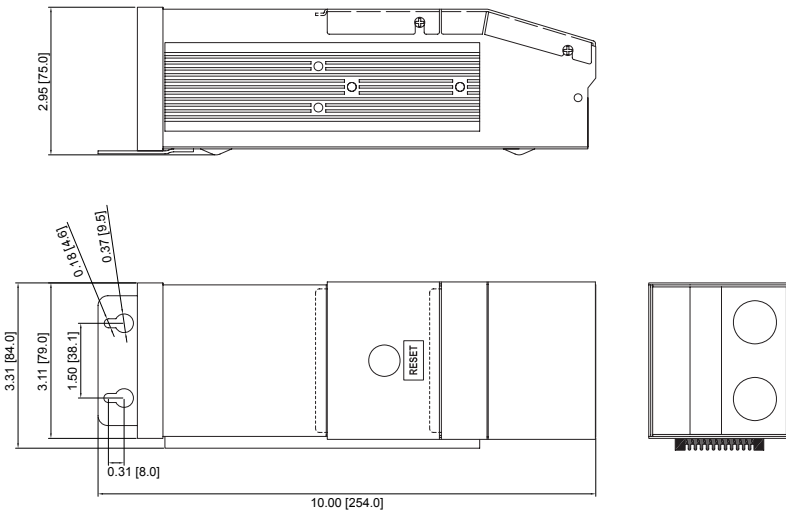

DIMENSIONS [IN/MM]

Length:	10.00 [254.0]
Mounting:	1.50 [38.1]
Width:	3.31 [79.0]
Height:	2.95 [75.0]

PACKAGING INFORMATION

Weight:	99.8 oz
Quantity:	6pc/carton

WIRING INFORMATION

Input:	6", Orange 277V (L), Black 120V (L), White (N) #18AWG
Output:	6", Red (+), Blue (-) #16AWG

CASE STYLE KK: METAL



WIRING DIAGRAMS

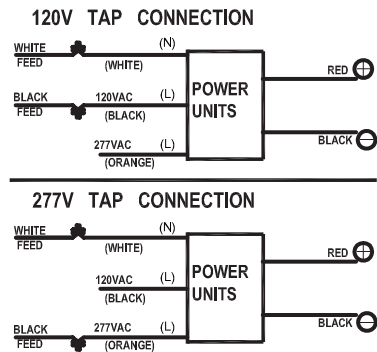

WARRANTY

- 5 years limited warranty