

MaxLite® LED Faux Cans



General Safety Information

- To reduce the risk of death, personal injury or property damage from fire, electric shock, falling parts, cuts/abrasions, and other hazards read all warnings and instructions included with and on the fixture box and all fixture labels.
- Commercial installation, service and maintenance of luminaires should be performed by a qualified licensed electrician.
- DO NOT INSTALL DAMAGED PRODUCT!

WARNING:

RISK OF ELECTRICAL SHOCK

- Turn off the electrical power at fuse or circuit breaker box before wiring fixture to power supply.
- Turn off the power when you perform any maintenance.
- Verify that supply voltage is correct by comparing it with the luminaire label information.
- Make all electrical and grounded connections in accordance with the National Electrical Code and any applicable local code requirements.
- All wiring connections should be capped with UL approved wire connectors.

CAUTION:

RISK OF INJURY

- Wear gloves and safety glasses at all times when removing luminaire from carton, installing, servicing or performing maintenance.
- Avoid direct eye exposure to the light source while it is on.
- Account for small parts and destroy packing material, as these may be hazardous to children.

CAUTION:

RISK OF FIRE

- Keep combustible and other materials that can burn away from luminaire.
- MIN 90°C SUPPLY CONDUCTORS.



Picture is for illustration purposes only.
Your model may vary.



MaxLite® LED Faux Cans

Wiring Diagram

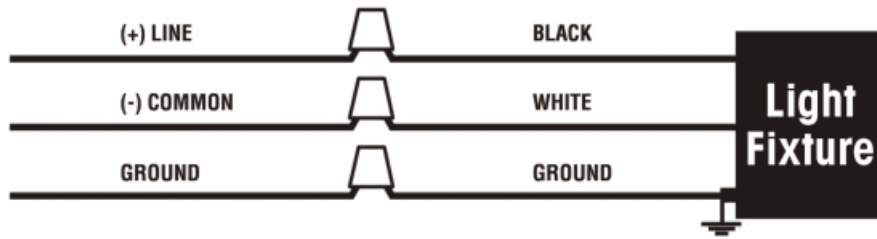

Electrical Connection:

- 1.) Provide electrical service according to the "National Electrical Code" or your local electrical code to the outlet box.
- 2.) Connect supply wires to fixture wires and insulate with proper size wire nuts (**Fig. 1**).
 - a.) Connect incoming ground wire (green or bare) to fixture ground wire (green or bare).
 - b.) Connect incoming common (white) wire to fixture common (white).
 - c.) Connect incoming hot (typically black) wire to fixture black wire.

Installation Instructions

Installation Onto Outlet Box:

- 1.) Twist lens cover counter-clockwise to remove from Faux Can.
- 2.) Attach the fixture to the outlet box by fastening supplied 1½" outlet box screws through canopy keyholes. Make sure Faux Can is flush to the ceiling. (**Fig. 1**)
- 3.) Replace the lens back on to the Faux Can by reversing step 1.

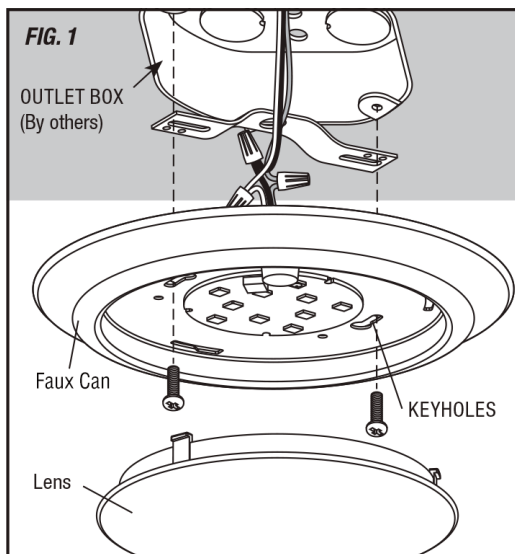

MaxLite® LED Faux Cans



Installation into 4" recessed housing

- 1.) Twist lens cover counter-clockwise to remove from Faux Can.
- 2.) Attach plastic insert to Faux Can using supplied 1/4" screws. **(Fig. 2)**
- 3.) Detach the 2 halves of the luminaire disconnect, insert black and white wires of fixture into non-wired half of luminaire disconnect following colour code marked on connector. **(Fig. 3)**
- 4.) Screw the socket adapter to socket in housing. **(Fig. 4)**
- 5.) Plug the female connector of the Faux Can onto the male connector of the socket adapter assembly. **(Fig. 4)**
- 6.) Push Faux Can through hole in plaster frame until flush with ceiling. Spring clip tension can be adjusted by bending spring clip.
- 7.) Replace the lens back on to the Faux Can by reversing step 1.

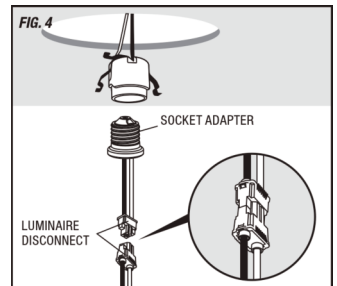
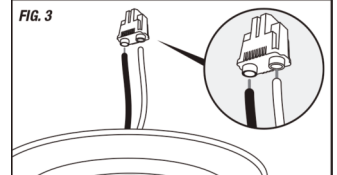
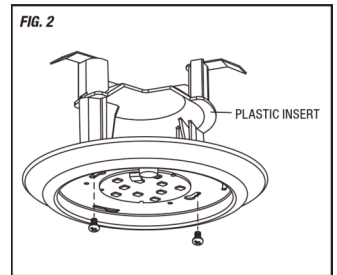

Installation into 5" & 6" recessed housing

- 1.) Insert torsion springs on to the mounting bracket. Make sure that the tab on the clips is positioned inwards.
- 2.) Attach mounting bracket to Faux Can keyholes with supplied 1/4" screws. **(Fig. 2)**
- 3.) Detach the 2 halves of the luminaire disconnect, insert black and white wires of fixture into non-wired half of luminaire disconnect following colour code marked on connector. **(Fig. 3)**
- 4.) Screw the socket adapter to socket in housing. **(Fig. 4)**
- 5.) Plug the female connector of the Faux Can onto the male connector of the socket adapter assembly. **(Fig. 4)**
- 6.) Install torsion spring of Faux Can to the spring retainer inside the housing.
- 7.) Tuck all wires into to the housing and carefully push the Faux Can into housing.

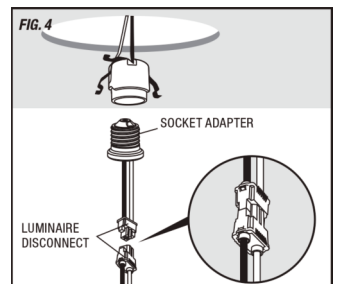
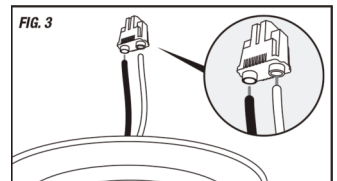
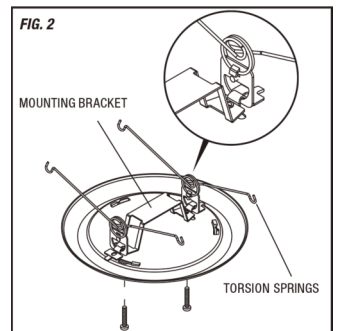

MaxLite® LED Faux Cans



Warranty Information

MaxLite Inc. warrants its products for a minimum period of **FIVE (5)** years from the date of original purchase from MaxLite or its authorized distributor/dealer (the "Warranty Period"), as follows: If a Product fails to operate during the Warranty Period as a result of defects in materials or workmanship, MaxLite will, at its option, repair it, replace it with the same or like Product.

Please refer to Maxlite's website (at <http://maxlite.com/resources/warranties>) for the complete terms and conditions of our warranty.

Limitation of Liability

THE FOREGOING WARRANTY IS EXCLUSIVE, AND IS THE SOLE REMEDY FOR ANY AND ALL CLAIMS, WHETHER IN CONTRACT, IN TORT OR OTHERWISE ARISING FROM THE FAILURE OF PRODUCT AND IS IN LIEU OF ALL OTHER WARRANTIES, EXPRESS OR IMPLIED, INCLUDING ALL WARRANTIES OF MERCHANTABILITY OR FITNESS FOR A PARTICULAR PURPOSE, WHICH WARRANTIES ARE HEREBY EXPRESSLY DISCLAIMED TO THE EXTENT PERMITTED BY LAW AND, IN ANY EVENT, SHALL BE LIMITED TO THE WARRANTY PERIOD SPECIFIED ABOVE. THE LIABILITY OF MAXLITE SHALL BE LIMITED TO THE TERMS OF THE EXPRESS WARRANTY SET FORTH HEREIN. IN NO EVENT WILL MAXLITE BE LIABLE FOR ANY SPECIAL, INCIDENTAL OR CONSEQUENTIAL DAMAGES INCLUDING, WITHOUT LIMITATION, DAMAGES RESULTING FROM LOSS OF USE, PROFITS, BUSINESS OR GOODWILL, LABOR COSTS, REMOVAL OR INSTALLATION COSTS, DECREASE IN THE LIGHT OUTPUT OF THE LAMP, AND/OR DETERIORATION IN THE LAMP'S PERFORMANCE, WHETHER OR NOT MAXLITE HAS BEEN ADVISED OF THE POSSIBILITY THEREOF. UNDER NO CIRCUMSTANCES SHALL MAXLITE'S ENTIRE LIABILITY FOR A DEFECTIVE PRODUCT EXCEED THE PURCHASE PRICE OF THAT PRODUCT. WARRANTY SERVICES PROVIDED UNDER THESE TERMS AND CONDITIONS DO NOT ENSURE THE UNINTERRUPTED OPERATION OF PRODUCTS; MAXLITE SHALL NOT BE LIABLE FOR DAMAGES CAUSED BY ANY DELAYS INVOLVING WARRANTY SERVICE.

This Limited Warranty gives you specific legal rights and you may also have other rights that may vary from state to state. Because some states or jurisdictions do not allow the exclusion or limitation of liability for consequential or incidental damages, this limitation may not apply to you.