



# GREENCREATIVE

Bringing You the Latest in LED Technology

QWIKLINK  
SERIES



STRIP QWIKLINK SERIES

# STRIP PRODUCT FEATURES

## QWIKLINK Connection System

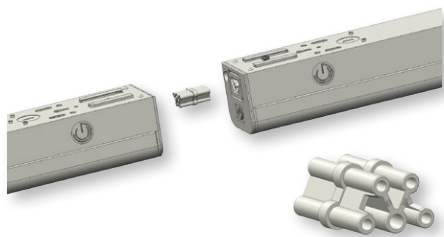

QWIKLINK Connector



QWIKLINK Cable

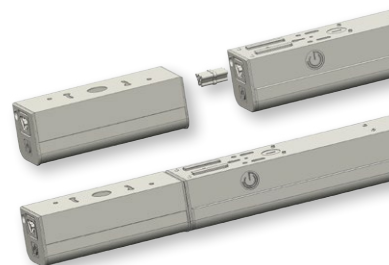

QWIKLINK Sensor

The QWIKLINK connection system uses the latest in toolless technology to easily and seamlessly connect up to 64' of fixtures. The QWIKLINK connector provides a line voltage and 0-10V dimming connection between fixtures. The QWIKLINK cable comes in two lengths (7.9in. & 5ft.) and allows for angled and distant fixture connection. The QWIKLINK sensor integrates with a single fixture or an entire row for occupancy sensing and dimming.

## Versatile Installation

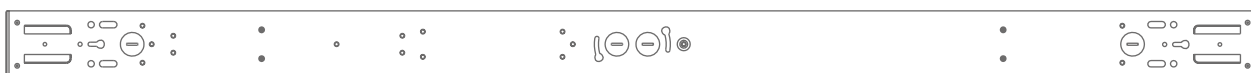
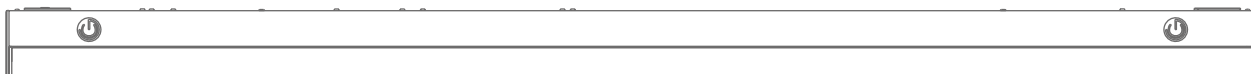

Removable light engine with safety cables for easy installation

Installation Features
Wiring Quick Connectors (x5)
Back Knockouts (x4)
Side Knockouts (x4)
Integrated Cable Clamps (x2)
QWIKLINK Sockets (x2)
Back Screw Mounts (x3)
Suspension Mounts (x2)

Each STRIP fixture installs quickly and easily. The light engine safety cable allows the whole product to be installed at once. Multiple knockouts located on each fixture allow for flexibility when wiring, regardless if the main input enters from the back or side of the product. All wiring is done using quick connectors, including 0-10V dimming, to save time during installation. Each STRIP fixture can be surface mounted using a J-box plate or suspended using aircraft cables.

# STRIP PRODUCT FEATURES

## Even Distribution & Uplighting

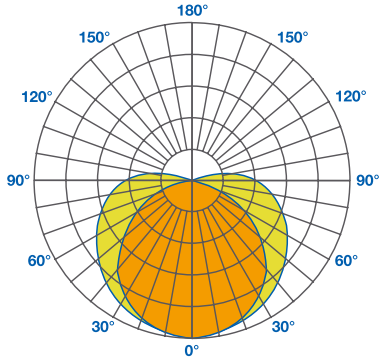

The STRIP QWIKLINK Series provides even distribution and up to 10% uplighting to limit the “cave effect” associated with other fixtures with more direct lighting. The smooth light output helps create a visually comfortable and secure environment.

## Options & Accessories

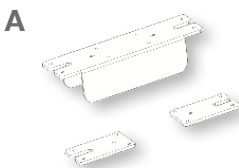

### BACK PLATES FOR SUSPENSION IN CONTINUOUS RUN

- A - Mechanical connection between suspended fixtures (use with 1 aircraft cable/fixture)
- B - Mechanical connection between suspended fixtures (use with 2 aircraft cables/fixture)



### AIRCRAFT CABLE

- For suspended mounting
- Accessory sold separately for all STRIP fixtures

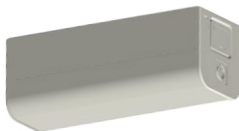

### OCCUPANCY SENSOR

- Occupancy sensor with dimming for 8' to 20' mounting heights
- Option available for all STRIP fixtures



### J-BOX MOUNTING PLATE

- Steel plate for surface mounting on round or hexagonal 4" J-boxes
- Accessory sold separately for all STRIP fixtures



### QWIKLINK CABLE

- Allows for easy electrical connection
- 7.9in. & 5ft. versions for angled or distant connection
- Accessory sold separately for all STRIP fixtures

# STRIP QWIKLINK SERIES

## STRIP 4' 22.5W & STRIP 4' 38.5W

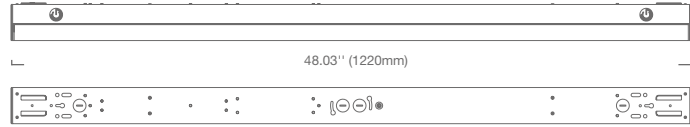

### STRIP 4' 22.5W

- 2600lm
- 115 LPW
- 120-277V universal voltage
- 3000K, 35000K, 4000K & 5000K CCT
- 100,000-hr lifetime 10-yr warranty

### STRIP 4' 38.5W

- 5050lm
- 131 LPW
- 120-277V universal voltage
- 3000K, 35000K, 4000K & 5000K CCT
- 100,000-hr lifetime 10-yr warranty

### Specifications

	Model	Product	CCT	Power (W)	Lumens (lm)	LPW	Beam Angle	CRI (typ.)	Dim	Life (hrs)	Voltage	DLC
	22.5STRIPDIM/830/277V	28317	3000K	22.5	2500	111	120°	82	Yes	100,000	120-277V	Mar. Standard
	22.5STRIPDIM/835/277V	28318	3500K	22.5	2500	111	120°	82	Yes	100,000	120-277V	Mar. Standard
	22.5STRIPDIM/840/277V	28319	4000K	22.5	2600	115	120°	82	Yes	100,000	120-277V	Mar. Standard
	22.5STRIPDIM/850/277V	28320	5000K	22.5	2600	115	120°	82	Yes	100,000	120-277V	Mar. Standard
	38.5STRIPDIM/830/277V	28321	3000K	38.5	4950	129	120°	82	Yes	100,000	120-277V	Mar. Premium
	38.5STRIPDIM/835/277V	28322	3500K	38.5	4950	129	120°	82	Yes	100,000	120-277V	Mar. Premium
	38.5STRIPDIM/840/277V	28323	4000K	38.5	5050	131	120°	82	Yes	100,000	120-277V	Mar. Premium
	38.5STRIPDIM/850/277V	28324	5000K	38.5	5050	131	120°	82	Yes	100,000	120-277V	Mar. Premium

\* Suitable for damp locations only

### Product Ordering Information

#### Must Select

Power	CRI	CCT	Voltage
22.5STRIP 22.5W	8 82	30 3000K	277V 120-277V
38.5STRIP 38.5W		35 3500K	
		40 4000K	
		50 5000K	

Ex. 22.5STRIP/840/277V/STEPDIM/EM

### Accessory Ordering Information

Model	Product	Description	Model	Product	Description
STPSENSOR	28388	Microwave Sensor QWIKLINK Connection Module 120-277V - Bi-level - Field Adjustable	STP10CABLE	28383	10' Aircraft Cable with Y-toggle (Set of 2 Cables Suitable for 1 Fixture)
SENSORRC	97881	Remote Control for STPSENSOR	STPPLATE4C	28387	Back Plate for Mechanical Connection Between Suspended Fixtures in a Continuous Run (2 Aircraft Cables Per Fixture)
JBOXPLATE	28384	J-box Cover Plate	STPPLATE2C	97855	Back Plate for Mechanical Connection Between Suspended Fixtures in a Continuous Run (1 Aircraft Cable Per Fixture)
WIRECON20	28385	7.9" (20cm) QWIKLINK Cable	PC6	97860	6' Power Cord 18/3 (Not Pre-wired to Fixture)
WIRECON150	28386	5' QWIKLINK Cable	PC12	97861	12' Power Cord 18/3 (Not Pre-wired to Fixture)
STP6CABLE	28382	6' Aircraft Cable with Y-toggle (Set of 2 Cables Suitable for 1 Fixture)			