

LUNERA HID LED

Installation Guide

Line Driven (UL Type B) / Mogul and Medium Base



Product Description:

The LUNERA HID LED Line Driven (ballast bypass) LED lamp Mogul (E39) / Medium (E26) Base is a replacement of 400W-70W HID lamps.

Read this install guide carefully prior to lamp installation.

Product SKU on the lamp must match one of the following SKUs:

Product SKU	Luminous Flux	Avg. Lamp Power	Base Type
SN-V-E39-L-20KLM-8XX-G3	20,000lm	230W	Mogul (E39/EX39)
SN-V-E39-L-15KLM-8XX-G3	15,000lm	164W	Mogul (E39/EX39)
SN-VS-E39-L-9KLM-8XX-G3	9,000lm	103W	Mogul (E39/EX39)
SN-VS-E39-L-4.5KLM-8XX-G3	4,500lm	58W	Mogul (E39/EX39)
SN-V-E26-L-9KLM-8XX-G3	9,000lm	103W	Medium (E26)
SN-V-E26-L-4.5KLM-8XX-G3	4,500lm	58W	Medium (E26)
SN-VS-E26-L-9KLM-8XX-G3	9,000lm	103W	Medium (E26)
SN-VS-E26-L-4.5KLM-8XX-G3	4,500lm	58W	Medium (E26)



Mogul Base
Up to 20,000lm

THIS LAMP IS NOT RATED FOR USE WITH HID BALLAST OR EXTERNAL LED DRIVER.

Installation Instruction - Ballast Bypass Lamp

1. Turn power off to the fixture.
2. Remove existing HID lamp from the fixture.
3. Follow the steps below to bypass the existing HID ballasts [See Figure 1].

- Step 1: Disconnect Line Voltage (Hot Wire) from the HID ballast as shown in Figure 1.
- Step 2: Disconnect Neutral (COM) from the capacitor in the HID system.
- Step 3: Disconnect the socket completely from the HID ballast.
- Step 4: If the socket has a ground wire (Green) attached to the fixture; do not disconnect the ground wire.
- Step 5: Connect Hot (120VAC-277VAC) to black wire; and Neutral to white wire connected to E39 or E26 socket [See Figure 2].

4. Make sure the socket is not damaged.
5. Install the Lunera HID LED Lamp.
6. Apply re-lamping label on a visible location inside the fixture.
7. Turn power on.



Medium Base
Up to 9,000lm

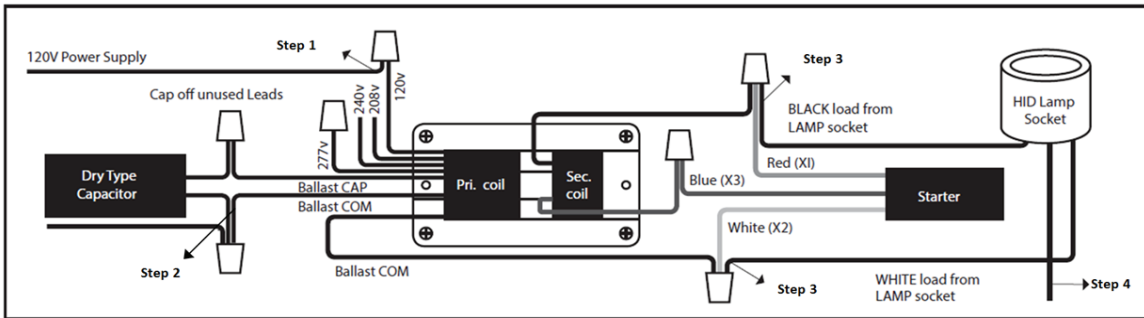

Figure 1: Bypassing the magnetic ballasts; follow steps 1 through 4 in the instructions above to bypass the HID ballast.



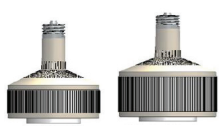





Figure 2: [Step 5] Bring Line Voltage to the Socket; Connect Hot to Black wire and Neutral to white wires connected to E39/E26 Socket.

Lamp can be installed into close bottom or open bottom fixtures. [See required luminaire dimensions on the next page.]

An example of open bottom luminaires:
Lithonia THD 400S A15 TB
An example of close bottom luminaire:
Lithonia TXC 250S A23 TB

Intended Applications

The Lunera HID LED lamp is designed to replace Metal Halide (MH) and High Pressure Sodium (HPS) lamps in the following compatible applications:

Wattage Compatibilities	Sockets	Power Source	Mount
<p>Lunera HID LED Mogul (E39) Base</p>  <p>= 400W-70W MH or HPS</p>	<p>E39 / EX39 Mogul</p> 	<p>120V-277V Line Voltage</p> 	<p>Fixture Type</p>  <p>High Bay Low Bay</p>
<p>HID LED Medium (E26) Base</p>  <p>= 400W-70W MH or HPS</p>	<p>E26 Medium</p> 		 <p>Parking Garage</p>

General Safety Information

READ AND FOLLOW ALL SAFETY INSTRUCTIONS

WARNING - RISK OF FIRE OR ELECTRIC SHOCK. LED RETROFIT KIT INSTALLATION REQUIRES KNOWLEDGE OF LUMINAIRE ELECTRICAL SYSTEM. IF NOT QUALIFIED, DO NOT ATTEMPT INSTALLATION. CONTACT A QUALIFIED ELECTRICIAN.

WARNING - IF THE LAMP OR LUMINAIRE EXHIBITS UNDESIRABLE OPERATION (BUZZING, FLICKERING, ETC) IMMEDIATELY TURN OFF POWER, REMOVE LAMP FROM LUMINAIRE AND CONTACT MANUFACTURER.

WARNING - RISK OF FIRE OR ELECTRIC SHOCK. INSTALL THIS KIT ONLY IN LUMINAIRE THAT HAVE THE CONSTRUCTION FEATURES AND DIMENSIONS SHOWN IN PRODUCT SPECIFICATION SHEET AND/OR DRAWINGS AND WHERE THE INPUT RATING OF THE RETROFIT KIT DOES NOT EXCEED THE INPUT RATING OF THE LUMINAIRE.

“DO NOT MAKE OR ALTER ANY OPEN HOLES IN AN ENCLOSURE OF WIRING OR ELECTRICAL COMPONENTS DURING KIT INSTALLATION.”

THIS LAMP IS NOT INTENDED FOR USE WITH HID BALLAST OR EXTERNAL LED DRIVER. LAMP INSTALLATION WITH EXTERNAL DRIVER OR HID BALLAST VOIDS THE PRODUCT WARRANTY.

WARNING - TO PREVENT WIRING DAMAGE OR ABRASION, DO NOT EXPOSE WIRING TO EDGES OF SHEET METAL OR OTHER SHARP OBJECTS.

THIS DEVICE IS NOT INTENDED FOR USE WITH EMERGENCY EXITS or NOT FOR EMERGENCY LIGHTING.

CAUTION - DO NOT INSTALL THIS LAMP TO LINE VOLTAGE ABOVE 277VAC. THIS LAMP SUPPORTS 120VAC-277VAC VOLTAGE RANGE.

THIS DEVICE IS NOT INTENDED FOR USE WITH EMERGENCY EXITS or NOT FOR EMERGENCY LIGHTING.

For [SN-V-E39-L-20KLM-8XX-G3](#)

LUMINAIRE WITH DOME SHADE WITH OVERALL, MIN. 38 CM (15") DIAM. AT THE BOTTOM, TAPERING TO 16.5 CM (6.5") DIAM. ON TOP. MAX. 27.9 (11") CM DEPTH. (OPEN BOTTOM)

For [SN-V-E39-L-15KLM-8XX-G3](#), [SN-VS-E39-L-9KLM-8XX-G3](#), [SN-VS-E39-L-4.5KLM-8XX-G3](#)

LUMINAIRE WITH DOME SHADE WITH OVERALL, MIN. 38 CM (15") DIAM. AT THE BOTTOM, TAPERING TO 16.5 CM (6.5") DIAM. ON TOP. MAX. 36.8 CM (14.5") DEPTH. (CLOSE BOTTOM)

For [SN-V-E26-L-9KLM-8XX-G3](#), [SN-V-E26-L-4.5KLM-8XX-G3](#), [SN-VS-E26-L-4.5KLM-8XX-G3](#), [SN-VS-E26-L-4.5KLM-8XX-G3](#)

LUMINAIRE WITH DOME SHADE WITH OVERALL, MIN. 37.5 CM (14-1/4") DIAM. AT THE BOTTOM, TAPERING TO 26.7 CM (10.5") DIAM. ON TOP. MAX. 22.9 CM (9") DEPTH.