

**Dimmable LED and Dimmable CFL
Incandescent / Halogen 120V**

Single Pole or Three way

Model No.: 59302



Description: The 59302 dimmer switch is used for 120V Incandescent, Halogen, LED and CFL light bulbs. This dimmer is perfect to create the right ambiance within a room and save energy and cost.

Features:

- Provide a wide range of dimming, lighting fades up and down smoothly.
- Highly versatile, to meet a wide variety of applications.
- Designed for compatibility with most high efficacy light bulbs.
- Close-to-zero pre-adjustment setting to accommodate a wide range of bulbs.
- Switch returns load to previous level (pre-set Dimming Control).
- Longer mounting strap for more rigid installation, no more “floating”.

Specifications:

Voltage	120VAC, 60Hz
Incandescent/Halogen	700W
Dimmable LED and CFL.....	150W
Warranty	2 Years

WIRING DIAGRAM

Single-Pole Wiring

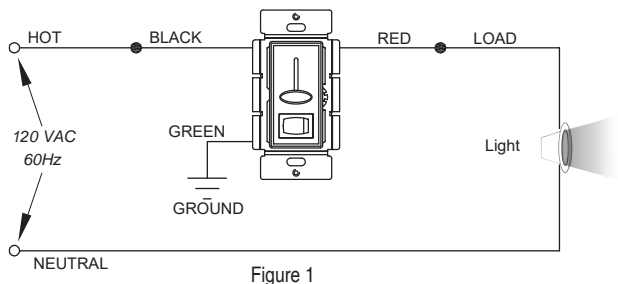

3-Way Wiring

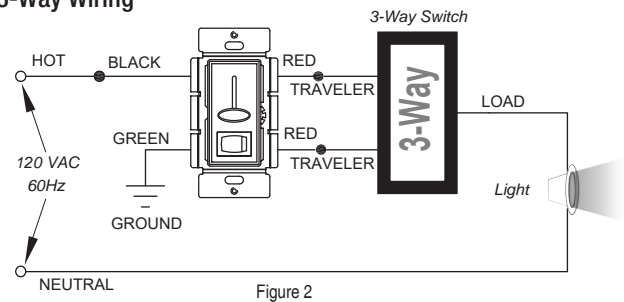

When using the 59302 Dimmer to control LED/CFL lights **in conjunction** with another 59302 Dimmer to control Incandescent /Halogen lights follow this Derating Chart for Maximum Capacity on **EACH** device.

If the combined Wattage of <u>ALL</u> LED/CFL bulbs on 1 dimmer is:	Then the Maximum COMBINED Wattaged for the Incandescent/Halogen bulbs on EACH attached dimmer:		
	If NO Tabs are removed then Max Wattage is:	If 1 side of Tabs are removed then Max Wattage is:	If 2 sides of Tabs are removed then Max Wattage is:
0W	700W	600W	500W
1-25W	500W	400W	300W
26-50W	400W	300W	200W
51-75W	300W	200W	100W
76-100W	200W	100W	50W
101-125W	100W	50W	0W
126-150W	0W	0W	0W

If you are using **ONLY** LED/CFL bulbs on **ALL** 59302 Dimmers, **DO NOT USE** this Derating Chart. Follow the LED/ CFL Derating Chart.

MULTIGANG INSTALLATION

When installing more than one control in the same wall box, it may be necessary to remove the side tabs before installing (see below). Using pliers, bend each tab back and forth until they break off. Repeat for each tab to be removed. Removal of tabs **WILL REDUCE MAXIMUM LOAD CAPACITY**.

LED/CFL Derating Chart			
	Load Capacity when Tabs are removed from:		
	0 Sides	1 Side	2 Sides
Dimmable LED/CFL	150W	150W	150W

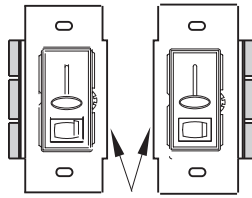

Tabs Removed for Multigang installation

DIMMER ADJUSTMENT

1. Power the lights on by using the Rocker switch and move the dimmer's slider down to the bottom.
2. Fine Tuning: To achieve the lowest light level, turn the Tuning dial Upwards/Downwards until desired level is reached. (Note: **DO NOT** overturn. The Dial will stop turning at lowest/ highest outputs).
3. To verify the setting, turn the dimmer off then back on.
4. Repeat step 2 if all bulbs do not turn on. Turn adjustment dial Up until all lights come on.
5. Some dimmable CFLs and LEDs require at least two light bulbs to be installed or 10 total wattage on one lamp for proper operation.

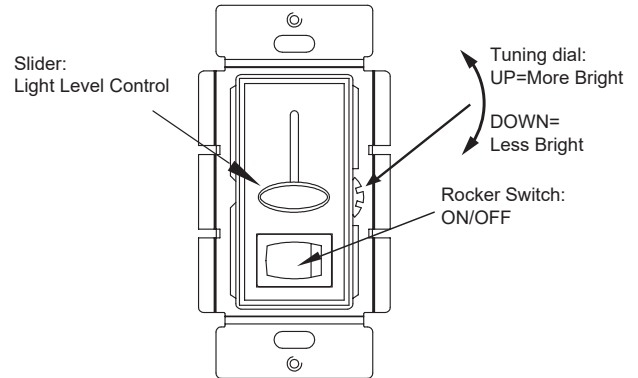

59302

120V Dimmer for Dimmable LED/ CFL
Incandescent / Halogen
(Single Pole/ 3-Way)

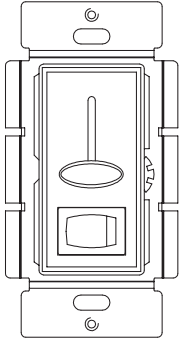

SPECIFICATIONS

Voltage	120VAC, 60Hz
Incandescent/ Halogen.....	700W
Dimmable LED and Dimmable CFL.....	150W
Operating Temperature.....	32°F-104°F

DESCRIPTION/ FEATURES

The 59302 is an Incandescent/Halogen and dimmable LED & CFL Dimmer. This Dimmer is designed to replace a standard light switch, dimmer, or a three-way lighting control (see 3-Way Wiring, Figure 2).

- Replaces current light switch using home's existing wiring
- Slide dimmer and rocker switch turns lights on to a preset level
- Provides wider dimming range for dimmable LED and CFL bulbs than standard incandescent dimmers
- Suitable for multi-gang installations
- Dim lighting for increased energy savings
- Adjustable sensitivity levels on the control slider.
- Designed for compatibility with most high efficiency light bulbs.

WARNING

Turn the POWER OFF at the circuit breaker before installing the Dimmer

Read and understand these instructions before installing. This device is intended for installation in accordance with the National Electric Code and local regulations. It is recommended that a qualified electrician performs this installation. Make sure to turn off the circuit breaker or fuse(s) and make sure power is off before wiring the device.

Use copper wire only

NOTES:

The dimmer can be used as a Single Pole or 3-way switch.
Only one dimmer is needed for each 3-way application.
For use with incandescent, halogen, dimmable CFL and LED lights.

WIRING DIRECTIONS

1. Connect the HOT wire to the BLACK wire on the switch
2. Connect the load wire to the uninsulated RED wire on the switch
 - a. If using switch as 3-way, remove insulating label from red wire and connect EACH RED wire to separate TRAVELER wires.
3. Connect GROUND wire to GREEN wire on the switch.
4. Mount the dimmer to the box with "UP" indicator pointing up.
5. Turn on Circuit Breaker

Single-Pole Wiring

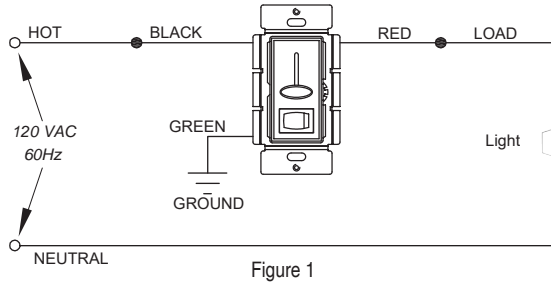

3-Way Wiring

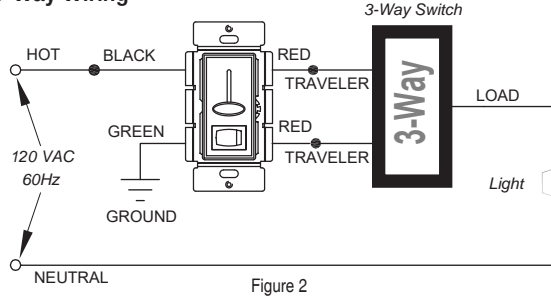

MULTIGANG INSTALLATION

When installing more than one control in the same wall box, it may be necessary to remove the side tabs before installing (see below). Using pliers, bend each tab back and forth until they break off. Repeat for each tab to be removed. Removal of tabs WILL REDUCE MAXIMUM LOAD CAPACITY.

LED/CFL Derating Chart			
Dimmable LED/CFL	Load Capacity when Tabs are removed from:		
	0 Sides	1 Side	2 Sides
Dimmable LED/CFL	150W	150W	150W

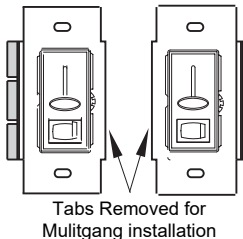

When using the 59302 Dimmer to control LED/CFL lights **in conjunction** with another 59302 Dimmer to control Incandescent /Halogen lights follow this Derating Chart for Maximum Capacity on EACH device.

If the combined Wattage of ALL LED/CFL bulbs on 1 dimmer is:	Then the Maximum COMBINED Wattaged for the Incandescent/Halogen bulbs on EACH attached dimmer:		
	If NO Tabs are removed then Max Wattage is:	If 1 side of Tabs are removed then Max Wattage is:	If 2 sides of Tabs are removed then Max Wattage is:
0W	700W	600W	500W
1-25W	500W	400W	300W
26-50W	400W	300W	200W
51-75W	300W	200W	100W
76-100W	200W	100W	50W
101-125W	100W	50W	0W
126-150W	0W	0W	0W

If you are using ONLY LED/CFL bulbs on ALL 59302 Dimmers, DO NOT USE this Derating Chart. Follow the LED/ CFL Derating Chart.

DIMMER ADJUSTMENT

1. Power the lights on by using the Rocker switch and move the dimmer's slider down to the bottom.
2. Fine Tuning: To achieve the lowest light level, turn the Tuning dial Upwards/ Downwards until desired level is reached. (Note: DO NOT overturn. The Dial will stop turning at lowest/ highest outputs).
3. To verify the setting, turn the dimmer off then back on. Repeat step 2 if all bulbs do not turn on.
4. Turn adjustment dial Up until all lights come on. Some dimmable CFLs and LEDs require at least two light bulbs to be installed or 10 total wattage on one lamp for proper operation.

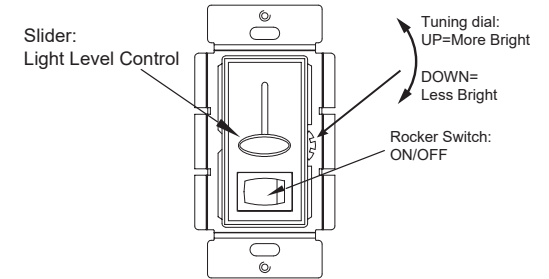

WARRANTY INFORMATION

This device is warranted to be free of material and workmanship defects for 2 years from the date of purchase. Original receipt or proof of purchase from an authorized retailer must be presented upon warranty claim. ALL claims must be verified and approved by Enerlites, Inc. Warranties from other Enerlites products may vary. This warranty is nontransferable and does not cover normal wear and tear or any malfunction, failure, or defect resulting from misuse, abuse, neglect, alteration, modification, or improper installation. To the fullest extent permitted by the applicable state law, Enerlites shall not be liable to the purchaser or end user customer of Enerlites products for direct, indirect, incidental, or consequential damages even if Enerlites has been advised of the possibility of such damages. Enerlites' total liability under this or any other warranty, express or implied, is limited to repair, replacement or refund. Repair, replacement or refund are the sole and exclusive remedies for breach of warranty or any other legal theory.

