

# LUNERA HID LED 360

## Installation Guide

Line Driven (UL Type B) / Mogul (E39) and Medium (E26) Base



### Product Description:

The LUNERA HID 360 LED lamp is a Line Driven (ballast bypassed) Mogul (E39) / Medium (E26) Base replacement of 70W-400W HID lamps.

Read this install guide carefully prior to lamp installation. Product SKU on the lamp must match one of the following SKUs:

Product SKU	Luminous Flux	Avg. Lamp Power	Base Type
SN-360-EYY-L-8KLM-8XX-G3	8,000lm	90W	Mogul (E39) / Medium (E26) Base
SN-360-EYY-L-5KLM-8XX-G3	5,000lm	53W	Mogul (E39) / Medium (E26) Base
SN-360-EYY-L-6KLM-820-G3	6,000lm	90W	Mogul (E39) / Medium (E26) Base
SN-360-EYY-L-3.5KLM-820-G3	3,500lm	53W	Mogul (E39) / Medium (E26) Base

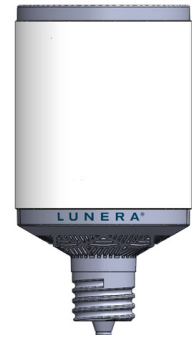

Mogul (E39) Base  
Up to 8,000lm

THIS LAMP IS NOT RATED FOR USE WITH HID BALLAST OR EXTERNAL LED DRIVER.

### Installation Instruction - Line Driven (120V-277V) Lamp

1. Turn power off to the fixture.
2. Remove existing HID lamp from the fixture.
3. Follow the steps below to bypass the existing HID ballasts (See Figure 1).
  - Step 1: Disconnect Line Voltage (Hot Wire) from the HID ballast as shown in Figure 1.
  - Step 2: Disconnect Neutral (COM) from the capacitor in the HID system.
  - Step 3: Disconnect the socket completely from the HID ballast.
  - Step 4: If the socket has a ground wire (Green) attached to the fixture; do not disconnect the ground wire.
  - Step 5: Connect Hot (120VAC-277VAC) to black wire; and Neutral to white wire connected to Mogul or Medium socket (See Figure 2).
  - Step 6: (For Mogul (E39) Base lamp Only) Attach the DarkSky accessory onto the Lunera HID LED 360 Lamp (See Figure 3).
4. Make sure the socket is not damaged.
5. Install the Lunera HID LED 360 Lamp.
6. Apply re-lamping label on a visible location inside the fixture.
7. Turn power on.



Medium (E26) Base  
Up to 8,000lm

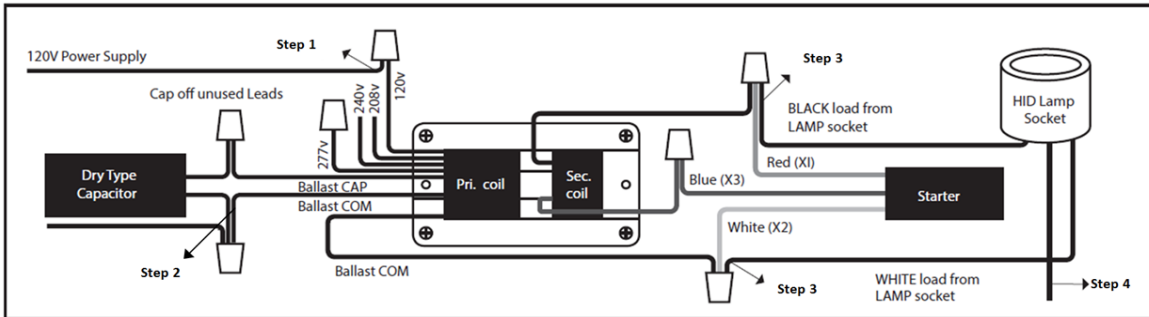

**Figure 1:** Bypassing the magnetic ballasts; follow steps 1 through 4 in the instructions above to bypass the HID ballast.

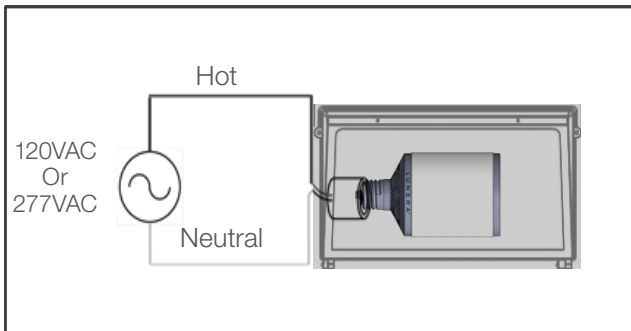



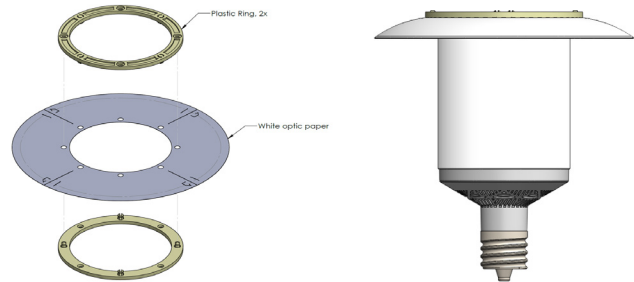



**Figure 2:** (Step 5) Bring Line Voltage to the Socket; Connect Hot to Black wire and Neutral to white wires connected to Mogul (E39) / Medium (E26) Base Socket.



**Figure 3:** (Step 6) Assemble the DarkSky accessory by placing the white optic film between two rings as shown above. Lock this piece onto the top of Lunera HID LED 360 Lamp.

### Intended Applications

The Lunera HID LED 360 lamp is designed to replace Metal Halide (MH) and High Pressure Sodium (HPS) lamps in the following compatible applications:

Wattage Compatibilities	Sockets	Power Source	Mount
<b>HID LED 360</b> Mogul (E39) Base <b>Replaces</b>  = 400W -70W MH or HPS	E39 / EX39 Mogul 	120V-277V Line Voltage 	360° Illumination Vertical / Horizontal
<b>HID LED 360</b> Medium (E26) Base  = 400W -70W MH or HPS	E26 Medium 		<b>Fixture Type</b>  Architectural Post Top

## General Safety Information

### READ AND FOLLOW ALL SAFETY INSTRUCTIONS

**WARNING -** RISK OF FIRE OR ELECTRIC SHOCK. LED RETROFIT KIT INSTALLATION REQUIRES KNOWLEDGE OF LUMINAIRE ELECTRICAL SYSTEM. IF NOT QUALIFIED, DO NOT ATTEMPT INSTALLATION. CONTACT A QUALIFIED ELECTRICIAN.

**WARNING -** IF THE LAMP OR LUMINAIRE EXHIBITS UNDESIRABLE OPERATION (BUZZING, FLICKERING, ETC) IMMEDIATELY TURN OFF POWER, REMOVE LAMP FROM LUMINAIRE AND CONTACT MANUFACTURER.

**WARNING -** RISK OF FIRE OR ELECTRIC SHOCK. INSTALL THIS KIT ONLY IN LUMINAIRE THAT HAVE THE CONSTRUCTION FEATURES AND DIMENSIONS SHOWN IN PRODUCT SPECIFICATION SHEET AND/OR DRAWINGS AND WHERE THE INPUT RATING OF THE RETROFIT KIT DOES NOT EXCEED THE INPUT RATING OF THE LUMINAIRE.

“DO NOT MAKE OR ALTER ANY OPEN HOLES IN AN ENCLOSURE OF WIRING OR ELECTRICAL COMPONENTS DURING KIT INSTALLATION.”

THIS LAMP IS NOT INTENDED FOR USE WITH HID BALLAST OR EXTERNAL LED DRIVER. LAMP INSTALLATION WITH EXTERNAL DRIVER OR HID BALLAST

VOIDS THE PRODUCT WARRANTY. TO PREVENT WIRING DAMAGE OR ABRASION, DO NOT EXPOSE WIRING TO EDGES OF SHEET METAL OR OTHER SHARP OBJECTS.

**CAUTION -** DO NOT INSTALL THIS LAMP TO LINE VOLTAGE ABOVE 277VAC. THIS LAMP SUPPORTS 120VAC-277VAC VOLTAGE RANGE.

THIS DEVICE IS NOT INTENDED FOR USE WITH EMERGENCY EXITS or NOT FOR EMERGENCY LIGHTING.

MIN. LAMP COMPARTMENT DIMENSIONS; MIN. 20.3 CM (8") DDIA. AT THE BOTTOM, 20.3 CM (8") DIAM. ON TOP. MAX. 40.6 CM (16") DEPTH.

