

## MPC-50H

High Bay 360° Passive Infrared Line Voltage Occupancy Sensor

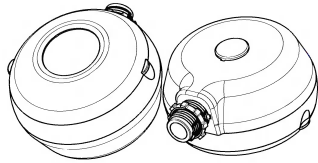

### SPECIFICATIONS

Voltage .....	120/277VAC, 50/60Hz
Load Requirements:	
@ 120VAC, .....	0-800W ballast or tungsten
@ 277VAC, .....	0-1200W ballast
@ 120VAC .....	1/4 hp
Adjustable Light Level.....	10FC—150FC
Adjustable Sensitivity.....	50% or 100%(DIP switch)
Coverage:	
MPC-50H-L1: Mounting height: 50ft	Field of view: 360° Coverage :2800 sq.ft
MPC-50H-L2: Mounting height: 8ft	Field of view: 360° Coverage :1200 sq.ft
Operating Temperature .....	32°to 131°F (0°to 55°C)
Relative Humidity .....	20-90%, non-condensing
Material.....	ABS

### DESCRIPTION

The MPC-50H 360° occupancy sensor uses advanced PIR technology to turn on the lights when motion is detected and keep the lights on when movement is present. The sensor will automatically turn off the lights if no movement is detected within the amount of time selected in the time delay.

The MPC-50H is specially designed for use in areas with high ceilings such as warehouses, distribution centers, and gymnasiums. Be sure to attach the appropriate lens based on the ceiling height.

There are two lens choices available, lens 1 and lens 2. Lens 1 is an extended range lens that provides up to 2800 sq. ft. of coverage at a maximum installation height of 50 ft.

Lens 2 is a high density lens that provides up to 1200 sq. ft. of coverage at a maximum installation height of 8 ft.

### COVERAGE

#### Lens choices:

The coverage area is determined by the type of lens attached to the MPC-50H. (See Figure 1).

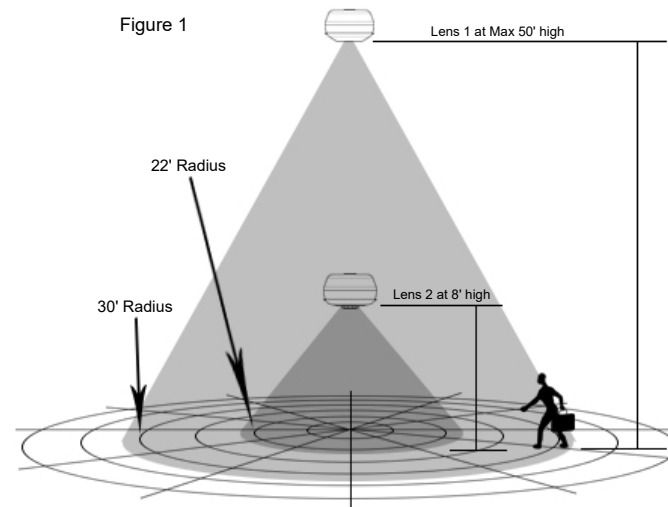
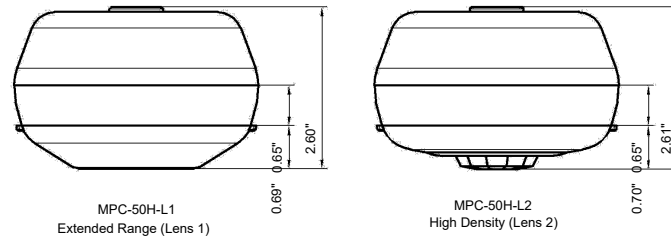

### WARNING

**Turn the POWER OFF at the circuit breaker before installing the sensor**

Read and understand these instructions before installing. This device is intended for installation in accordance with the National Electric Code and local regulations. It is recommended that a qualified electrician performs this installation. Make sure to turn off the circuit breaker or fuse(s) and make sure power is off before wiring the device. Use copper wire only, or equivalent.

### WIRING DIRECTIONS

Refer to the wire diagram of the sensor (See Figure 2)

1. Connect the hot wire to the black wire on the sensor
2. Connect the neutral wire to the white wire on the sensor
3. Connect the load wire to the red wire on the sensor
4. If using provided Housing, attach by aligning the arrow on the MPC-50H with the *Open* arrow on the Housing, then twist the device counterclockwise until the *Close* arrows align.
5. Turn on Circuit Breaker

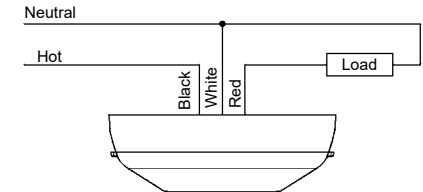

Figure 2  
MPC-50H

### LIGHT LEVEL ADJUSTMENT

The sensor may be adjusted to operate at the desired level of light under normal lighting conditions of the immediate area.

To do so, turn the dial to point the arrow toward the “-” sign for sensor to detect motion and operate during low light or no light. Point the arrow toward the “+” sign for sensor to operate when there’s more light in the area or even during daylight.

NOTE: The light level is adjustable only when the time delay is set at or above 30 seconds.

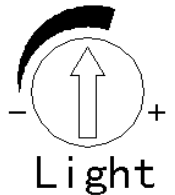

### SENSOR ADJUSTMENT

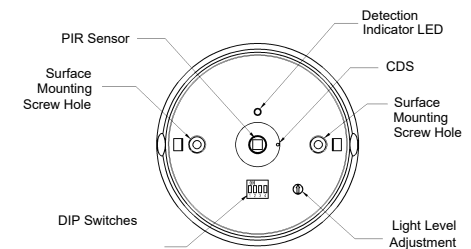

**Note: The LED indicator flashes during the 60-second warm-up period when power is first applied**

- If the sensor detects occupancy during the warm-up, the time delay will increase.
- If no occupancy is detected during the warm-up, the light turns OFF after the initial 60-second warm-up period.

# INSTALLATION

The MPC-50H can be directly attached to the fixture or ceiling (See Figure 3 below), or attached to the fixture or junction box with the provided housing (See Figure 4 below).

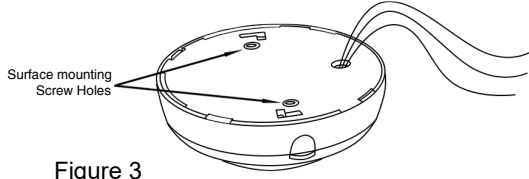

Figure 3

## Mounting the Housing

The Housing comes ready to install on the side of a fixture or junction box.

To mount the Housing on the surface of the fixture or ceiling, twist off the lock nut on the connector and remove the connector. Then install it on the back of the Housing and cover the side knockout with the knockout cover.

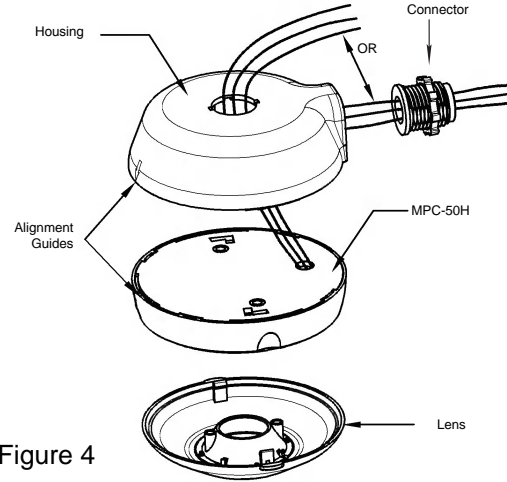

Figure 4

# TESTING OCCUPANCY SENSOR

Note: There is a 40- second warm-up period when power is first applied. Use a small screwdriver to open the front cover and make changes to the settings. The pre-set time delay is Test mode and light level is set at maximum

Refer to Figure 3 on previous page.

1. Ensure the PIR Activity is enabled, red LED flashes, and PIR Sensitivity is set to 100% (DIP switch 1 OFF).
2. Ensure the Time Delay is set for Test Mode.
3. Ensure that the Light Level is at the maximum position.(see" LIGHT LEVEL ADJUSTMENT").
4. Remain still. The red LED should not flash. The lights should turn off after 15 seconds. (If not, see "TROUBLESHOOTING.")
5. Move in the front of coverage area. The lights should turn on automatically. When functional test is complete, set DIP Switches, Time Delay and Light Level to the desired settings, and put the front cover back on the sensor.

## DIP SWITCH SETTING

The MPC-50H has 4 DIP switches under the lens cover. They are used to set the sensitivity and time delay. This device is factory preset for quick installation and is ready to test once installed. After testing, adjust the DIP switches and Light dial to desired levels.

Sensitivity	1
100%	↑
50%	↓

◀ Factory setting  
↓ =OFF ↑ =ON

Time Delay	2	3	4
Test/15 Seconds	↓	↓	↓
5 Minutes	↓	↓	↓
10 Minutes	↓	↓	↓
15 Minutes	↓	↓	↓
20 Minutes	↑	↑	↑
25 Minutes	↑	↑	↑
30 Minutes	↑	↑	↑

### Sensitivity setting: DIP switch 1

**50%** -This setting will decrease the amount of area the sensor will cover to half the range of the installed lens.

**100%** -This setting will allow the sensor to utilize the maximum range the installed lens can cover.

Maximum range of MPC-50H-L1 coverage is 2800 square feet. Maximum range of MPC-50H-L2 coverage is 1200 sq. ft.

### Time delay: DIP switch 2,3,4

The time delay is set with Dip switches 2, 3 and 4, from 15 seconds to 30 minutes. When there is no movement detected by sensor, the lights will automatically turn off after the selected time delay has expired.

# TROUBLESHOOTING

**Warning: Turn the POWER OFF at the circuit breaker before installing.**

## LED does not blink:

1. Make sure the sensor has power.
2. Check the location of the sensor and verify that the sensor can detect motion from human body. If not , the LED will not blink.
3. Check the wire connections and verify that the wires are secured with wire caps.

## LED blinks but lights do not turn ON:

1. Check the "Light" setting. If the arrow is pointed to the "-"position, the area needs to be dark enough for the sensor to operate. Cover the light sensor lens to simulate darkness. If the light turns ON, the light level setting needs to be adjusted.
2. Make sure the wires are connected and bulbs are working.
3. Check for obstructions in the lens cover.
4. Make sure that power to the sensor has been ON continuously for at least one minute. Wait for the warm-up period to end, and if LED flashes, the load has not turn on, then go to next step.

## Lights do not turn OFF automatically:

1. If there is no motion from people or equipment in the sensor's view but the LED blinks, look for any nearby source of infrared energy (heat) in motion, such as turbulent air from a heating or cooling supply.
  - Mount the sensor so that it's lens is below the edge of the fixture and does not directly view the lamps.
  - Move the air supply away from the sensor, or move the sensor.
2. Verify the time delay settings in switches 2-4. The time delay can be set from 15 seconds to 30 minutes. Ensure that the time delay is set to the desired delay and that there is no movement within the sensor's view for that time period.
3. Check sensor wire connections, verify load and neutral wires are secure.

# WARRANTY INFORMATION

This device is warranted to be free of material and workmanship defects for 2 years from the date of purchase. Original receipt or proof of purchase from an authorized retailer must be presented upon warranty claim. ALL claims must be verified and approved by Enerlites, Inc. Warranties from other Enerlites products may vary. This warranty is nontransferable and does not cover normal wear and tear or any malfunction, failure, or defect resulting from misuse, abuse, neglect, alteration, modification, or improper installation. To the fullest extent permitted by the applicable state law, Enerlites shall not be liable to the purchaser or end user customer of Enerlites products for direct, indirect, incidental, or consequential damages even if Enerlites has been advised of the possibility of such damages. Enerlites' total liability under this or any other warranty, express or implied, is limited to repair, replacement or refund. Repair, replacement or refund are the sole and exclusive remedies for breach of warranty or any other legal theory.

