

H TRACK

120V Single Circuit Track System

WAC LIGHTING

Responsible Lighting®

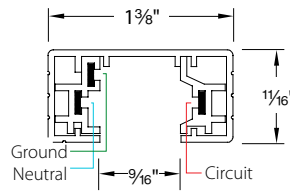

PRODUCT DESCRIPTION

Designed for nearly every application and interior environment, our extensive 120V Track collection offers hundreds of luminaires that integrate cutting edge design and aerospace detailing with designer glass and metal finishes. Versatile yet sturdy, the track systems can be surface mounted or suspended from the ceiling, liberating luminaires from the constraints of rigid mountings and enabling the lighting design to adapt to changing styles and spaces.

FEATURES

- May be field cut and easily installed on a variety of surfaces
- Available extension accessories
- Use compatible Quick Connect™ pendants and fixtures with each system
- End caps and mounting hardware included
- Retrofits into many popular track systems on the market today.

SPECIFICATIONS

Materials: Aluminum extrusion with copper bus wire.

Electrical: 20 Amps rated, 120V. It is common practice to use tracks at 80% capacity to insure compatibility with dimmers and connectors (1920W maximum).

Mounting: Can be installed on drywall, or suspended ceilings.

Standards: UL & CUL listed

Selecting Connectors (example using H Track)

• In order to select the appropriate connectors to maintain electrical continuity, start at your power source and walk the length of the track. If you turn left, use a left connector. If you turn right, use a right connector.

Polarity is just a matter of matching ends
The 2 wire side of an "H" Track has an indicator groove running its length

- Using a left connector, the track would run with the groove along the outside
- Using a right connector, the track would run with the groove along the inside

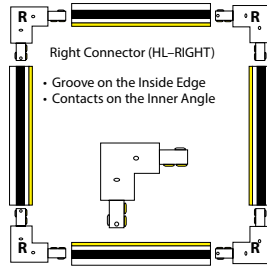
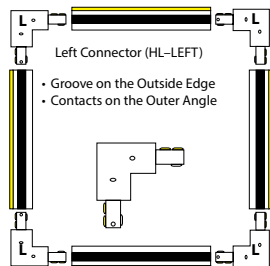

■ = Electrical Continuity

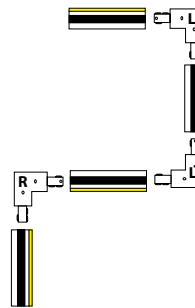

ORDER NUMBER

Model	Length	Finish
HT H Track	2 2'	BK Black
	4 4'	BN Brushed Nickel
	6 6'	WT White
	8 8'	DB Dark Bronze

Each section includes two matching end caps.



Example: **HT6-DB**

Sample Layout

- A **SK18** 18" Track suspension rod
- B **HLE** Live end connector
- C **HT2** 2 foot Section of H Track
- D **HL-LEFT** "H" Connector (Left)
- E **H-LED175-27** LEDme™ LED track head
- F **H-ENDCAP** End Cap (included with track section)

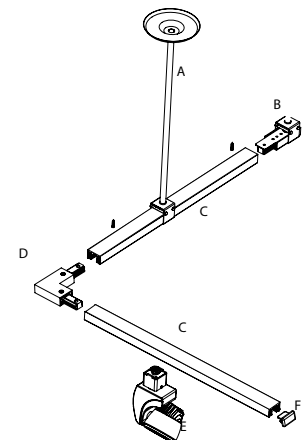

























H TRACK

120V Single Circuit Track System

WAC LIGHTING

Responsible Lighting®

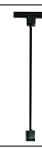
Accessories				Adapters			
Model	Finish	Description	Model	Finish	Description		
Live End Connector		HLE BK BN WT DB 4 1/4" x 1 3/8" x 3/4"	Use for direct wiring through ceiling. A canopy plate is required when using with a standard junction box.	Quick Connect™ Adapter		EN-HQ50AR BK BN WT DB	Connects pendant or fixture to track.
Live End BX Connector		HBXLE BK BN WT DB 6" x 1 3/8" x 1 1/4"	Use with surface mounted BX or non-metallic sheathed cable. Also provides through the ceiling connection.	Monopoint Canopy Adapter		HMP Ø 4 3/4"	Mount a single H, L or J system track fixture to a junction box. When used with a low voltage track head the transformer box will protrude off of the face of the monopoint.
"I" Power Connector		HI-PWR BK BN WT DB 6 3/4" x 1 3/8" x 3/4"	Power entry point at the connection of 2 tracks.	"L" Connector Left		HL-LEFT BK BN WT DB 2 3/4" x 2 3/4" x 3/4"	Use to join 2 track sections to make power feedable 90° left polarity turns.
"L" Connector Right		HL-RIGHT					
"T" Connector		HT BK BN WT DB 4" x 2 3/4" x 3/4"	Use to join 3 track sections. Power feedable on H and J only. "T" Connector with opposite polarity can be custom ordered.				
"X" Connector		HX BK BN WT DB 4 1/8" x 4 1/8" x 3/4"	Use to join 4 track sections. Power feedable on H and J only.	"I" Connector		HI BK BN WT DB 3" x 1 3/8" x 3/4"	Use to join two sections of track with electrical continuity.
"I" Dead End Connector		HI-DEC BK BN WT DB 3" x 1 3/8" x 3/4"	Joins two sections of track without electrical continuity.				
Flexible Track Connector		HFLX BK BN WT DB 11" x 1 3/8" x 3/4"	Connects two track sections at variable angles. Use as a transition from wall-to-wall, wall-to-ceiling, or ceiling-to-ceiling. Power feedable.	Suspension Loop		H-LOOP BK BN WT DB 1 3/8" x 1 3/8" x 3"	3 inch electrical loop accepts chain hung fixtures up to 35lbs. Contains compartment for electrical connections.
15' Cord, Male Plug		HCORD BK WT 15'	Maximum capacity: 7A, 800W, 120V.				
T-Bar Drop Ceiling Attach		T-BARCLIP 1 1/2" x 1 1/4"	Attaches track to T-bar drop ceilings. Use two for 2 foot or 4 foot tracks, three for 6 foot or 8 foot tracks.	Canopy Plate		CP BK BN WT DB 4 1/2" x 4 1/2"	Covers a standard 4 inch junction box. Use with any powerable connectors.
Floating Canopy Connector		HFC BK BN WT DB 4 1/2" x 4 1/2" x 1 1/2"	Connects to octagon box. Allows track to be powered anywhere along the length of the track.				

Track Suspension			
Model	Finish	Description	
All Track Suspension Kit		SK 18 18" 24 24" 36 36" 48 48" BK BN WT DB	Extends track from ceiling. Includes track bracket, rod and ceiling canopy.
Suspension Kit Extender		R 18 18" 24 24" 36 36" 48 48" 72 72" BK BN WT DB	Use with Rod Coupler (RI) to further extend track from ceiling.
Sloped Ceiling Adapter		SK14 BK BN WT DB	Use with suspension kits for sloped ceilings
Rod Coupler		RI BK BN WT DB	Join two rods for suspensions longer than 48".
Suspension Adjustment Collar kit		SK05 BK BN WT DB	Used when suspension rod is field cut to custom lengths. One kit of two required for each rod.
Low Voltage Track Head Extension		X 6 6" 12 12" 18 18" 24 24" 36 36" 48 48" BK BN WT DB	Extends low voltage track heads from track. Only available as complete unit.
Line Voltage Track Head Extension		H 18 18" 24 24" 36 36" 48 48" BK BN WT DB	Extends H System line voltage track heads.
Wall Mount Suspension Bracket		TBKT 18" BK BN WT DB	Extends track 24" from wall. Use two per 4' length, three per 8' length.

H TRACK CURRENT LIMITER

120V Track System

WAC LIGHTING

Responsible Lighting®





Low Cost Energy Code Compliance Made Easy

- Easy to install and assures compliance to California Title 24 or ASHRAE 90.1 requirements
- Energy code track installations are subject to wattage limitations based upon the size and usage of the space
- To order appropriate current limiter, select the model number which corresponds to the H system to the maximum allowable wattage
- May be mounted as a standard canopy, used in place of an "I" connector or as a live-end

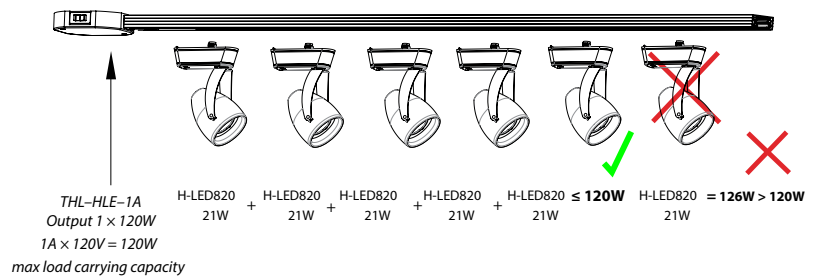
How It Works

- If the track is overloaded the current limiter circuit breaker will trip and shut down power to the track.
- May be reset when the overall sum of fixture wattages are reduced below the circuit breaker rating
- It's that easy to ensure energy efficient usage of track installations.



Model	H Track	Circuit Breaker	Max Wattage	Finishes	Dimensions	
Single Live End		THL-HLE-1A	1 × 1A	1 × 120W	BK Black BN Brushed Nickel DB Dark Bronze WT White	7½" × 5" × 1¼"
	THL-HLE-2A	1 × 2.5A	1 × 300W			
	THL-HLE-5A	1 × 5A	1 × 600W			
	THL-HLE-7A	1 × 7.5A	1 × 900W			
	THL-HLE-10A	1 × 10A	1 × 1200W			
Double Live End		THL-HI-1-1A	1 × 1A	1 × 120W		
		THL-HI-2-1A	2 × 1A	2 × 120W		
		THL-HI-1-2A	1 × 2.5A	1 × 300W		
		THL-HI-2-2A	2 × 2.5A	2 × 300W		
		THL-HI-1-5A	1 × 5A	1 × 600W		
		THL-HI-2-5A	2 × 5A	2 × 600W		
		THL-HI-1-7A	1 × 7.5A	1 × 900W		
		THL-HI-2-7A	2 × 7.5A	2 × 900W		
		THL-HI-1-10A	1 × 10A	1 × 1200W		
		THL-HI-2-10A	2 × 10A	2 × 1200W		
Double Live End (Left)		THL-LEFT-1-1A	1 × 1A	1 × 120W		
		THL-LEFT-2-1A	2 × 1A	2 × 120W		
		THL-LEFT-1-2A	1 × 2.5A	1 × 300W		
		THL-LEFT-2-2A	2 × 2.5A	2 × 300W		
		THL-LEFT-1-5A	1 × 5A	1 × 600W		
		THL-LEFT-2-5A	2 × 5A	2 × 600W		
		THL-LEFT-1-7A	1 × 7.5A	1 × 900W		
		THL-LEFT-2-7A	2 × 7.5A	2 × 900W		
		THL-LEFT-1-10A	1 × 10A	1 × 1200W		
		THL-LEFT-2-10A	2 × 10A	2 × 1200W		
Double Live End (Right)		THL-RIGHT-1-1A	1 × 1A	1 × 120W		
		THL-RIGHT-2-1A	2 × 1A	2 × 120W		
		THL-RIGHT-1-2A	1 × 2.5A	1 × 300W		
		THL-RIGHT-2-2A	2 × 2.5A	2 × 300W		
		THL-RIGHT-1-5A	1 × 5A	1 × 600W		
		THL-RIGHT-2-5A	2 × 5A	2 × 600W		
		THL-RIGHT-1-7A	1 × 7.5A	1 × 900W		
		THL-RIGHT-2-7A	2 × 7.5A	2 × 900W		
		THL-RIGHT-1-10A	1 × 10A	1 × 1200W		
		THL-RIGHT-2-10A	2 × 10A	2 × 1200W		

Example: **THL-LEFT-1-1A-WT**