

LED TROFFER FIXTURE



2' X 2'



2' X 4'

This Led Troffer fixture adopts the latest in optical and LED technology, maximizes vales as an energy efficient alternative to recessed T8 fluorescent fixture.

Fully assembly fixtures looks seamless and creates the impression of solid construction after installation.

Comfortable and evenly distributed light eliminates shadows and ensure glare-free ambiance.

The fixture is perfect for office, school, hospital and any commercial applications .

Specification:

- Available in 2'*2' 35W and 2'*4' 42W for recessed installation.
- Built-in earthquake clips for safety.
- Fites into 5/8 th,3/8 th and slot T standard T-bar sizes.
- Frosted extruded acrylic lens delivers comfortable and even light.
- White powder coated steel housing improves the efficacy of the fixtures.
- High quality constant –current driver rated for 50 to 60Hz at 120-277V input.
- 1-10V Dimmable.
- 50,000 hours rated life.
- 80+ CRI provides quality and consistent color rendering.
- Available in multiple CCTS :3500K,4000K and 5000K.
- NO Mercury ,Rohs Compliant.
- UL and cUL listed for dry locations ,DLC qualified.
- Fixtures can be shipped pre-installed with emergency power pack.

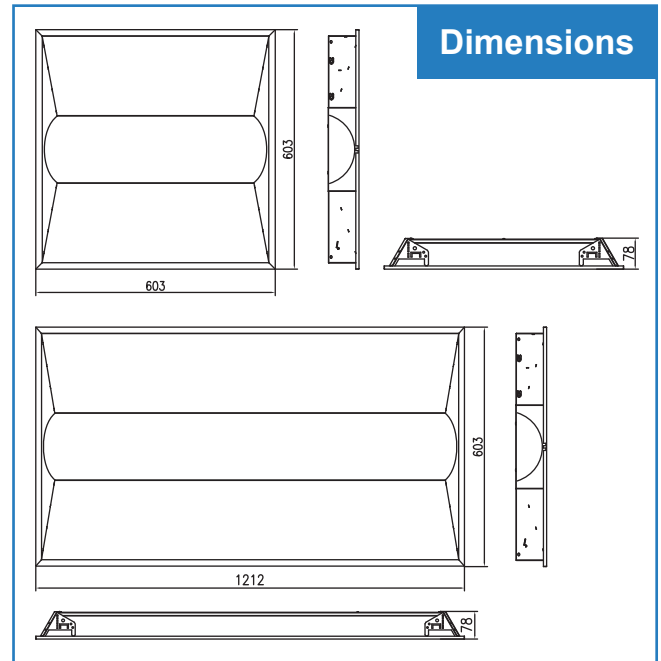

ORDERING GUIDE Example: 22TR35W35KUNV10VEMB

Fixture Size	Watts	CCT	Voltage	Control	Options
22TR	35W	35K	UNV	10V	EMB
22TR 2' X 2'	35W 35W, 3150 Lumens-90 LPW	35K 3500K 40K 4000K	UNV 120-277 Volt	10V 1-10V Dimming 10%	EMB Emergency Battery Backup
24TR 2' X 4'	42W 42W, 4200 Lumens-100 LPW	50K 5000K			

PERFORMANCE INFORMATION

Fixture Size	Watt	Product Code	Voltage	CCT	CRI	Lumen Output	Useful Life*	Beam Spread	Dimmable
2' X 2'	35	22TR35W35KUNV10V	120-277V	35K	82	3150	50000	120 °	1-10V
	35	22TR35W40KUNV10V	120-277V	40K	82	3150	50000	120 °	1-10V
	35	22TR35W50KUNV10V	120-277V	50K	82	3150	50000	120 °	1-10V
2' X 4'	42	24TR42W35KUNV10V	120-277V	35K	82	4200	50000	120 °	1-10V
	42	24TR42W40KUNV10V	120-277V	40K	82	4200	50000	120 °	1-10V
	42	24TR42W50KUNV10V	120-277V	50K	82	4200	50000	120 °	1-10V

PHOTOMETRY DATA

22TR35W40KUNV10V

WATTAGE: 35W

LUMENS: 3150

TOTAL LUMINAIRE EFFICACY: 90

Candle Power Distribution (Candelas)

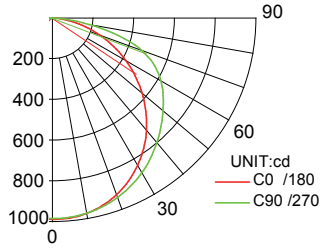

AVERAGE BEAM ANGLE(50%):123.9 DEG

Spacing Criteria

0-180 : 1.23
90-270 : 1.33

EFFICACY: 90LM/W

Zonal Lumens Summary

Y	φ zone	φ t ot al	%
0- 10	93.32	93.32	2.99
10- 20	268.5	361.8	11.61
20- 30	410.7	772.6	24.78
30- 40	502.8	1275	40.91
40- 50	535.3	1811	58.08
50- 60	511.6	2322	74.49
60- 70	437.5	2760	88.53
70- 80	287.4	3047	97.75
80- 90	67.01	3114	99.90
90- 100	0.2694	3114	99.91
100- 110	0.3548	3115	99.92
110- 120	0.4435	3115	99.93
120- 130	0.5087	3116	99.95
130- 140	0.5093	3116	99.96
140- 150	0.4694	3117	99.98
150- 160	0.3685	3117	99.99
160- 170	0.2281	3117	100.00
170- 180	0.0677	3117	100.00

Luminance Data (cd/sq.m)

G(DEG)	C0/180	C90/270
85	744	1990
80	1356	3173
75	1708	3767
70	1933	3846
65	2086	3642
60	2205	3415
55	2298	3209
50	2382	3061
45	2454	2960

Candela Tabulation

Y	C0	C45	C90
10	965.2	967.3	972.8
20	906.5	918.7	936.4
30	814.6	841.3	877.1
40	693.8	739.1	796.9
50	551.1	618.7	708.2
60	397.0	495.0	614.8
70	238.1	369.1	473.5
80	84.75	184.6	198.4
90	0.1809	0.2464	0.4796

Coefficients of Utilization - Zonal Cavity Method

Effective Floor Cavity Reflectance 20% = PF

Pcc	80%			70%			50%			30%			10%			0
Pw	50%	30%	10%	50%	30%	10%	50%	30%	10%	50%	30%	10%	50%	30%	10%	0
Pfc	20%															0
RCR	RCR:Room Cavity Ratio						Coefficients of Utilization(CU)									
0.0	1.19	1.19	1.19	1.16	1.16	1.16	1.11	1.11	1.11	1.06	1.06	1.06	1.02	1.02	1.02	.00
1.0	1.03	.98	.94	1.01	.96	.93	.96	.93	.90	.92	.89	.87	.89	.86	.84	.82
2.0	.89	.82	.75	.87	.80	.74	.83	.78	.73	.80	.75	.71	.77	.73	.69	.67
3.0	.77	.69	.62	.76	.68	.61	.73	.66	.60	.70	.64	.59	.67	.62	.58	.56
4.0	.68	.59	.52	.67	.58	.52	.64	.57	.51	.62	.55	.50	.60	.54	.49	.47
5.0	.61	.51	.44	.59	.51	.44	.57	.50	.44	.55	.48	.43	.53	.47	.43	.40
6.0	.54	.45	.38	.53	.45	.38	.52	.44	.38	.50	.43	.38	.48	.42	.37	.35
7.0	.49	.40	.34	.48	.40	.34	.47	.39	.33	.45	.38	.33	.44	.38	.33	.31
8.0	.45	.36	.30	.44	.36	.30	.43	.35	.30	.41	.35	.30	.40	.34	.29	.27
9.0	.41	.33	.27	.40	.32	.27	.39	.32	.27	.38	.31	.27	.37	.31	.26	.25
10.0	.38	.30	.24	.37	.30	.24	.36	.29	.24	.35	.29	.24	.34	.28	.24	.22

RC - Ceiling Cavity Reflectance

RW - Wall Reflectance

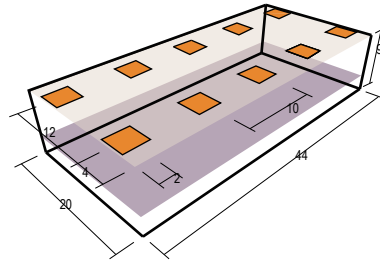

Results

20' Width X 44' Length X 9' Height		2.5' WORKPLANE, LLF: 0.9			
Spacing	Average FC	No. of Luminaires	(LPD) w/ft2	Avg/Min	Max/Min
8' X 8'	54.11	12	0.443	1.90	2.69
8' X 10'	53.03	12	0.443	1.55	2.13
10' X 10'	39.58	10	0.443	1.50	2.43
10' X 10'	38.31	10	0.443	1.36	2.26

24TR42W40KUNV10V

WATTAGE: 42W

LUMENS: 4200

TOTAL LUMINAIRE EFFICACY: 100

Candle Power Distribution (Candelas)

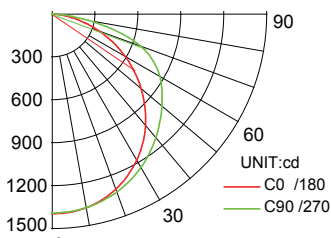

AVERAGE BEAM ANGLE(50%):123.9 DEG

Spacing Criteria

0-180 : 1.34
90-270 : 1.24

EFFICACY: 100LM/W

Zonal Lumens Summary

Y	φ zone	φ t ot al	%
0- 10	131.7	131.7	2.99
10- 20	378.9	510.6	11.61
20- 30	579.6	1090	24.78
30- 40	709.5	1800	40.91
40- 50	755.5	2555	58.08
50- 60	721.9	3277	74.49
60- 70	617.4	3895	88.53
70- 80	405.6	4300	97.75
80- 90	94.56	4395	99.90
90- 100	0.3802	4395	99.91
100- 110	0.5007	4396	99.92
110- 120	0.6258	4396	99.93
120- 130	0.7179	4397	99.95
130- 140	0.7187	4398	99.96
140- 150	0.6624	4398	99.98
150- 160	0.5200	4399	99.99
160- 170	0.3219	4399	100.00
170- 180	0.0955	4399	100.00

Luminance Data (cd/sq.m)

G(DEG)	C0/180	C90/270
85	525	1404
80	957	2239
75	1205	2658
70	1364	2714
65	1472	2570
60	1556	2410
55	1621	2265
50	1681	2159
45	1731	2088

Candela Tabulation

Y	C0	C45	C90
10	1362	1365	1373
20	1279	1296	1321
30	1150	1187	1238
40	979.1	1043	1125
50	777.8	873.2	999.4
60	560.2	698.6	867.6
70	335.9	520.9	668.3
80	119.6	260.4	279.9
90	0.2553	0.3477	0.6768

Coefficients of Utilization - Zonal Cavity Method

Effective Floor Cavity Reflectance 20% = PF

Pcc	80%			70%			50%			30%			10%			0
Pw	50%	30%	10%	50%	30%	10%	50%	30%	10%	50%	30%	10%	50%	30%	10%	0
Pfc	20%															0
RCR	RCR:Room Cavity Ratio						Coefficients of Utilization(CU)									
0.0	1.19	1.19	1.19	1.16	1.16	1.16	1.11	1.11	1.11	1.06	1.06	1.06	1.02	1.02	1.02	.00
1.0	1.03	.98	.94	1.01	.96	.93	.96	.93	.90	.92	.89	.87	.89	.86	.84	.82
2.0	.89	.82	.75	.87	.80	.74	.83	.78	.73	.80	.75	.71	.77	.73	.69	.67
3.0	.77	.69	.62	.76	.68	.61	.73	.66	.60	.70	.64	.59	.67	.62	.58	.56
4.0	.68	.59	.52	.67	.58	.52	.64	.57	.51	.62	.55	.50	.60	.54	.49	.47
5.0	.61	.51	.44	.59	.51	.44	.57	.50	.44	.55	.48	.43	.53	.47	.43	.40
6.0	.54	.45	.38	.53	.45	.38	.52	.44	.38	.50	.43	.38	.48	.42	.37	.35
7.0	.49	.40	.34	.48	.40	.34	.47	.39	.33	.45	.38	.33	.44	.38	.33	.31
8.0	.45	.36	.30	.44	.36	.30	.43	.35	.30	.41	.35	.30	.40	.34	.29	.27
9.0	.41	.33	.27	.40	.32	.27	.39	.32	.27	.38	.31	.27	.37	.31	.26	.25
10.0	.38	.30	.24	.37	.30	.24	.36	.29	.24	.35	.29	.24	.34	.28	.24	.22

RC - Ceiling Cavity Reflectance

RW - Wall Reflectance

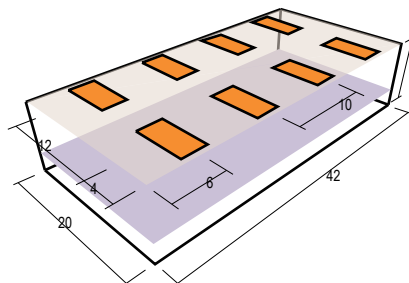

Results

20' Width X 42' Length X 9' Height		2.5' WORKPLANE, LLF: 0.9			
Spacing	Average FC	No. of Luminaires	(LPD) w/ft2	Avg/Min	Max/Min
8' X 8'	67.57	10	0.506	1.71	2.31
8' X 10'	66.89	10	0.506	1.42	1.90
10' X 10'	57.80	8	0.506	1.55	2.13
10' X 10'	55.57	8	0.506	1.45	2.05