

INSTALLATION INSTRUCTIONS

WARNINGS AND CAUTIONS

- **TO AVOID FIRE, SHOCK, OR DEATH; TURN OFF POWER** at circuit breaker or fuse and test that power is off before wiring!
- **TO AVOID FIRE, PERSONAL INJURY OR PROPERTY DAMAGE, DO NOT** install to control a receptacle.
- To be installed and/or used in accordance with electrical codes and regulations.
- If you are unsure about any part of these instructions, consult an electrician.
- The Decora® DDS15 is not compatible with standard 3-way or 4-way switches. It must be used with the Decora® Digital DD0SR-DL or DD0SR-10 remote for multi-location dimming.

WARNINGS AND CAUTIONS

- Use only (1) Decora Digital DDS15 Switch in a multi-location circuit with up to 9 coordinating remote switches (DD0SR-10) or up to 4 matching remote switches (DD0SR-DL)
- Maximum wire length from dimmer to all installed remotes cannot exceed 300 ft (90m).
- Recommended minimum wall box depth is 2-3/4".
- Use this device **with copper or copper clad wire only**.

DI-000-DDS15-02A

INTRODUCTION

The next generation of lighting control technology is here with the new Decora® Digital Switch with Bluetooth® Technology. This innovative device works using the Leviton Decora® Digital Dimmer & Timer app that can be easily downloaded to smartphones or tablets and paired to the Leviton Switch using Bluetooth® technology. Decora® Digital Devices give users point-to-point local control to automate lighting, bridging the gap between standard switches and whole-house automation systems.

Enjoy the combined functions of a standard wall switch and a countdown or programmable timer switch in one attractive device. Use of the app allows greater flexibility for accurate timer functionality and makes pushing buttons for timed events a tedious chore of the past.

The Leviton Decora® Digital Dimmer & Timer app can be easily downloaded to mobile devices and is compatible with Android and iOS smartphones or tablets. The app is easy to use with simple, intuitive on-screen menu options to independently control Decora® Digital dimmers and switches throughout the home. Decora® Digital Devices are ideal for living rooms, bedrooms, kitchens, dining rooms, home offices, outdoor lighting or anywhere full control of lighting is desired.

FEATURES

- Switch ON/OFF
- ON/OFF LED Indicator
- Three way communication
- Ease of installation – No new wiring

TOOLS NEEDED TO INSTALL YOUR SWITCH

- | | | |
|------------------------------|-----------------|--------|
| Slotted/Phillips Screwdriver | Electrical Tape | Pliers |
| Pencil | Cutters | Ruler |

Changing the color of your Switch:

Your switch includes three color options. The switch ships with the White frame attached. To change color of frame, proceed as follows:

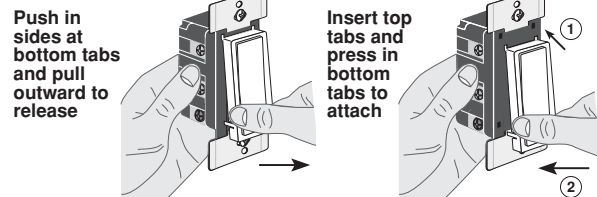

INSTALLING YOUR SWITCH

NOTE: Use check boxes when Steps are completed.

Step 1 **WARNING: TO AVOID FIRE SHOCK OR DEATH; TURN OFF POWER** at circuit breaker or fuse and test that power is off before wiring!

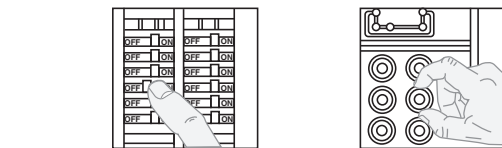

Step 2 **Identifying your wiring application (most common):**

NOTE: If the wiring in your wall box does not resemble any of these configurations, consult an electrician.

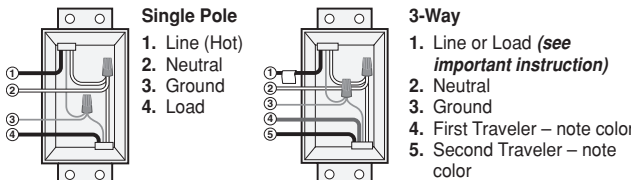

IMPORTANT : For 3-Way applications, note that one of the screw terminals from the old switch being removed will usually be a different color (Black) or labeled Common. Tag that wire with electrical tape and identify as the common (Line or Load) in both the switch wall box and remote wall box.

Step 3 **Preparing and connecting wires:**

This switch can be wired using side wire terminal screws or through backwire openings. Choose appropriate wire stripping specifications accordingly.

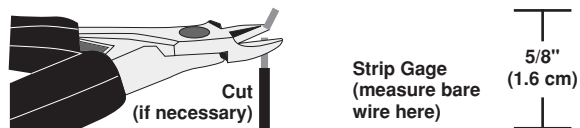

Side Wire Connection
Side wire terminals accept #14-12 AWG solid copper wire only.

Back Wire Connection
Back wire openings accept #14-12 AWG solid copper wire only.

- Make sure that the ends of the wires from the wall box are straight (cut if necessary).
- Remove insulation from each wire in the wall box as shown.
- **For Single-Pole Application, go to Step 4a.**
- **For 3-Way Coordinating Remote (no LED) Application, go to Step 4b.**
- **For 3-Way Matching Remote (with LED) Application, go to Step 4c.**

Step 4a **Single Pole Wiring Application:**

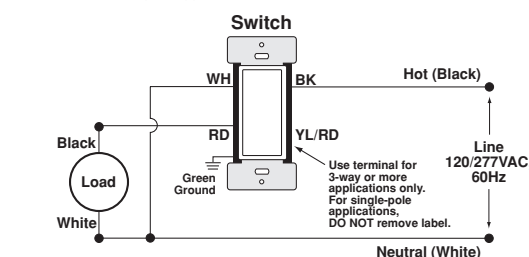
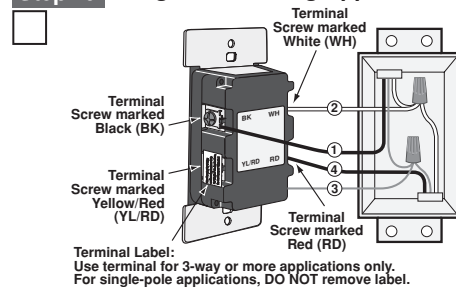

WIRING SWITCH:
Connect wires per **WIRING DIAGRAM** as follows:

- Green or bare copper wire in wall box to Green terminal screw.
 - Line Hot wall box wire to terminal screw marked "BK".
 - Load wall box wire to terminal screw marked "RD".
 - Line Neutral wall box wire to terminal screw marked "WH".
 - Switch terminal screw marked "YL/RD" should have Red insulation label affixed.
- NOTE:** If insulating label is not affixed to terminal screw marked "YL/RD", use electrical tape to cover.

Step 4b **3-Way Wiring with DD0SR-10 Coordinating Remote (no LED) Application:**

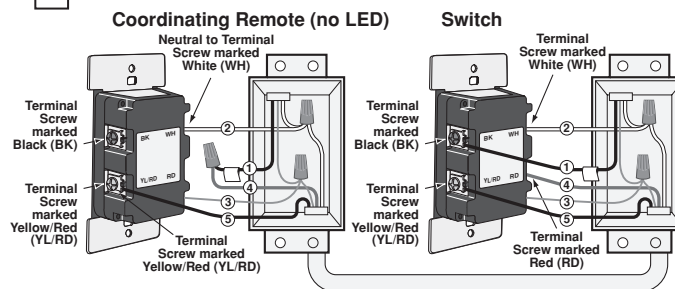

Step 4b cont'd

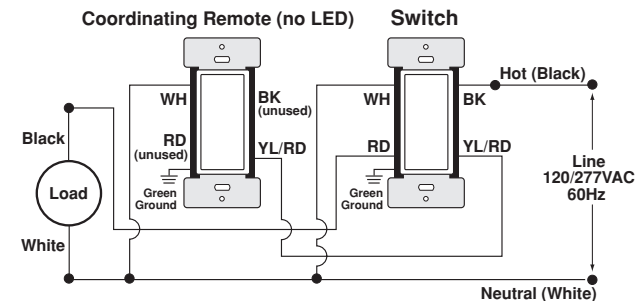

NOTE: The switch must be installed in a wall box that has a Line Hot connection. The coordinating remote must be installed in a wall box with a Load connection and a Neutral connection. A Neutral wire to the coordinating remote needs to be added as shown. If you are unsure about any part of these instructions, consult an electrician.

NOTE: Maximum wire length from switch to all installed remotes cannot exceed 300 ft (90 m).

WIRING SWITCH (wall box with line hot connection):

- Connect wires per WIRING DIAGRAM as follows:**
- Green or bare copper wire in wall box to Green terminal screw.
 - Line Hot (common) wall box wire identified (tagged) when removing old switch to terminal screw marked "BK".
 - First Traveler wall box wire to terminal screw marked "RD" (**note wire color**).
 - Remove Red insulating label from terminal screw marked "YL/RD".
 - Second Traveler wall box wire to terminal screw marked "YL/RD" (**note wire color**). This traveler from the switch must go to the terminal screw on the remote marked "YL/RD".
 - Line Neutral wall box wire to terminal screw marked "WH".

WIRING COORDINATING REMOTE (wall box with load connection):

- Connect wires per WIRING DIAGRAM as follows:**
- NOTE:** "BK" and "RD" terminals on coordinating remote are unused. Tighten both screws.
- Green or bare copper wire in wall box to Green terminal screw.
 - Load wall box wire identified (tagged) when removing old switch to First Traveler (**note color as above**).
 - Second Traveler wall box wire (**note color as above**) to terminal screw marked "YL/RD". This traveler from the remote must go to the terminal screw on the switch marked "YL/RD".
 - Remove White insulating label from terminal screw marked "WH".
 - Line Neutral wall box wire to terminal screw marked "WH".
- Proceed to Step 5.**

Step 4c 3-Way Wiring with DD0SR-DL Matching Remote (with LED) Application:

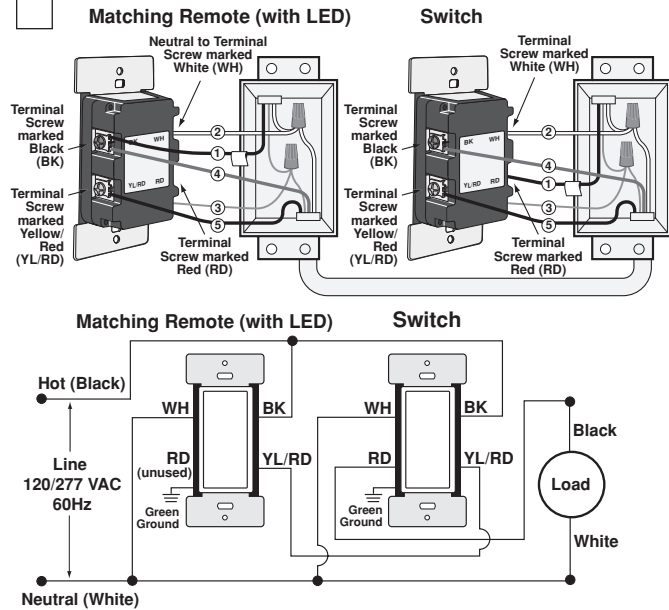

NOTE: The switch **must** be installed in a wall box that has a Load connection. The matching remote must be installed in a wall box with a Line Hot connection and a Neutral connection. A Neutral wire to the matching remote needs to be connected as shown.

If you are unsure about any part of these instructions, consult an electrician.

NOTE: Maximum wire length from switch to all installed remotes cannot exceed 300 ft (90 m).

WIRING MATCHING REMOTE (wall box with line hot connection):

Connect wires per WIRING DIAGRAM as follows:

- NOTE:** "RD" terminal on matching remote is unused. Tighten screw.
- Green or bare copper wire in wall box to Green terminal screw.
 - Line Hot (common) wall box wire identified (tagged) when removing old switch and First Traveler to Remote terminal marked BK.
 - Second Traveler wall box wire from switch to remote terminal screw marked "YL/RD" (**note wire color**). This traveler from the remote must go to Yellow/Red switch terminal screw.
 - Line Neutral wall box to remote terminal screw marked "WH".

WIRING SWITCH (wall box with load connection):

- Connect wires per WIRING DIAGRAM as follows:**
- Green or bare copper wire in wall box to Green terminal screw.
 - Load wall box wire identified (tagged) when removing old switch to Red terminal screw.
 - First Traveler Line Hot to Black terminal screw.
 - Remove Red insulating label from Yellow/Red terminal screw.
 - Second Traveler wall box wire (**note color as above**) to Yellow/Red terminal screw. This traveler from the switch must go to the terminal screw on the remote marked "YL/RD".
 - Line neutral wall box wire to White terminal screw.
 - **Proceed to Step 5.**

Step 5 Testing your Switch prior to mounting in wall box:

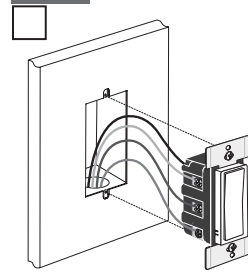

- Position all wires to provide room in outlet wall box for device.
 - Ensure that the word "TOP" is facing up on device strap.
 - Partially screw in mounting screws in wall box mounting holes.
- NOTE:** Dress wires with a bend as shown in diagram in order to relieve stress when mounting device.

- Restore power at circuit breaker or fuse.
- Press pad until locator light is OFF. Lights should turn ON.

If lights do not turn ON, refer to the TROUBLESHOOTING section.

Step 6 Switch Mounting: TURN OFF POWER AT CIRCUIT BREAKER OR FUSE.

Installation may now be completed by tightening mounting screws into wall box. Attach wallplate.

Step 7 Restore Power:

Restore power at circuit breaker or fuse. **Installation is complete.**

OPERATION

NOTE: The locator light will illuminate when the load is in the OFF position to facilitate access in the dark.

Push Pad (Default settings)

Turn ON from OFF position:
Tap top of rocker – Lights turn ON.

Turn OFF from ON position:
Tap bottom of rocker – Lights turn OFF.

If there is a power outage, when the power is restored, the lights will return to the last setting before the power interruption.

Cleaning: Clean with a damp cloth. **DO NOT** use chemical cleaners.

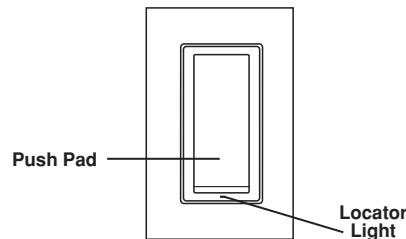

CONTROLLING YOUR DIMMER WITH BLUETOOTH®

Download the Leviton Decora® Digital Switch & Timer App for your device.

Android: Tap the Google Play Store icon on your phone or go to <http://play.google.com> on your computer and follow the instructions to obtain the app.

iPhone: Tap the App Store icon on your phone or access the app through your iTunes account on your computer.

Once you have downloaded the app, follow the instructions on the screen to pair your mobile device with your switch. Once your mobile device is paired, use the following options to control your switch:

- **On - Off:** Turns the switch ON and OFF.
- **Schedule:** Creates distinct ON/OFF events based on time and day.
- **Sleep Timer:** Sets countdown to turn switch OFF.

Advanced Settings

Device Options

- **Randomized Scheduled Events:** Cycles lights ON and OFF to ensure a "lived-in" look while away.
- **Hide Status LED:** Turns Status LED OFF.
- **DST Offset Hours:** Adjusts the Sunrise/Sunset time in hours.
- **DST Offset Minutes:** Adjusts the Sunrise/Sunset time in minutes.

TROUBLESHOOTING

- **Lights Flickering**
 - Lamp has a bad connection.
 - Wires not secured firmly under terminal screws of switch and/or remote.
- **Light does not turn ON and Locator LED does not turn ON**
 - Circuit breaker or fuse has tripped.
 - Lamp is burned out.
 - Neutral not wired to switch (white wire).
 - Lamp Neutral connection is not wired.
- **Remote does not operate lights**
 - Ensure that total wire length does not exceed 300 ft (90 m).
 - Ensure wiring is correct.

For additional information, contact Leviton's Techline at 1-800-824-3005 or visit Leviton's website at www.leviton.com

This product is covered by U.S. Patent No. 8,664,886 and corresponding foreign patents.

FCC COMPLIANCE STATEMENT

This device complies with Part 15 of the FCC Rules. Operation is subject to following two conditions: (1) this device may not cause harmful interference, and (2) this device must accept any interference received, including interference that may cause undesired operation of the device. This equipment has been tested and found to comply with the limits for a Class B Digital Device, pursuant to Part 15 of the FCC Rules. These limits are designed to provide reasonable protection against harmful interference in a residential installation. This equipment generates, uses, and can radiate radio frequency energy and, if not installed and used in accordance with the instructions, may cause harmful interference to radio communications. However, there is no guarantee that interference will not occur in a particular installation. If this equipment does cause harmful interference to radio or television reception, which can be determined by turning the equipment OFF and ON, the user is encouraged to try to correct the interference by one or more of the following measures:

- Reorient or relocate the receiving Antenna.
- Increase the separation between the equipment and the receiver.
- Connect the equipment into an outlet on a circuit different from that to which the receiver is connected.
- Consult the dealer or an experienced radio/tv technician for help.

FCC CAUTION

Any changes or modifications not expressly approved by Leviton Manufacturing Co., Inc., could void the user's authority to operate the equipment.

IC COMPLIANCE STATEMENT

This device complies with Industry Canada licence-exempt RSS standard(s). Operation is subject to the following two conditions: (1) this device may not cause interference, and (2) this device must accept any interference, including interference that may cause undesired operation of the device.

Copyright and Trademark Information

The Bluetooth® word mark and logos are registered trademarks owned by Bluetooth SIG, Inc., used under license by Leviton. Use herein of third party trademarks, service marks, trade names, brand names and/or product names are for informational purposes only, are/may be the trademarks of their respective owners; such use is not meant to imply affiliation, sponsorship, or endorsement.

No part of this document may be reproduced, transmitted or transcribed without the express written permission of Leviton Manufacturing Co., Inc.